

Sensor/actuator cable - SAC-4P-M12MS/0,6-PUR/M 8FS



1693076

<https://www.phoenixcontact.com/pc/products/1693076>

Please be informed that the data shown in this PDF document is generated from our Online Catalog. Please find the complete data in the user documentation. Our General Terms of Use for Downloads are valid.



Sensor/actuator cable, 4-position, PUR halogen-free, black-gray RAL 7021, Plug straight M12, coding: A, on Socket straight M8, coding: A, cable length: 0.6 m

Your advantages

- Easy and safe: 100% electrically tested plug-in components

Commercial Data

Item number	1693076
Packing unit	1 pc
Minimum order quantity	1 pc
Sales Key	02
Product Key	BF1CCA
Catalog Page	Page 194 (C-2-2019)
GTIN	4017918187064
Weight per Piece (including packing)	26.36 g
Weight per Piece (excluding packing)	21.845 g
Customs tariff number	85444290
Country of origin	DE

Sensor/actuator cable - SAC-4P-M12MS/0,6-PUR/M 8FS



1693076

<https://www.phoenixcontact.com/pc/products/1693076>

Technical Data

Product properties

Product type	Sensor/actuator cable
Number of positions	4
Application	Standard
No. of cable outlets	1
Shielded	no
Coding	A - standard

Insulation characteristics

Overvoltage category	II
Degree of pollution	3

Material specifications

Flammability rating according to UL 94	HB
Sealing material	NBR
Material of grip body	TPU, hardly inflammable, self-extinguishing
Contact material	CuSn
Contact surface material	Ni/Au
Contact carrier material	TPU GF
Material for screw connection	Zinc die-cast, nickel-plated

Electrical properties

Contact resistance	$\leq 5 \text{ m}\Omega$
Insulation resistance	$\geq 100 \text{ M}\Omega$
Nominal voltage U_N	48 V AC
	60 V DC
Nominal current I_N	4 A
Protective circuit	unwired

Mechanical properties

Mechanical data

Insertion/withdrawal cycles	≥ 100
-----------------------------	------------

LED signaling

Status display	No
Status display present	No

Connection data

Conductor connection

Tightening torque	0.4 Nm (M12 connector)
	0.2 Nm (M8 connectors)

Sensor/actuator cable - SAC-4P-M12MS/0,6-PUR/M 8FS



1693076

<https://www.phoenixcontact.com/pc/products/1693076>

Connector

Connection 1

Head design	Plug
Head cable outlet	straight
Head thread type	M12
Coding	A

Connection 2

Head design	Socket
Head cable outlet	straight
Head thread type	M8
Coding	A

Cable / line

Cable length	0.6 m
--------------	-------

PUR halogen-free black [PUR]

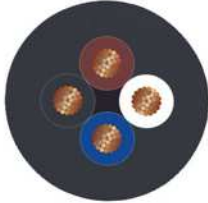
Dimensional drawing	
Cable weight	23 kg/km
UL AWM Style	20549 / 10493 (80°C/300 V)
Number of positions	4
Shielded	no
Cable type	PUR halogen-free black [PUR]
Conductor structure signal line	32x 0.10 mm
AWG signal line	24
Conductor cross section	4x 0.25 mm ² (Signal line)
Wire diameter incl. insulation	1.17 mm ±0.02 mm (Signal line)
External cable diameter	3.95 mm ±0.15 mm
Outer sheath, material	PUR
External sheath, color	black-gray RAL 7021
Conductor material	Bare Cu litz wires
Material wire insulation	PP
Single wire, color	brown, white, blue, black
Thickness, insulation	≥ 0.21 mm (Core insulation) approx. 0.5 mm (Outer cable sheath)
Overall twist	4 wires, twisted

Sensor/actuator cable - SAC-4P-M12MS/0,6-PUR/M 8FS



1693076

<https://www.phoenixcontact.com/pc/products/1693076>

Max. conductor resistance	max. 78 Ω/km (at 20 °C)
Insulation resistance	≥ 100 GΩ*km (at 20 °C)
Nominal voltage, cable	≤ 300 V
Test voltage	≥ 3000 V
Smallest bending radius, fixed installation	20 mm
Smallest bending radius, movable installation	40 mm
Max. bending cycles	10000000
Halogen-free	in accordance with DIN VDE 0472 part 815
Flame resistance	in accordance with UL 758/1581 FT2 DIN EN 60332-2-2 (20 s)
Resistance to oil	in accordance with DIN EN 60811-2-1
Other resistance	Highly resistant to acids, alkaline solutions and solvents hydrolysis and microbe resistant partly UV-resistant in accordance with DIN EN ISO 4892-2-A
Special properties	Flexible cable conduit capable Silicone-free Free of substances which would hinder coating with paint or varnish
Ambient temperature (operation)	-40 °C ... 80 °C (cable, fixed installation) -25 °C ... 80 °C (Cable, flexible installation)

Ambient conditions

Degree of protection	IP65
	IP67
	IP68
Ambient temperature (operation)	-25 °C ... 90 °C (Plug / socket)

Standards and regulations

Standards/specifications	IEC 61076-2-101
Standards/specifications	IEC 61076-2-104

Sensor/actuator cable - SAC-4P-M12MS/0,6-PUR/M 8FS



1693076

<https://www.phoenixcontact.com/pc/products/1693076>

Drawings

Schematic diagram

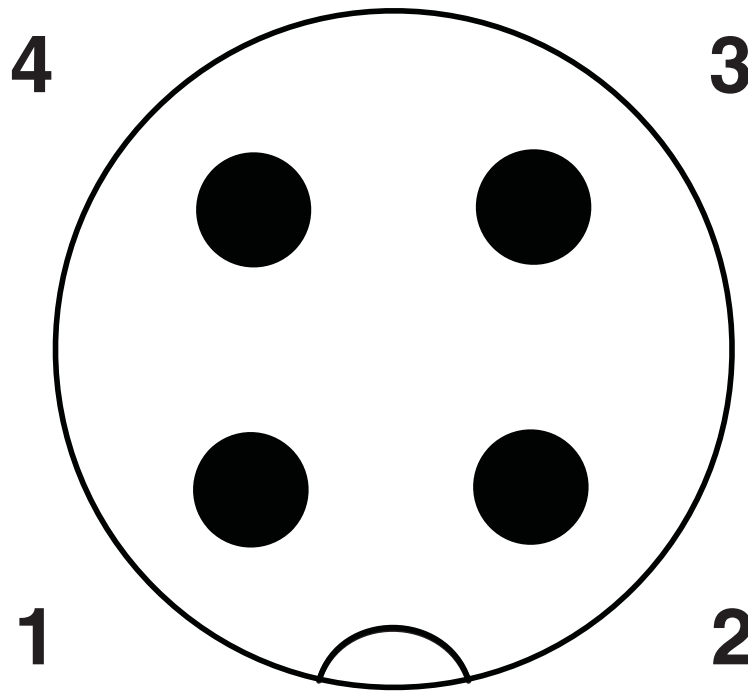

Pin assignment M12 plug, 4-pos., A-coded, view plug side

Dimensional drawing

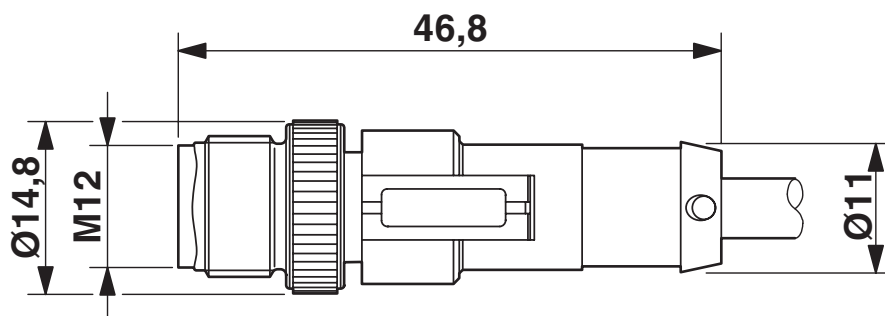

Plug, M12 x 1, straight, shielded

Sensor/actuator cable - SAC-4P-M12MS/0,6-PUR/M 8FS



1693076

<https://www.phoenixcontact.com/pc/products/1693076>

Schematic diagram

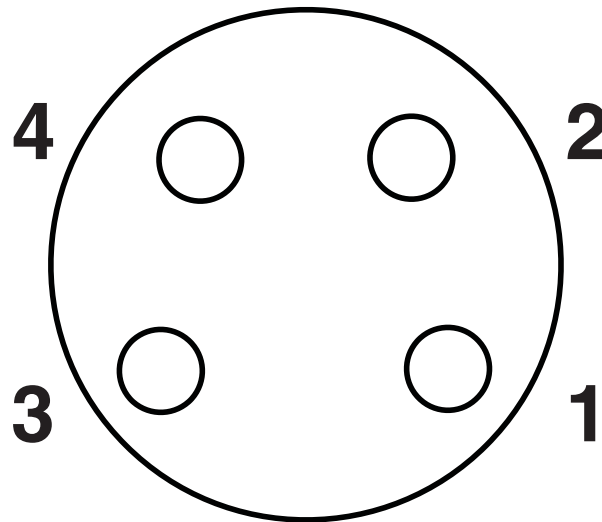

Pin assignment M8 socket, 4-pos., view female side

Circuit diagram

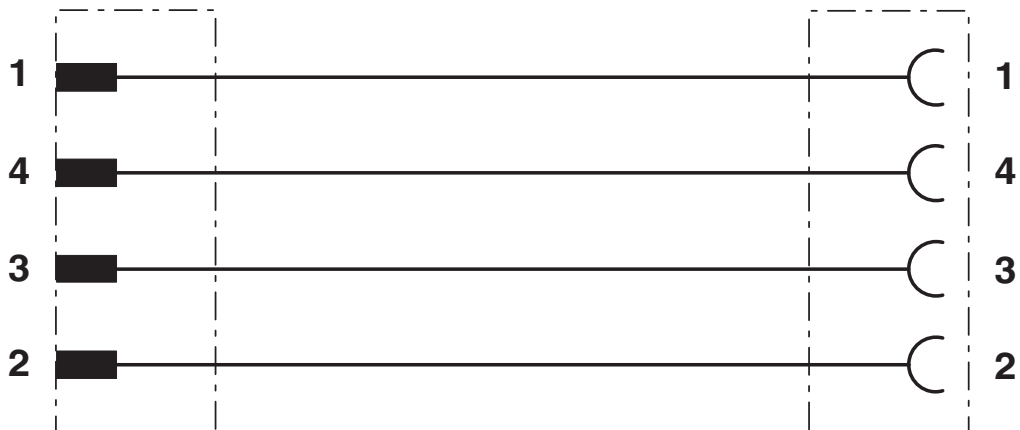

Sensor/actuator cable - SAC-4P-M12MS/0,6-PUR/M 8FS



1693076

<https://www.phoenixcontact.com/pc/products/1693076>

Dimensional drawing

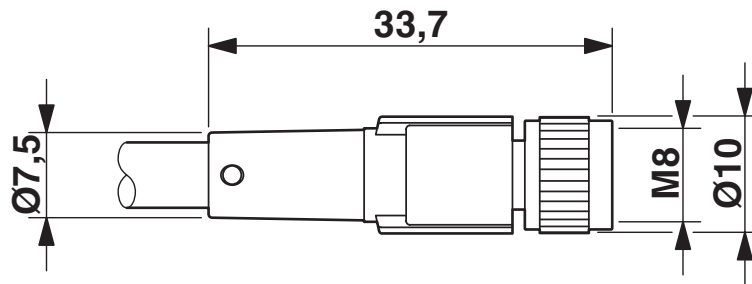

Socket M8 x 1, straight

Sensor/actuator cable - SAC-4P-M12MS/0,6-PUR/M 8FS



1693076

<https://www.phoenixcontact.com/pc/products/1693076>

Approvals

 UL Listed Approval ID: FILE E 221474				
	Nominal Voltage U_N	Nominal Current I_N	Cross Section AWG	Cross Section mm^2
	30 V	4 A	-	-

 cUL Listed Approval ID: FILE E 221474				
	Nominal Voltage U_N	Nominal Current I_N	Cross Section AWG	Cross Section mm^2
	30 V	4 A	-	-

 EAC Approval ID: RU D-DE.HB35.B.00387	
---	--

cULus Listed

Sensor/actuator cable - SAC-4P-M12MS/0,6-PUR/M 8FS



1693076

<https://www.phoenixcontact.com/pc/products/1693076>

Classifications

ECLASS

ECLASS-9.0	27060311
ECLASS-10.0.1	27060311
ECLASS-11.0	27060311

ETIM

ETIM 8.0	EC001855
----------	----------

UNSPSC

UNSPSC 21.0	26121600
-------------	----------

Sensor/actuator cable - SAC-4P-M12MS/0,6-PUR/M 8FS



1693076

<https://www.phoenixcontact.com/pc/products/1693076>

Environmental Product Compliance

China RoHS	Environmentally friendly use period: unlimited = EFUP-e
	No hazardous substances above threshold values

Sensor/actuator cable - SAC-4P-M12MS/0,6-PUR/M 8FS



1693076

<https://www.phoenixcontact.com/pc/products/1693076>

Accessories

Sealing cap

Sealing cap - PROT-M12 FS-PA-CHAIN - 1430873

<https://www.phoenixcontact.com/pc/products/1430873>

M12 sealing cap made of plastic with fixing band, for sensor cables, for free M12 plugs



Locking clip

Locking clip - SAC-M12-EXCLIP-M - 1558988

<https://www.phoenixcontact.com/pc/products/1558988>

Locking clip for the pin side of sensor/actuator cables with M12 connector and M12 connectors for assembly, for knurl diameter: 15 mm or for Allen key with a wrench size of 14 mm, prevents the disconnection of plug-in connections without tools



Sensor/actuator cable - SAC-4P-M12MS/0,6-PUR/M 8FS



1693076

<https://www.phoenixcontact.com/pc/products/1693076>

Insert label

Insert label - PABA WH/23 - 1013779

<https://www.phoenixcontact.com/pc/products/1013779>



Insert label, Strip, white, unlabeled, can be labeled with: CMS-P1-PLOTTER, mounting type: slide-on, cable diameter range: 1.5 ... 35 mm, lettering field size: 23 x 4 mm, Number of individual labels: 20

Insert label

Insert label - PABA YE/23 - 1013782

<https://www.phoenixcontact.com/pc/products/1013782>



Insert label, Strip, yellow, unlabeled, can be labeled with: CMS-P1-PLOTTER, mounting type: slide-on, cable diameter range: 1.5 ... 35 mm, lettering field size: 23 x 4 mm, Number of individual labels: 20

Sensor/actuator cable - SAC-4P-M12MS/0,6-PUR/M 8FS



1693076

<https://www.phoenixcontact.com/pc/products/1693076>

Marker pen

Marker pen - B-STIFT - 1051993

<https://www.phoenixcontact.com/pc/products/1051993>



Marker pen, for manual labeling of unprinted Zack strips, smear-proof and waterproof, line thickness 0.5 mm

Screw plug

Screw plug - PROT-M 8 MS-PA-CHAIN - 1430860

<https://www.phoenixcontact.com/pc/products/1430860>

M8 sealing cap made of plastic with fixing band for sensor cables, for M8 sockets



Sensor/actuator cable - SAC-4P-M12MS/0,6-PUR/M 8FS



1693076

<https://www.phoenixcontact.com/pc/products/1693076>

Torque screwdriver

Torque screwdriver - TSD 02 SAC - 1208487

<https://www.phoenixcontact.com/pc/products/1208487>



Torque screwdriver, with preset torque of 0.2 Nm and 4 mm hexagonal drive for M8 connectors

Tool

Tool - SAC BIT M8-D10 - 1208461

<https://www.phoenixcontact.com/pc/products/1208461>



Nut for assembling M8 connectors with longitudinal knurl and a knurl diameter of 10 mm, for 4 mm hexagonal drive

Sensor/actuator cable - SAC-4P-M12MS/0,6-PUR/M 8FS



1693076

<https://www.phoenixcontact.com/pc/products/1693076>

Torque screwdriver

Torque screwdriver - TSD 04 SAC - 1208429

<https://www.phoenixcontact.com/pc/products/1208429>



Torque screwdriver, with preset torque of 0.4 Nm and 4 mm hexagonal drive for M12 connectors

Torque screwdriver

Torque screwdriver - TSD-M 1,2NM - 1212224

<https://www.phoenixcontact.com/pc/products/1212224>



Torque screw driver, accuracy as per EN ISO 6789 standard, adjustable from 0.3 - 1.2 Nm

Sensor/actuator cable - SAC-4P-M12MS/0,6-PUR/M 8FS



1693076

<https://www.phoenixcontact.com/pc/products/1693076>

Adapter insert

Adapter insert - TSD-M SAC-BIT ADAPTER - 1212600

<https://www.phoenixcontact.com/pc/products/1212600>



Adapter bit for TSD-M...torque tools, E6.3-1/4" drive with 4 mm hexagon to accommodate SAC bits

Tool

Tool - SAC BIT M12-D15 - 1208432

<https://www.phoenixcontact.com/pc/products/1208432>



Nut for assembling sensor/actuator cables with M12 connector and M12 connectors for assembly, with a knurl diameter of 15 mm, for 4 mm hexagonal drive

Phoenix Contact 2022 © - all rights reserved
<https://www.phoenixcontact.com>

PHOENIX CONTACT GmbH & Co. KG
Flachsmarktstraße 8
D-32825 Blomberg
+49 (0) 5235-3 00
info@phoenixcontact.com