

Single relay - REL-MR- 18DC/21

2961383

<https://www.phoenixcontact.com/il/products/2961383>



Please be informed that the data shown in this PDF document is generated from our Online Catalog. Please find the complete data in the user documentation. Our General Terms of Use for Downloads are valid.

Plug-in miniature power relay, with power contact, 1 changeover contact, input voltage 18 V DC

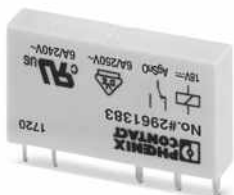

Your advantages

- Safe isolation according to DIN EN 50178 between coil and contact
- High degree of protection up to RT III depending on type (wash-proof)
- Power contacts up to 6 A

Single relay - REL-MR- 18DC/21



2961383

<https://www.phoenixcontact.com/il/products/2961383>

Commercial Data

Item number	2961383
Packing unit	10 pc
Minimum order quantity	10 pc
Sales Key	08
Product Key	CK6195
Catalog Page	Page 394 (C-5-2019)
GTIN	4017918936419
Weight per Piece (including packing)	6.659 g
Weight per Piece (excluding packing)	4.91 g
Customs tariff number	85364190
Country of origin	CZ

Single relay - REL-MR- 18DC/21



2961383

<https://www.phoenixcontact.com/il/products/2961383>

Technical Data

Product properties

Product type	Single relay
Operating mode	100% operating factor
Mechanical service life	2x 10 ⁷ cycles

Insulation characteristics

Overvoltage category	III
Pollution degree	3

Electrical properties

Maximum power dissipation for nominal condition	0.16 W
---	--------

Input data

Coil side

Nominal input voltage U _N	18 V DC
Input voltage range	10.8 V DC ... 49.5 V DC
Typical input current at U _N	9 mA
Typical response time	5 ms
Typical release time	2.5 ms
Coil resistance	1906 Ω ±10 % (at 20 °C)

Output data

Switching

Contact type	1 changeover contact
Type of switch contact	Single contact
Drive and function	monostable
Contact material	AgSnO
Maximum switching voltage	250 V AC/DC
Minimum switching voltage	5 V (at 100 mA)
Limiting continuous current	6 A
Maximum inrush current	10 A (4 s)
Min. switching current	10 mA (at 12 V)
Interrupting rating (ohmic load) max.	140 W (at 24 V DC) 20 W (at 48 V DC) 18 W (at 60 V DC) 23 W (at 110 V DC) 40 W (at 220 V DC) 1500 VA (for 250 V AC)
Switching capacity	2 A (at 24 V, DC13) 0.2 A (at 110 V, DC13) 0.1 A (at 220 V, DC13)

Single relay - REL-MR- 18DC/21

2961383

<https://www.phoenixcontact.com/il/products/2961383>

Motor load according to UL 508	3 A (at 24 V, AC15)
	3 A (at 120 V, AC15)
	3 A (at 230 V, AC15)
	1/4 HP, 240 - 277 V AC (N/O contact)
	1/6 HP, 240 - 277 V AC (N/C contact)

Connection data

Connection method	Solder connection
-------------------	-------------------

Dimensions

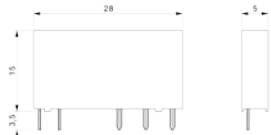
Dimensional drawing	
Width	5 mm
Height	28 mm
Depth	15 mm

Environmental and real-life conditions

Ambient conditions

Degree of protection	RT III
Ambient temperature (operation)	-40 °C ... 85 °C
Ambient temperature (storage/transport)	-40 °C ... 85 °C

Approval data

Corrosive gas test

Identification	ISA-S71.04. G3 Harsh Group
	EN 60068-2-60

Standards and regulations

Standards/regulations	IEC 60664
	EN 50178
	EN 61810-1

Drawings

Drilling plan/solder pad geometry

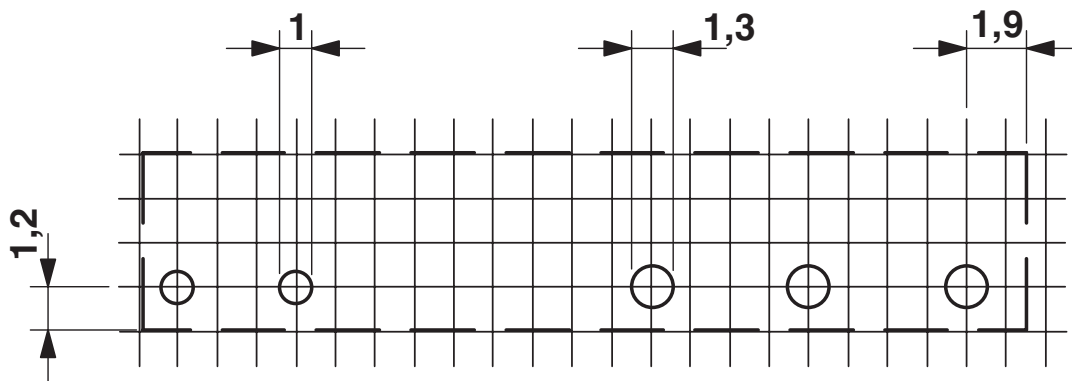

a = pitch division 1.25 mm and 1.27 mm

Diagram

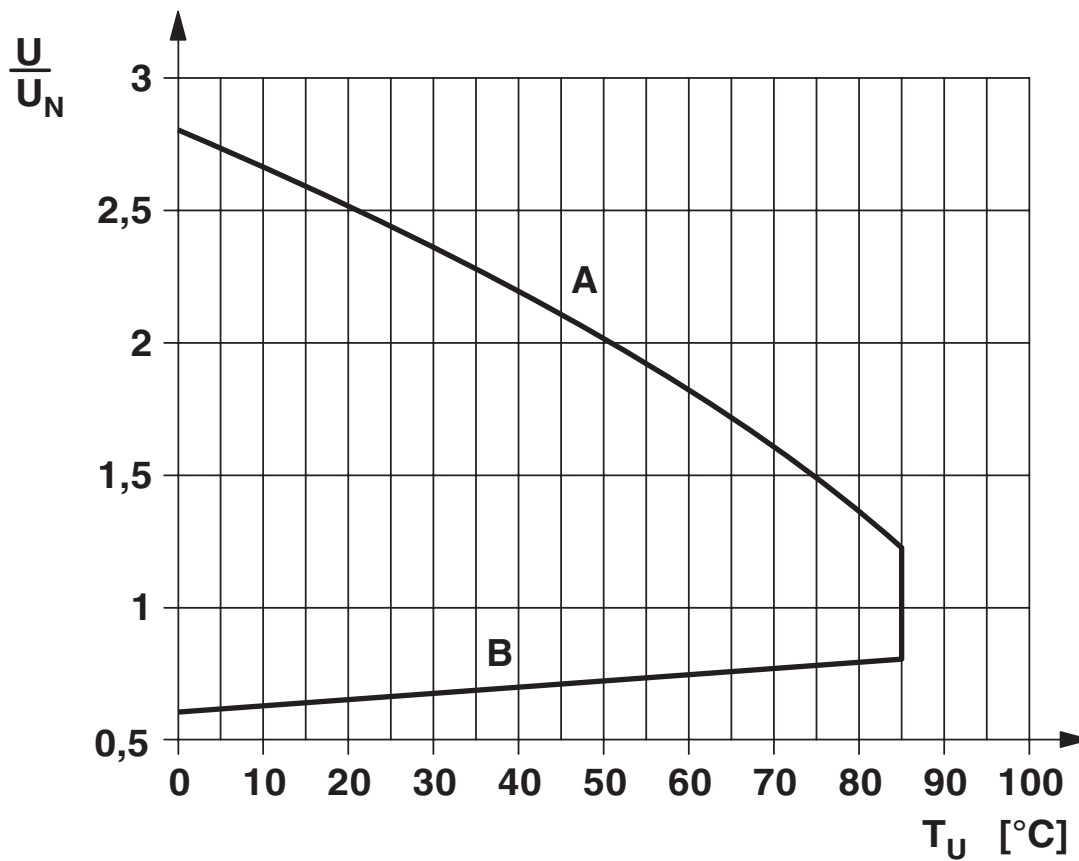

Single relay - REL-MR- 18DC/21

2961383

<https://www.phoenixcontact.com/il/products/2961383>

Diagram

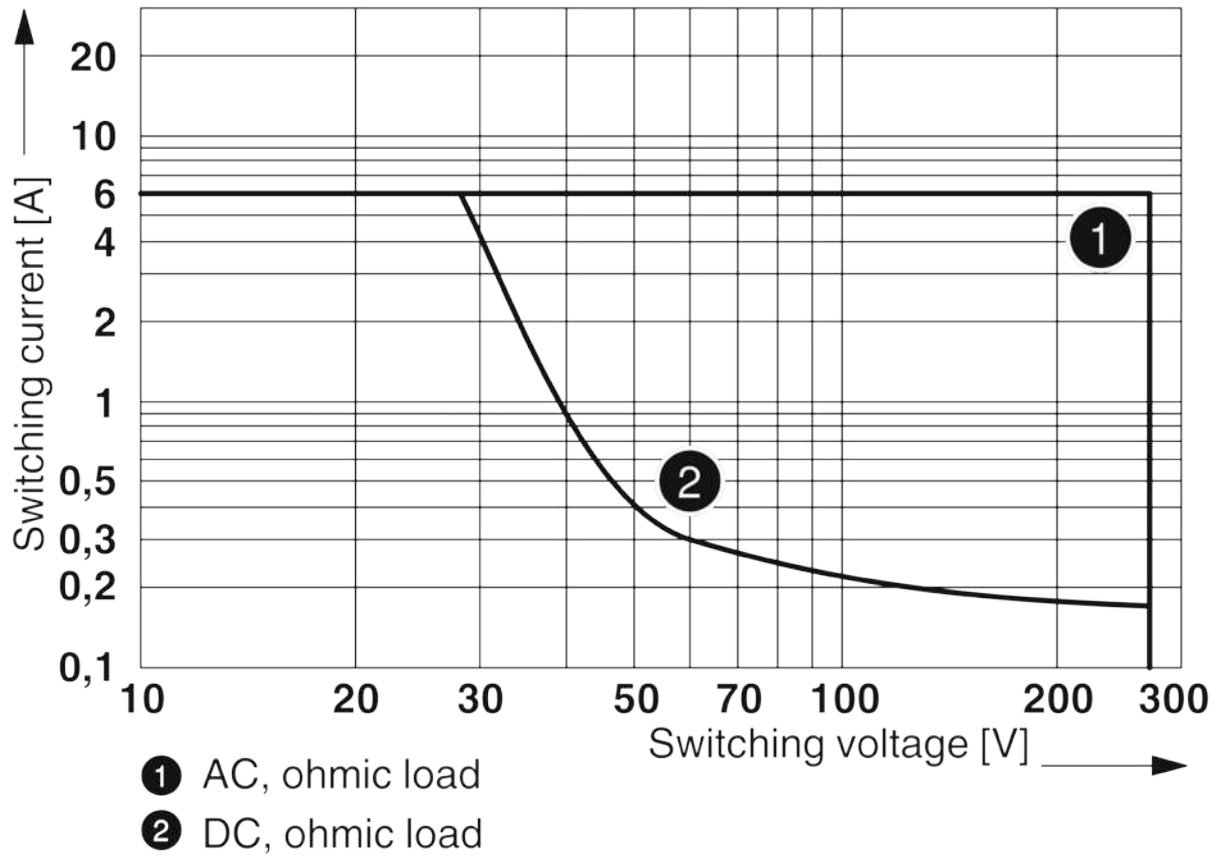

Interrupting rating

Circuit diagram

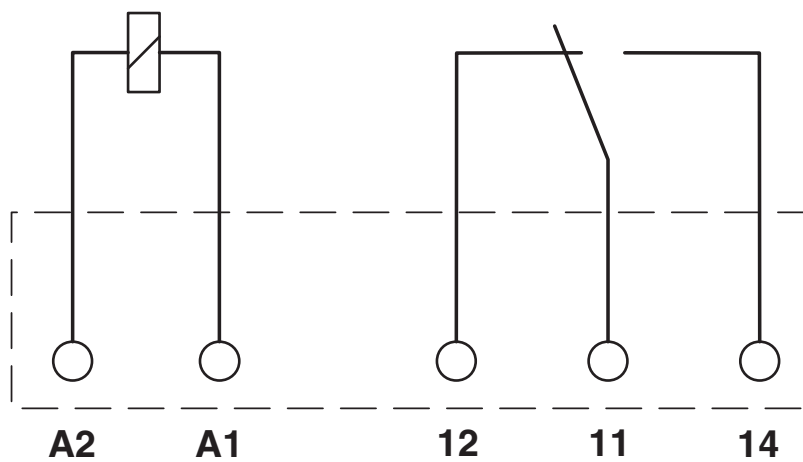

Single relay - REL-MR- 18DC/21

2961383

<https://www.phoenixcontact.com/il/products/2961383>

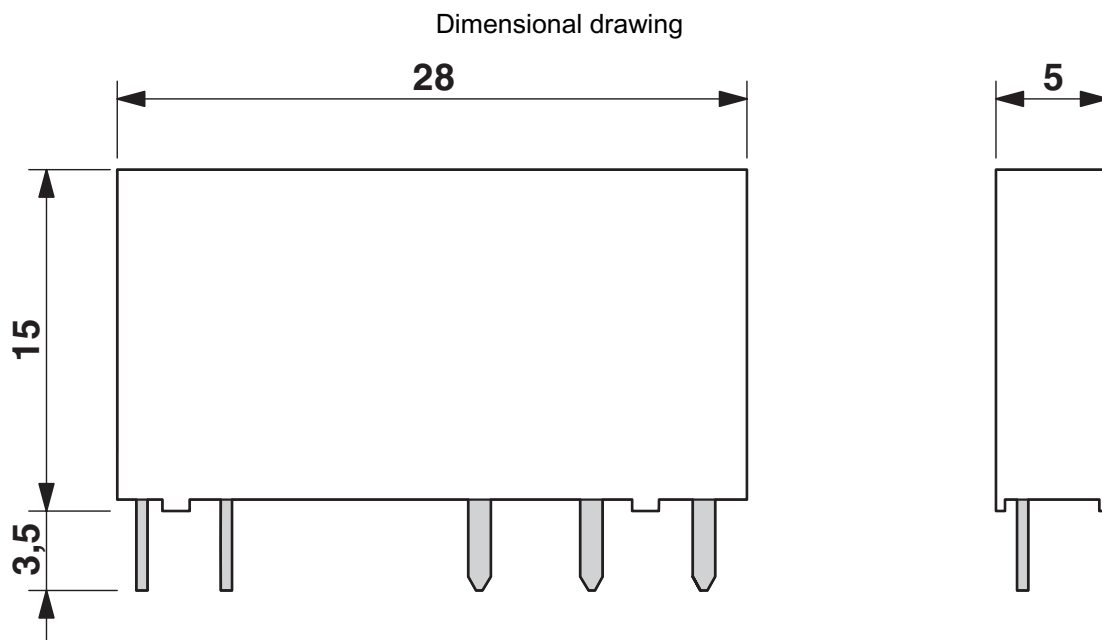

Single relay - REL-MR- 18DC/21



2961383

<https://www.phoenixcontact.com/il/products/2961383>

Approvals



cUL Recognized
Approval ID: FILE E 172140



UL Recognized
Approval ID: FILE E 172140



EAC
Approval ID: TR_TS_D_00573_c



UL Recognized
Approval ID: FILE E 172140



EAC
Approval ID: RU*C-DE.*08.B.00010



VDE Zeichengenehmigung
Approval ID: 40010212

	Nominal Voltage U_N	Nominal Current I_N	Cross Section AWG	Cross Section mm^2
Reports with production monitoring			-	-



VDE Zeichengenehmigung
Approval ID: 40032864

	Nominal Voltage U_N	Nominal Current I_N	Cross Section AWG	Cross Section mm^2
Mark approval certificate			-	-



cUL Recognized
Approval ID: FILE E 172140



VDE Zeichengenehmigung
Approval ID: 40054426

Single relay - REL-MR- 18DC/21



2961383

<https://www.phoenixcontact.com/il/products/2961383>

Classifications

ECLASS

ECLASS-9.0	27371601
ECLASS-10.0.1	27371601
ECLASS-11.0	27371601

ETIM

ETIM 8.0	EC001437
----------	----------

UNSPSC

UNSPSC 21.0	39122300
-------------	----------

Single relay - REL-MR- 18DC/21

2961383

<https://www.phoenixcontact.com/il/products/2961383>



Environmental Product Compliance

China RoHS	Environmentally friendly use period: unlimited = EFUP-e
	No hazardous substances above threshold values

Single relay - REL-MR- 18DC/21

2961383

<https://www.phoenixcontact.com/il/products/2961383>



Accessories

Relay base

Relay base - PLC-BPT- 24DC/21RW - 2900261

<https://www.phoenixcontact.com/il/products/2900261>



6.2 mm PLC basic terminal block for railway applications with Push-in connection, without relay or solid-state relay, range from $0.7 \times U_N$ to $1.25 \times U_N$, temperature range from -25°C to $+70^\circ\text{C}$, 1 changeover contact, input voltage 24 V DC

Phoenix Contact 2022 © - all rights reserved
<https://www.phoenixcontact.com>

PHOENIX CONTACT Israel Ltd.
P.O.B. 1799 Industrial Park Hasharon
Quadima 60920
+972-9-8915700
info@phoenixcontact.co.il