

# Solid-state relay terminal block - DEK-OV- 5DC/ 24DC/ 10



2961752

<https://www.phoenixcontact.com/pc/products/2961752>

Please be informed that the data shown in this PDF document is generated from our Online Catalog. Please find the complete data in the user documentation. Our General Terms of Use for Downloads are valid.



Power solid-state relay terminal block, input: DC voltage, output: DC voltage, input voltage: 5 V DC

## Your advantages

- Actuator version available
- EB-DIK insertion bridges
- Labeling and mounting with user-friendly modular terminal blocks
- Wear-free switching of up to 24 V DC/10 A or 240 V AC/800 mA
- Integrated output protective circuit
- Zero voltage switch at AC output
- Electrical isolation between input and output at up to 2.5 kVrms
- Status indicator
- Integrated input circuit

## Commercial Data

Item number	2961752
Packing unit	10 pc
Minimum order quantity	1 pc
Product Key	CK61D2
Catalog Page	Page 443 (C-5-2019)
GTIN	4017918927950
Weight per Piece (including packing)	25.38 g
Weight per Piece (excluding packing)	25 g
Customs tariff number	85364190
Country of origin	CN

# Solid-state relay terminal block - DEK-OV- 5DC/ 24DC/ 10



2961752

<https://www.phoenixcontact.com/pc/products/2961752>

## Technical Data

### Notes

Order information:	The housing is open on one side. The appropriate cover is D-DEK 1,5 GN (2716949).
Note on application	Use of EB 80-DIK... bridges in the DEK terminal blocks: Absorption of humidity from the ambient air as well as an unfavorable tolerance between a larger number of DEK terminal blocks and the EB 80-DIK... bridge may cause (minor) expansion of the DEK housing. When the EB 80-DIK... bridges are used, therefore, it is recommended that these be disconnected after about 10 to 12 DEK terminal blocks and a wire bridge to the next DEK terminal block be inserted in their place.

### Product properties

Product type	Solid-state relay module
Application	Output function
Operating mode	100% operating factor

### Insulation characteristics

Overvoltage category	III
Pollution degree	2
Insulation	Basic insulation

### Electrical properties

Test voltage Input/output	2.5 kV AC (50 Hz, 1 min., input/output)
---------------------------	---

### Input data

Nominal input voltage $U_N$	5 V DC
Input voltage range in reference to $U_N$	0.8 ... 1.2
Input voltage range	4 V DC ... 6 V DC
Switching threshold "0" signal in reference to $U_N$	$\leq 0.4$
Switching threshold "1" signal in reference to $U_N$	$\geq 0.8$
Typical input current at $U_N$	5.1 mA
Typical response time	250 $\mu$ s
Typical turn-off time	800 $\mu$ s
Operating voltage display	Yellow LED
Protective circuit	Reverse polarity protection Surge protection
Transmission frequency	100 Hz

### Output data

Contact type	1 N/O contact
Design of digital output	electronic
Output voltage range	5 V DC ... 30 V DC
Limiting continuous current	10 A (see derating curve)

# Solid-state relay terminal block - DEK-OV- 5DC/ 24DC/ 10



2961752

<https://www.phoenixcontact.com/pc/products/2961752>

Surge current	100 A (t = 20 ms)
Voltage drop at max. limiting continuous current	< 50 mV
Output circuit	3-conductor, ground-referenced
Protective circuit	Reverse polarity protection
	Surge protection

## Connection data

Connection method	Screw connection
Stripping length	8 mm
Screw thread	M3
Conductor cross section solid	0.2 mm <sup>2</sup> ... 2.5 mm <sup>2</sup>
Conductor cross section flexible	0.2 mm <sup>2</sup> ... 2.5 mm <sup>2</sup>
Conductor cross section AWG	24 ... 14
Tightening torque	0.5 Nm

## Dimensions

Width	6.2 mm
Height	80 mm
Depth	56 mm

## Environmental and real-life conditions

### Ambient conditions

Ambient temperature (operation)	-20 °C ... 60 °C
Ambient temperature (storage/transport)	-20 °C ... 70 °C

## Standards and regulations

### Standards/regulations

Standards/regulations	IEC 60947-5-1
-----------------------	---------------

## Mounting

Mounting type	DIN rail mounting
Assembly instructions	in rows with zero spacing
Mounting position	any

# Solid-state relay terminal block - DEK-OV- 5DC/ 24DC/ 10

2961752

<https://www.phoenixcontact.com/pc/products/2961752>

## Drawings

Diagram

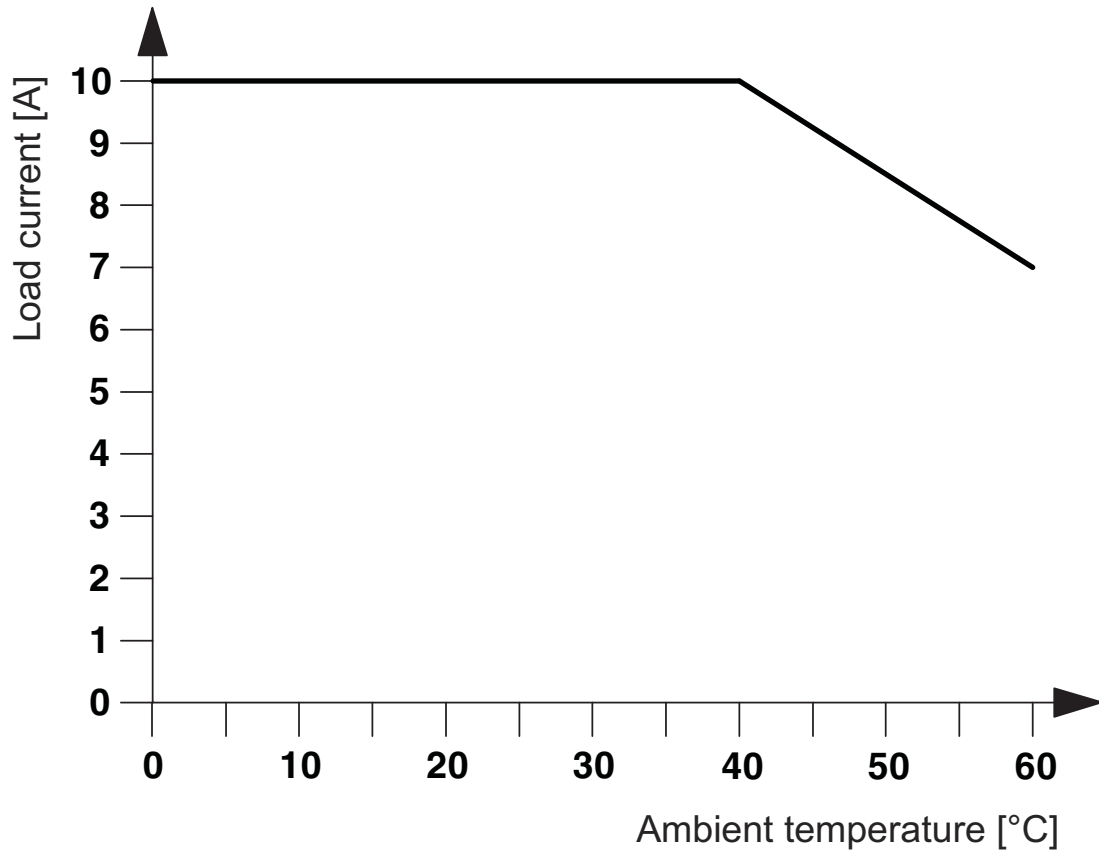

Circuit diagram

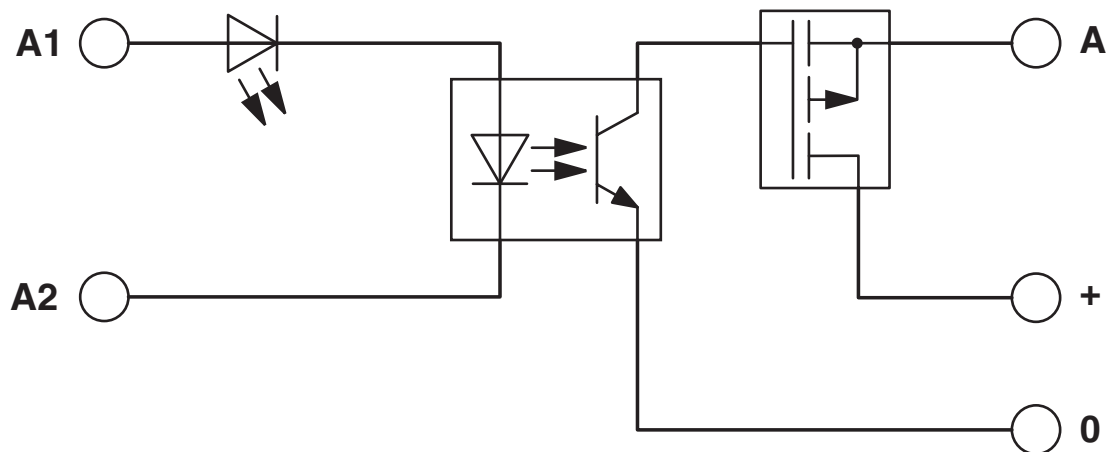

# Solid-state relay terminal block - DEK-OV- 5DC/ 24DC/ 10



2961752

<https://www.phoenixcontact.com/pc/products/2961752>

## Approvals



**cUL Recognized**  
Approval ID: FILE E 238705



**UL Recognized**  
Approval ID: FILE E 238705



**EAC**  
Approval ID: TR\_TS\_D\_00573\_c

**cULus Recognized**

# Solid-state relay terminal block - DEK-OV- 5DC/ 24DC/ 10



2961752

<https://www.phoenixcontact.com/pc/products/2961752>

## Classifications

### ECLASS

ECLASS-9.0	27371604
ECLASS-10.0.1	27371604
ECLASS-11.0	27371604

### ETIM

ETIM 8.0	EC001504
----------	----------

### UNSPSC

UNSPSC 21.0	39122300
-------------	----------

# Solid-state relay terminal block - DEK-OV- 5DC/ 24DC/ 10



2961752

<https://www.phoenixcontact.com/pc/products/2961752>

## Environmental Product Compliance

REACH SVHC	Lead 7439-92-1
China RoHS	Environmentally Friendly Use Period = 50 years
	For information on hazardous substances, refer to the manufacturer's declaration available under "Downloads"

# Solid-state relay terminal block - DEK-OV- 5DC/ 24DC/ 10

2961752

<https://www.phoenixcontact.com/pc/products/2961752>

## Accessories

 Note: Applying some accessories below might limit this product.

### Insertion bridge

Insertion bridge - EB 2- DIK RD - 2716693

<https://www.phoenixcontact.com/pc/products/2716693>



Insertion bridge, pitch: 6.15 mm, color: red

 Max. current carrying capacity: 26 A

### Insertion bridge

Insertion bridge - EB 3- DIK RD - 2716745

<https://www.phoenixcontact.com/pc/products/2716745>



Insertion bridge, pitch: 6.15 mm, color: red

 Max. current carrying capacity: 26 A

# Solid-state relay terminal block - DEK-OV- 5DC/ 24DC/ 10

2961752

<https://www.phoenixcontact.com/pc/products/2961752>

## Insertion bridge

Insertion bridge - EB 4- DIK RD - 2716758

<https://www.phoenixcontact.com/pc/products/2716758>



Insertion bridge, pitch: 6.15 mm, color: red

 Max. current carrying capacity: 26 A

---

## Insertion bridge

Insertion bridge - EB 5- DIK RD - 2716761

<https://www.phoenixcontact.com/pc/products/2716761>



Insertion bridge, pitch: 6.15 mm, color: red

 Max. current carrying capacity: 26 A

# Solid-state relay terminal block - DEK-OV- 5DC/ 24DC/ 10

2961752

<https://www.phoenixcontact.com/pc/products/2961752>

## Insertion bridge

Insertion bridge - EB 10- DIK RD - 2716774

<https://www.phoenixcontact.com/pc/products/2716774>



Insertion bridge, pitch: 6.15 mm, color: red

 Max. current carrying capacity: 26 A

---

## Insertion bridge

Insertion bridge - EB 2- DIK BU - 2716648

<https://www.phoenixcontact.com/pc/products/2716648>



Insertion bridge, pitch: 6.15 mm, color: blue

 Max. current carrying capacity: 26 A

# Solid-state relay terminal block - DEK-OV- 5DC/ 24DC/ 10

2961752

<https://www.phoenixcontact.com/pc/products/2961752>

## Insertion bridge

Insertion bridge - EB 3- DIK BU - 2716651

<https://www.phoenixcontact.com/pc/products/2716651>

Insertion bridge, pitch: 6.15 mm, color: blue



 Max. current carrying capacity: 26 A

---

## Insertion bridge

Insertion bridge - EB 4- DIK BU - 2716664

<https://www.phoenixcontact.com/pc/products/2716664>

Insertion bridge, pitch: 6.15 mm, color: blue



 Max. current carrying capacity: 26 A

# Solid-state relay terminal block - DEK-OV- 5DC/ 24DC/ 10

2961752

<https://www.phoenixcontact.com/pc/products/2961752>

## Insertion bridge

Insertion bridge - EB 5- DIK BU - 2716677

<https://www.phoenixcontact.com/pc/products/2716677>

Insertion bridge, pitch: 6.15 mm, color: blue



 Max. current carrying capacity: 26 A

---

## Insertion bridge

Insertion bridge - EB 10- DIK BU - 2716680

<https://www.phoenixcontact.com/pc/products/2716680>

Insertion bridge, pitch: 6.15 mm, color: blue



 Max. current carrying capacity: 26 A

# Solid-state relay terminal block - DEK-OV- 5DC/ 24DC/ 10

2961752

<https://www.phoenixcontact.com/pc/products/2961752>

## Insertion bridge

Insertion bridge - EB 80- DIK BU - 2715940

<https://www.phoenixcontact.com/pc/products/2715940>



Insertion bridge, pitch: 6.2 mm, color: blue

 Max. current carrying capacity: 26 A

---

## Insertion bridge

Insertion bridge - EB 80- DIK RD - 2715953

<https://www.phoenixcontact.com/pc/products/2715953>



Insertion bridge, pitch: 6.2 mm, color: red

 Max. current carrying capacity: 26 A

# Solid-state relay terminal block - DEK-OV- 5DC/ 24DC/ 10

2961752

<https://www.phoenixcontact.com/pc/products/2961752>

## Insertion bridge

Insertion bridge - EB 80- DIK WH - 2715788

<https://www.phoenixcontact.com/pc/products/2715788>



Insertion bridge, pitch: 6.15 mm, color: white

 Max. current carrying capacity: 26 A

---

## Separating plate

Separating plate - D-DEK 1,5 GN - 2716949

<https://www.phoenixcontact.com/pc/products/2716949>



Cover for setting the end of a terminal row, color: green

# Solid-state relay terminal block - DEK-OV- 5DC/ 24DC/ 10

2961752

<https://www.phoenixcontact.com/pc/products/2961752>

## Sensor/actuator terminal block

Sensor/actuator terminal block - DIKD 1,5 - 2715979

<https://www.phoenixcontact.com/pc/products/2715979>



Sensor/actuator terminal block, nom. voltage: 250 V, nominal current: 24 A, connection method: Screw connection, 1st, 2nd and 3rd level, Rated cross section: 2.5 mm<sup>2</sup>, cross section: 0.2 mm<sup>2</sup> - 4 mm<sup>2</sup>, mounting type: NS 35/7,5, NS 35/15, color: gray

---

## Zack marker strip

Zack marker strip - ZB 6:UNBEDRUCKT - 1051003

<https://www.phoenixcontact.com/pc/products/1051003>



Zack marker strip, Strip, white, unlabeled, can be labeled with: PLOTMARK, CMS-P1-PLOTTER, mounting type: snapped, for terminal block width: 6.2 mm, lettering field size: 6.15 x 10.5 mm, Number of individual labels: 10

# Solid-state relay terminal block - DEK-OV- 5DC/ 24DC/ 10



2961752

<https://www.phoenixcontact.com/pc/products/2961752>

## Zack marker strip

Zack marker strip - ZB 6,LGS:FORTL.ZAHLEN - 1051016

<https://www.phoenixcontact.com/pc/products/1051016>



Zack marker strip, Strip, white, labeled, can be labeled with: CMS-P1-PLOTTER, printed horizontally: consecutive numbers 1 ... 10, 11 ... 20, etc. up to 491 ... 500, mounting type: snapped, for terminal block width: 6.2 mm, lettering field size: 6.15 x 10.5 mm, Number of individual labels: 10

---

## Zack marker strip

Zack marker strip - ZB 6/WH-100:UNBEDRUCKT - 5060935

<https://www.phoenixcontact.com/pc/products/5060935>



Zack marker strip, Strip, white, unlabeled, can be labeled with: PLOTMARK, CMS-P1-PLOTTER, mounting type: snapped, for terminal block width: 6.2 mm, lettering field size: 6.15 x 10.5 mm, Number of individual labels: 1000

---

Phoenix Contact 2023 © - all rights reserved  
<https://www.phoenixcontact.com>

PHOENIX CONTACT GmbH & Co. KG  
Flachsmarktstraße 8  
D-32825 Blomberg  
+49 (0) 5235-3 00  
[info@phoenixcontact.com](mailto:info@phoenixcontact.com)