

## Data Sheet | Item Number: 231-312/037-000

1-conductor female connector; CAGE CLAMP®; 2.5 mm<sup>2</sup>; Pin spacing 5.08 mm; 12-pole; Lateral locking levers; 2,50 mm<sup>2</sup>; orange

<https://www.wago.com/231-312/037-000>



Color: ■ orange

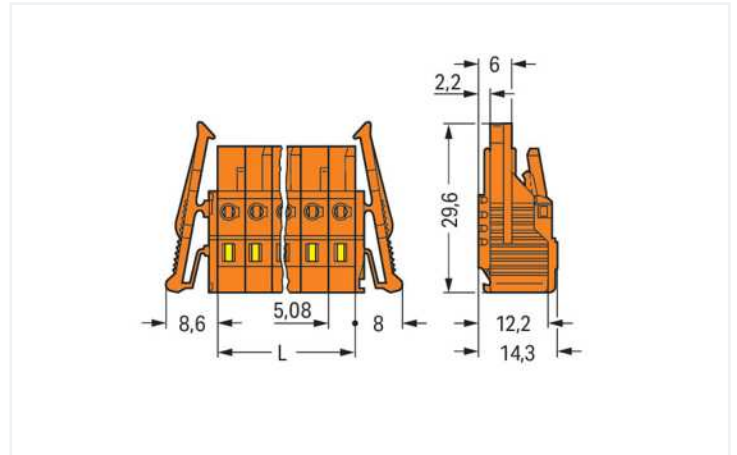

Dimensions in mm

L = pole no. x pin spacing

2- to 3-pole female connectors – one latch only

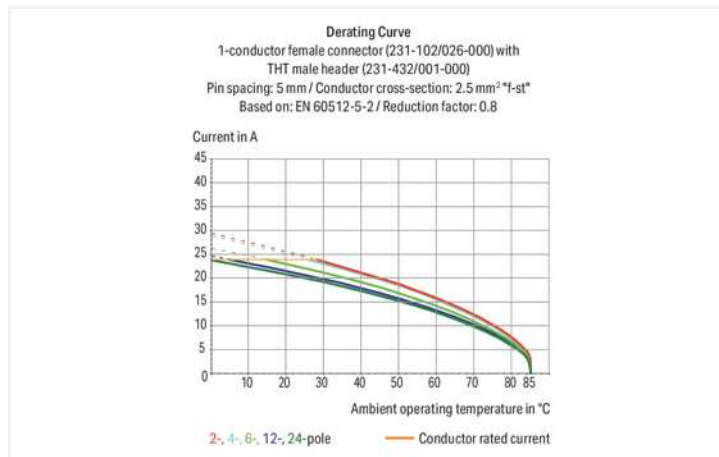

- Universal connection for all conductor types
- Easy cable pre-assembly and on-unit wiring via vertical and horizontal CAGE CLAMP® actuation
- Integrated test ports
- With coding fingers

### Notes

Safety information

The MCS – MULTI CONNECTION SYSTEM includes connectors without breaking capacity in accordance with DIN EN 61984. When used as intended, these connectors must not be connected/disconnected when live or under load. When used as intended, these connectors must not be connected/disconnected when live or under load. The circuit design should ensure header pins, which can be touched, are not live when unmated.

Variants:

Gold-plated or partially gold-plated contact surfaces

Other versions (or variants) can be requested from WAGO Sales or configured at <https://configurator.wago.com/>.

### Electrical data

Ratings per	IEC/EN 60664-1		
Overvoltage category	III	III	II
Pollution degree	3	2	2
Nominal voltage	320 V	320 V	630 V
Rated surge voltage	4 kV	4 kV	4 kV
Rated current	16 A	16 A	16 A

Approvals per	UL 1059		
Use group	B	C	D
Rated voltage	300 V	-	300 V
Rated current	15 A	-	10 A

Approvals per	UL 1977
Rated voltage	600 V
Rated current	15 A

Approvals per	CSA		
Use group	B	C	D
Rated voltage	300 V	-	300 V
Rated current	15 A	-	10 A

### Connection data

Connection points	12
Total number of potentials	12
Number of connection types	1
Number of levels	1

### Connection 1

Connection technology	CAGE CLAMP®
Actuation type	Operating tool
Actuation direction 1	Operation parallel to conductor entry
Actuation direction 2	Operation perpendicular to conductor entry
Solid conductor	0.08 ... 2.5 mm <sup>2</sup> / 28 ... 12 AWG
Fine-stranded conductor	0.08 ... 2.5 mm <sup>2</sup> / 28 ... 12 AWG
Fine-stranded conductor; with insulated ferrule	0.25 ... 1.5 mm <sup>2</sup>
Fine-stranded conductor; with uninsulated ferrule	0.25 ... 2.5 mm <sup>2</sup>
Strip length	8 ... 9 mm / 0.31 ... 0.35 inches
Pole number	12
Conductor entry direction to mating direction	0°

### Physical data

Pin spacing	5.08 mm / 0.2 inches
Width	77.56 mm / 3.054 inches
Height	14.3 mm / 0.563 inches
Depth	29.6 mm / 1.165 inches

### Mechanical data

Variable coding	Yes
Anti-rotation protection	Yes

### Plug-in connection

Contact type (pluggable connector)	Female connector/socket
Connector (connection type)	for conductor
Mismatching protection	No
Locking of plug-in connection	Locking lever

### Material data

Note (material data)	<a href="https://www.wago.com/us/material-specifications" href="_blank">Information on material specifications can be found here</a>
Color	orange
Material group	I
Insulation material	Polyamide (PA66)
Flammability class per UL94	V0
Clamping spring material	Chrome-nickel spring steel (CrNi)
Contact material	Copper alloy
Contact plating	Tin
Fire load	0.351 MJ
Weight	23 g

### Environmental requirements

Limit temperature range	-60 ... +85 °C
Processing temperature	-35 ... +60 °C

### Commercial data

Product Group	3 (Multi Conn. System)
eCl@ss 10.0	27-44-03-09
eCl@ss 9.0	27-44-03-09
ETIM 8.0	EC002638
ETIM 7.0	EC002638
PU (SPU)	25 pcs
Packaging type	Box
Country of origin	DE
GTIN	4044918348614
Customs tariff number	85366990990

### Environmental Product Compliance

RoHS Compliance Status	Compliant, No Exemption
------------------------	-------------------------

### Approvals / Certificates

#### General approvals



Approval	Standard	Certificate Name
CB DEKRA Certification B.V.	EN 61984, IEC 61984	NL-39756/A1
CSA DEKRA Certification B.V.	C22.2	1466354
KEMA/KEUR DEKRA Certification B.V.	EN 61984	71-121453
UL UL International Germany GmbH	UL 1977	E45171
UR Underwriters Laboratories Inc.	UL 1059	E45172

#### Declarations of conformity and manufacturer's declarations



Approval	Standard	Certificate Name
Railway WAGO GmbH & Co. KG	-	Railway Ready

Approvals for marine applications



Approval	Standard	Certificate Name
ABS American Bureau of Ship- ping	-	19-HG1869876-PDA

Downloads

Environmental Product Compliance

Compliance Search
Environmental Product Compliance 231-312/037-000

Documentation

Additional Information			
Technical Section	03.04.2019	pdf 2010.85 KB	

CAD/CAE-Data

CAD data
2D/3D Models 231-312/037-000

CAE data
EPLAN Data Portal 231-312/037-000

ZUKEN Portal 231-312/037-000
---------------------------------

1 Compatible Products

1.1 System counterpart

1.1.1 Male connector/plug



**Item No.: 231-642**  
1-conductor male connector; CAGE  
CLAMP®; 2.5 mm²; Pin spacing 5.08 mm;  
12-pole; 2,50 mm²; orange

**Item No.: 231-542/001-000**  
THT male header; 1.0 x 1.0 mm solder pin;  
angled; Pin spacing 5.08 mm; 12-pole;  
orange

**Item No.: 231-342/001-000**  
THT male header; 1.0 x 1.0 mm solder pin;  
straight; Pin spacing 5.08 mm; 12-pole;  
orange

1.2 Optional Accessories

1.2.1 Cover

































1.2.1.1 Cover



**Item No.: 231-669**  
 Lockout caps; for covering unused clamping units; orange

1.2.2 Ferrule

1.2.2.1 Ferrule

 <b>Item No.: 216-301</b> Ferrule; Sleeve for 0.25 mm <sup>2</sup> / AWG 24; insulated; electro-tin plated; yellow	 <b>Item No.: 216-321</b> Ferrule; Sleeve for 0.25 mm <sup>2</sup> / AWG 24; insulated; electro-tin plated; yellow	 <b>Item No.: 216-151</b> Ferrule; Sleeve for 0.25 mm <sup>2</sup> / AWG 24; uninsulated; electro-tin plated	 <b>Item No.: 216-131</b> Ferrule; Sleeve for 0.25 mm <sup>2</sup> / AWG 24; uninsulated; electro-tin plated; silver-colored
 <b>Item No.: 216-302</b> Ferrule; Sleeve for 0.34 mm <sup>2</sup> / 22 AWG; insulated; electro-tin plated; light turquoise	 <b>Item No.: 216-322</b> Ferrule; Sleeve for 0.34 mm <sup>2</sup> / 22 AWG; insulated; electro-tin plated; light turquoise	 <b>Item No.: 216-132</b> Ferrule; Sleeve for 0.34 mm <sup>2</sup> / AWG 24; uninsulated; electro-tin plated	 <b>Item No.: 216-152</b> Ferrule; Sleeve for 0.34 mm <sup>2</sup> / AWG 24; uninsulated; electro-tin plated
 <b>Item No.: 216-241</b> Ferrule; Sleeve for 0.5 mm <sup>2</sup> / 20 AWG; insulated; electro-tin plated; electrolytic copper; gastight crimped; acc. to DIN 46228, Part 4/09.90; white	 <b>Item No.: 216-201</b> Ferrule; Sleeve for 0.5 mm <sup>2</sup> / 20 AWG; insulated; electro-tin plated; white	 <b>Item No.: 216-221</b> Ferrule; Sleeve for 0.5 mm <sup>2</sup> / 20 AWG; insulated; electro-tin plated; white	 <b>Item No.: 216-141</b> Ferrule; Sleeve for 0.5 mm <sup>2</sup> / 20 AWG; insulated; electro-tin plated; electrolytic copper; gastight crimped; acc. to DIN 46228, Part 1/08.92
 <b>Item No.: 216-101</b> Ferrule; Sleeve for 0.5 mm <sup>2</sup> / AWG 22; un-insulated; electro-tin plated; silver-colored	 <b>Item No.: 216-121</b> Ferrule; Sleeve for 0.5 mm <sup>2</sup> / AWG 22; un-insulated; electro-tin plated; silver-colored	 <b>Item No.: 216-242</b> Ferrule; Sleeve for 0.75 mm <sup>2</sup> / 18 AWG; insulated; electro-tin plated; electrolytic copper; gastight crimped; acc. to DIN 46228, Part 4/09.90; gray	 <b>Item No.: 216-262</b> Ferrule; Sleeve for 0.75 mm <sup>2</sup> / 18 AWG; insulated; electro-tin plated; electrolytic copper; gastight crimped; acc. to DIN 46228, Part 4/09.90; gray
 <b>Item No.: 216-202</b> Ferrule; Sleeve for 0.75 mm <sup>2</sup> / 18 AWG; insulated; electro-tin plated; gray	 <b>Item No.: 216-222</b> Ferrule; Sleeve for 0.75 mm <sup>2</sup> / 18 AWG; insulated; electro-tin plated; gray	 <b>Item No.: 216-142</b> Ferrule; Sleeve for 0.75 mm <sup>2</sup> / 18 AWG; un-insulated; electro-tin plated; electrolytic copper; gastight crimped; acc. to DIN 46228, Part 1/08.92	 <b>Item No.: 216-102</b> Ferrule; Sleeve for 0.75 mm <sup>2</sup> / AWG 20; un-insulated; electro-tin plated; silver-colored
 <b>Item No.: 216-122</b> Ferrule; Sleeve for 0.75 mm <sup>2</sup> / AWG 20; un-insulated; electro-tin plated; silver-colored	 <b>Item No.: 216-243</b> Ferrule; Sleeve for 1 mm <sup>2</sup> / AWG 18; insulated; electro-tin plated; electrolytic copper; gastight crimped; acc. to DIN 46228, Part 4/09.90; red	 <b>Item No.: 216-263</b> Ferrule; Sleeve for 1 mm <sup>2</sup> / AWG 18; insulated; electro-tin plated; electrolytic copper; gastight crimped; acc. to DIN 46228, Part 4/09.90; red	 <b>Item No.: 216-203</b> Ferrule; Sleeve for 1 mm <sup>2</sup> / AWG 18; insulated; electro-tin plated; red
 <b>Item No.: 216-223</b> Ferrule; Sleeve for 1 mm <sup>2</sup> / AWG 18; insulated; electro-tin plated; red	 <b>Item No.: 216-103</b> Ferrule; Sleeve for 1 mm <sup>2</sup> / AWG 18; un-insulated; electro-tin plated	 <b>Item No.: 216-143</b> Ferrule; Sleeve for 1 mm <sup>2</sup> / AWG 18; un-insulated; electro-tin plated; electrolytic copper; gastight crimped; acc. to DIN 46228, Part 1/08.92	 <b>Item No.: 216-123</b> Ferrule; Sleeve for 1 mm <sup>2</sup> / AWG 18; un-insulated; electro-tin plated; silver-colored
 <b>Item No.: 216-204</b> Ferrule; Sleeve for 1.5 mm <sup>2</sup> / AWG 16; insulated; electro-tin plated; black	 <b>Item No.: 216-224</b> Ferrule; Sleeve for 1.5 mm <sup>2</sup> / AWG 16; insulated; electro-tin plated; black	 <b>Item No.: 216-244</b> Ferrule; Sleeve for 1.5 mm <sup>2</sup> / AWG 16; insulated; electro-tin plated; electrolytic copper; gastight crimped; acc. to DIN 46228, Part 4/09.90; black	 <b>Item No.: 216-264</b> Ferrule; Sleeve for 1.5 mm <sup>2</sup> / AWG 16; insulated; electro-tin plated; electrolytic copper; gastight crimped; acc. to DIN 46228, Part 4/09.90; black

1.2.2.1 Ferrule



**Item No.: 216-284**  
 Ferrule; Sleeve for 1.5 mm<sup>2</sup> / AWG 16; insulated; electro-tin plated; electrolytic copper; gastight crimped; acc. to DIN 46228, Part 4/09.90; black

**Item No.: 216-124**  
 Ferrule; Sleeve for 1.5 mm<sup>2</sup> / AWG 16; un-insulated; electro-tin plated

**Item No.: 216-144**  
 Ferrule; Sleeve for 1.5 mm<sup>2</sup> / AWG 16; un-insulated; electro-tin plated; electrolytic copper; gastight crimped; acc. to DIN 46228, Part 1/08.92; silver-colored

**Item No.: 216-104**  
 Ferrule; Sleeve for 1.5 mm<sup>2</sup> / AWG 16; un-insulated; electro-tin plated; silver-colored



**Item No.: 216-106**  
 Ferrule; Sleeve for 2.5 mm<sup>2</sup> / AWG 14; un-insulated; electro-tin plated; silver-colored

1.2.3 Insulation stop

1.2.3.1 Insulation stop



**Item No.: 231-670**  
 Insulation stop; 0.08-0.2 mm<sup>2</sup> / 0.2 mm<sup>2</sup> "s"; white

**Item No.: 231-671**  
 Insulation stop; 0.25 - 0.5 mm<sup>2</sup>; light gray

**Item No.: 231-672**  
 Insulation stop; 0.75 - 1 mm<sup>2</sup>; dark gray

1.2.4 Jumper

1.2.4.1 Jumper



**Item No.: 231-910**  
 Jumper; for conductor entry; 10-way; insulated; gray

**Item No.: 231-902**  
 Jumper; for conductor entry; 2-way; insulated; gray

**Item No.: 231-903**  
 Jumper; for conductor entry; 3-way; insulated; gray

**Item No.: 231-905**  
 Jumper; for conductor entry; 5-way; insulated; gray



**Item No.: 231-907**  
 Jumper; for conductor entry; 7-way; insulated; gray

1.2.5 Marking

1.2.5.1 Marking strip



**Item No.: 210-331/508-103**  
 Marking strips; as a DIN A4 sheet; MARKED; 1-12 (200x); Height of marker strip: 2.3 mm/0.091 in; Strip length 182 mm; Horizontal marking; Self-adhesive; white

**Item No.: 210-332/508-202**  
 Marking strips; as a DIN A4 sheet; MARKED; 1-16 (160x); Height of marker strip: 3 mm; Strip length 182 mm; Horizontal marking; Self-adhesive; white

**Item No.: 210-332/508-205**  
 Marking strips; as a DIN A4 sheet; MARKED; 1-32 (80x); Height of marker strip: 3 mm; Strip length 182 mm; Horizontal marking; Self-adhesive; white

**Item No.: 210-331/508-104**  
 Marking strips; as a DIN A4 sheet; MARKED; 13-24 (200x); Height of marker strip: 2.3 mm/0.091 in; Strip length 182 mm; Horizontal marking; Self-adhesive; white



**Item No.: 210-332/508-204**  
 Marking strips; as a DIN A4 sheet; MARKED; 17-32 (160x); Height of marker strip: 3 mm; Strip length 182 mm; Horizontal marking; Self-adhesive; white

**Item No.: 210-332/508-206**  
 Marking strips; as a DIN A4 sheet; MARKED; 33-48 (160x); Height of marker strip: 3 mm; Strip length 182 mm; Horizontal marking; Self-adhesive; white

1.2.6 Strain relief

### 1.2.6.1 Strain relief housing



**Item No.: 232-642**

Strain relief housing; for female and male connectors; 2 parts; Pin spacing 5.08 mm; 12-pole; orange

### 1.2.7 Test and measurement

#### 1.2.7.1 Testing accessories



**Item No.: 210-136**

Test plug; 2 mm Ø; with 500 mm cable; red



**Item No.: 231-661**

Test plugs for female connectors; for 5 mm and 5.08 mm pin spacing; 2,50 mm<sup>2</sup>; light gray

### 1.2.8 Tool

#### 1.2.8.1 Operating tool



**Item No.: 231-231**

Combination operating tool; red



**Item No.: 209-132**

Operating tool; for connecting comb-style jumper bar; made of insulating material; 2-way; natural



**Item No.: 280-440**

Operating tool; made of insulating material; 10-way



**Item No.: 209-130**

Operating tool; made of insulating material; 1-way; for 264 Series (1-/2-way), 280, 281 Series (up to 3-way); natural



**Item No.: 231-291**

Operating tool; made of insulating material; 1-way; loose; red



**Item No.: 231-131**

Operating tool; made of insulating material; 1-way; loose; white



**Item No.: 280-432**

Operating tool; made of insulating material; 2-way; white



**Item No.: 280-433**

Operating tool; made of insulating material; 3-way



**Item No.: 280-434**

Operating tool; made of insulating material; 4-way



**Item No.: 280-435**

Operating tool; made of insulating material; 5-way; gray



**Item No.: 280-436**

Operating tool; made of insulating material; 6-way



**Item No.: 280-437**

Operating tool; made of insulating material; 7-way



**Item No.: 280-438**

Operating tool; made of insulating material; 8-way



**Item No.: 231-159**

Operating tool; natural

### Installation Notes

#### Conductor termination



Inserting a conductor via 3.5 mm screwdriver – CAGE CLAMP® actuation parallel to conductor entry.



Inserting a conductor via 3.5 mm screwdriver – CAGE CLAMP® actuation perpendicular to conductor entry.



Inserting a conductor into CAGE CLAMP® unit via operating tool (231-291).



Inserting a conductor via operating tool.

## Coding



Coding a female connector by removing coding finger(s).

## Testing



Testing – female connector with CAGE CLAMP®  
Integrated test ports for testing perpendicular to conductor entry via 2 or 2.3 mm Ø test plug

## Installation



Male connector with strain relief plate



Strain relief housing shown with a male connector equipped with CAGE CLAMP®

## Marking



Labeling via direct marking or self-adhesive strips.