

RCM570AC4

Weidmüller Interfaces GmbH & Co. KG

Postfach 3030

32760 Detmold

Tel. +49 5231 14-0

Fax. +49 5231 14-2083

info@weidmueller.com

www.weidmueller.com

Product image



Similar to illustration

Individual relays within the RIDERSERIES RCM

- 4 CO contacts
- DC coils
- With integrated status LED, free-wheeling diode and test button

General ordering data

Version	RIDERSERIES RCM, Relay, Number of contacts: 4, CO contact AgNi, Rated control voltage: 24 V DC, Continuous current: 6 A, Plug-in connection, Test button available: Yes
Order No.	8957170000
Type	RCM570AC4
GTIN (EAN)	4032248755448
Qty.	10 pc(s).

RCM570AC4

Weidmüller Interfaces GmbH & Co. KG

Postfach 3030

32760 Detmold

Tel. +49 5231 14-0

Fax. +49 5231 14-2083

info@weidmueller.com

www.weidmueller.com

Technical data

Dimensions and weights

Depth	29 mm	Depth (inches)	1.142 inch
Height	28 mm	Height (inches)	1.102 inch
Width	22.5 mm	Width (inches)	0.886 inch
Net weight	28.5 g		

Temperatures

Storage temperature	-40 °C...85 °C	Operating temperature	-40 °C...70 °C
Humidity	40 °C / 93 % rel. humidity, no condensation		

Rated data UL

Certificate No. (cURus)	E224238
-------------------------	---------

Control side

Rated control voltage	24 V DC	Rated current DC	31.6 mA
Power rating	759 mW	Pull-in/drop-out voltage, typ.	18 V / 2.4 V DC
Coil resistance	777 Ω ± 10 %	Coil tolerance	10 %
Status indicator	Green LED	Protective circuit	Free-wheeling diode

Load side

Rated switching voltage	240 V AC	Continuous current	6 A
Max. switching frequency at rated load	0.1 Hz	Inrush current	12 A / 20 ms
AC switching capacity (resistive), max.	1500 VA	DC switching capacity (resistive), max.	144 W @ 24 V
Switch-on delay	≤ 15 ms	Switch-off delay	< 20 ms
Contact type	4 CO contact (AgNi)	Mechanical service life	AC coil 20 x 10 ⁶ switching cycles, DC coil 30 x 10 ⁶ switching cycles
Min. switching power	1 mA @ 24 V, 10 mA @ 12 V, 100 mA @ 5 V		

General data

Test button available	Yes	Version of test button	lockable
Mechanical switch position indicator	Yes	Colour	Transparent
UL 94 flammability rating	V-2		

Insulation coordination

Rated voltage	250 V	Pollution severity	2
Surge voltage category	III	Insulating material group	IIIa
Clearance and creepage distances for control side - load side	≥ 4 mm	Dielectric strength for control side - load side	2.5 kV _{eff} / 1 Min.
Dielectric strength of neighbouring contacts	2 kV _{eff} / 1 min	Dielectric strength of open contact	1.2 kV _{eff} / 1 min.
Impulse withstand voltage	5 kV (1.2/50 μs)	Protection degree	IP20

Further details of approvals / standards

Standards	IEC 61810-1, UL508	Certificate No. (CSA)	249409-2426937
Certificate No. (VDE)	40011762	Certificate No. (cURus)	E224238

Creation date June 1, 2022 10:03:16 AM CEST

Catalogue status 20.05.2022 / We reserve the right to make technical changes.

RCM570AC4

Weidmüller Interfaces GmbH & Co. KG

Postfach 3030

32760 Detmold

Tel. +49 5231 14-0

Fax. +49 5231 14-2083

info@weidmueller.com

www.weidmueller.com

Technical data**Connection data**

Wire connection method Plug-in connection

Classifications

ETIM 6.0	EC001437	ETIM 7.0	EC001437
ETIM 8.0	EC001437	ECLASS 9.0	27-37-16-01
ECLASS 9.1	27-37-16-01	ECLASS 10.0	27-37-16-01
ECLASS 11.0	27-37-16-01	ECLASS 12.0	27-37-16-01

Approvals

Approvals



ROHS	Conform
UL File Number Search	E224238

Downloads

Approval/Certificate/Document of Conformity	EU Konformitätserklärung / EU Declaration of Conformity
Engineering Data	CAD data – STEP
Engineering Data	EPLAN, WSCAD
Catalogues	Catalogues in PDF-format
Brochures	

Drawings

Wiring diagram

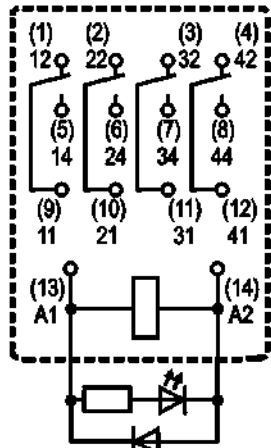

View of Pins from below

Graph

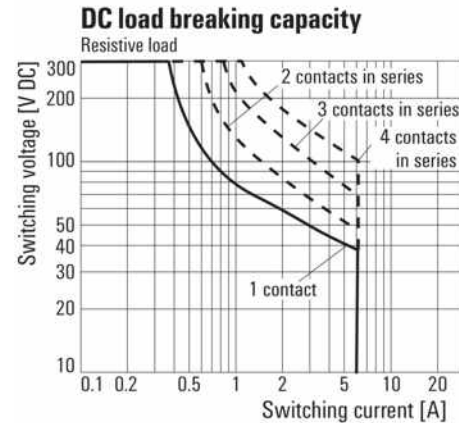

DC load limit curve
Resistive load

Graph

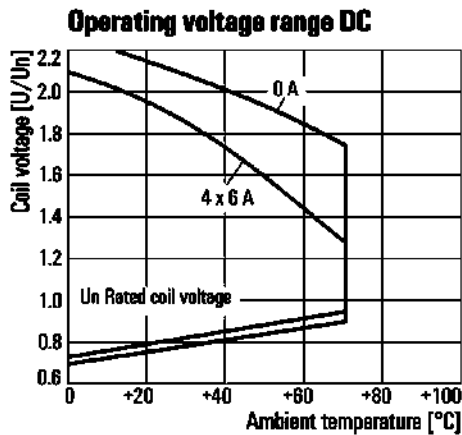

DC operational voltage range

Graph

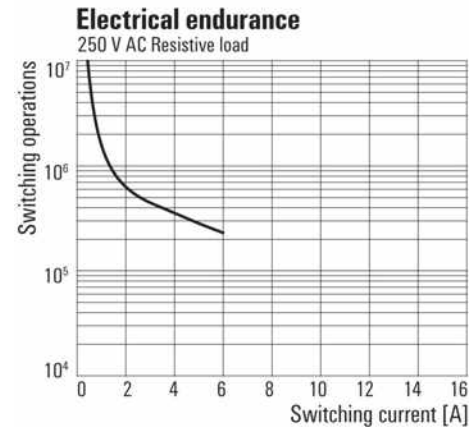

Electrical service life
250 V AC resistive load

Graph

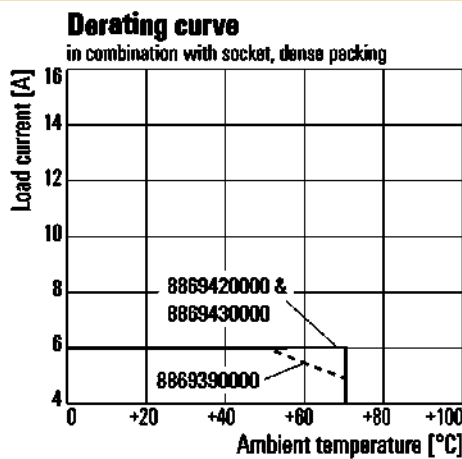

Derating curve
Relay in combination with base

Dimensional drawing

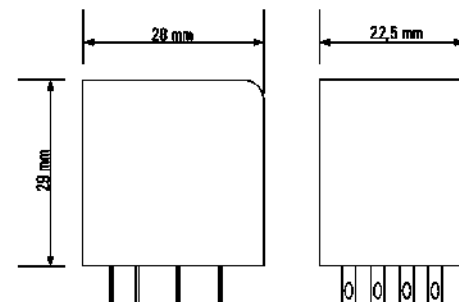

RCM570AC4

Weidmüller Interfaces GmbH & Co. KG

Postfach 3030

32760 Detmold

Tel. +49 5231 14-0

Fax. +49 5231 14-2083

info@weidmueller.com

www.weidmueller.com

Drawings

Miscellaneous

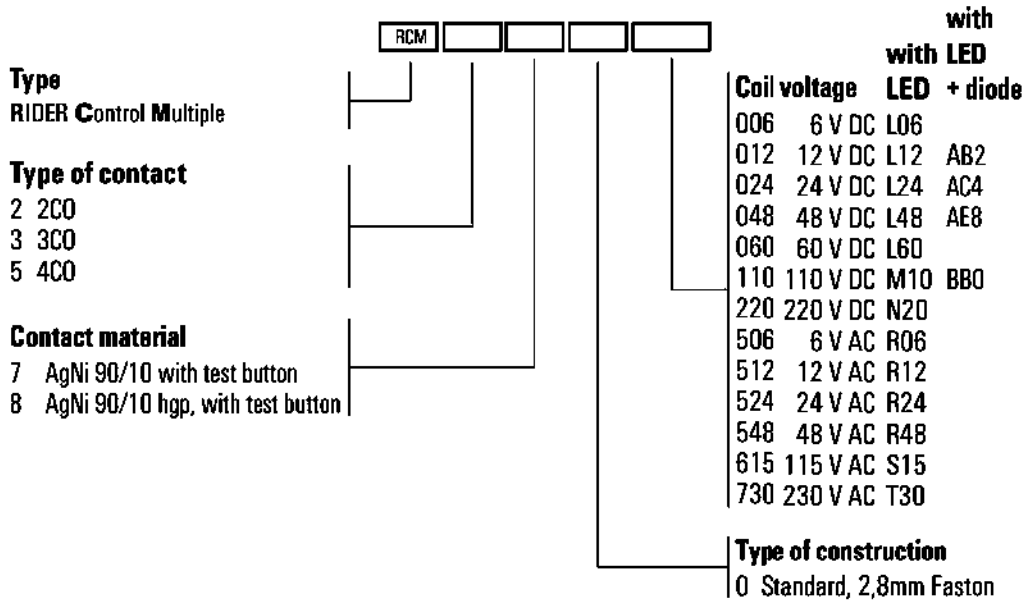

Type codes