

**JOHNSON<sup>®</sup>**

***SMA One Piece  
Semi-Rigid Connectors***

***Emerson Network Power  
Connectivity Solutions***



  
**EMERSON<sup>™</sup>**  
Network Power

**EMERSON. CONSIDER IT SOLVED.<sup>™</sup>**

## SMA Captivated Solderless Contact Connectors for Semi-Rigid Cable

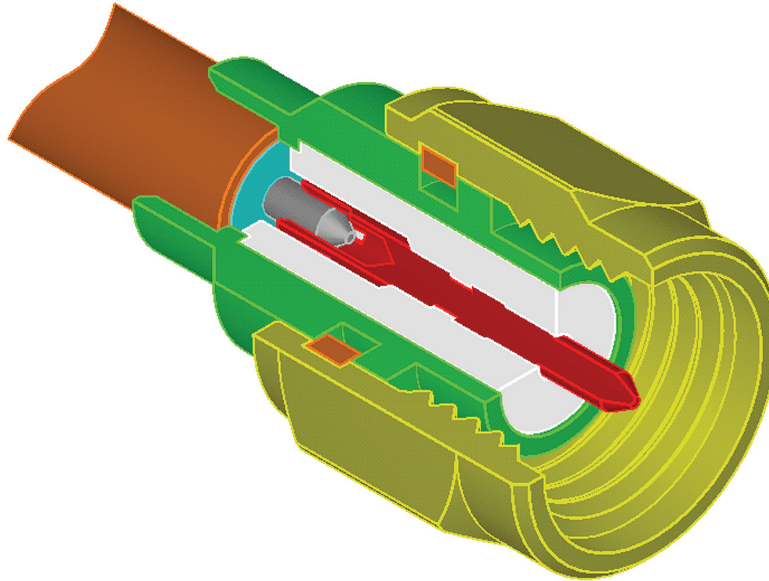

The Johnson® captivated solderless contact connectors for semi-rigid cable provide a unique solution for high frequency cable assemblers. As compared to standard solder-on connectors with separate center contacts, these SMA connectors offer several key advantages:

- Assembly is easier and faster than non-captive contact connectors.
- Captivated center contacts allow the complete connector assembly to simply plug onto the prepared cable. The only soldering required is between the connector body and cable jacket.
- Rugged center contact socket design reduces potential intermittent signals, which can be caused by the use of high temperature lead free solder alloys.
- Precision center contacts provide predictable mechanical and electrical performance. Factory controlled contact location reduces variations in high frequency electrical performance.
- Electrical performance is similar to non-captive contact connectors.
- Low VSWR is specified to 18 GHz. The connectors can be used at higher frequencies with very good Return Loss.
- Plug connectors feature durable thickwall style mating interfaces with extended cutoff frequency to 28 GHz.
- Bulkhead jack connectors are provided with silicone rubber o-rings for environmental sealing of the flange mounting surface.
- Precision hand assembly tooling assures repeatable performance.
- All connectors meet or exceed the performance requirements of MIL-PRF-39012 captive contact semi-rigid SMA connectors.

### MATERIAL SPECIFICATIONS

**Bodies:** Brass per QQ-B-626, gold plated\* per MIL-G-45204 .00001" min. or nickel plated per QQ-N-290

**Contacts:** Beryllium copper per QQ-C-530, gold plated per MIL-G-45204 .00005" min.

**Nut Retention Spring:** Beryllium copper per QQ-C-533. Unplated

**Insulators:** PTFE fluorocarbon per ASTM D 1710 and ASTM D 1457

**Mounting Hardware:** Brass per QQ-B-626 or QQ-B-613, gold plated per MIL-G-45204 .00001" min. or nickel plated per QQ-N-290

**Seal Rings:** Silicone rubber per ZZ-R-765

\* All gold plated parts include a .00005" min. nickel underplate barrier layer.

### MECHANICAL SPECIFICATIONS

**Engagement Design:** MIL-STD-348, Series SMA

**Durability:** 500 Cycles minimum

**Engagement/Disengagement Force:** 2 inch-pounds maximum

**Mating Torque:** 7 to 10 inch-pounds

**Bulkhead Mounting Nut Torque:** 15 inch-pounds maximum

**Coupling Proof Torque:** 15 inch-pounds minimum

**Coupling Nut Retention:** 60 pounds minimum

**Contact Retention:** 6 pounds minimum axial force

Cable Retention:	Axial Force (lbs)	Torque (in-oz)
Connectors for .086 semi-rigid	30	16
Connectors for .141 semi-rigid	60	55

### ENVIRONMENTAL SPECIFICATIONS

(Meets or Exceeds the Applicable Paragraph of MIL-PRF-39012)

**Temperature Range:** -65°C to +165°C

**Thermal Shock:** MIL-STD-202, Method 107, Condition B - Except 115°C High Temp

**Corrosion:** MIL-STD-202, Method 101, Condition B

**Shock:** MIL-STD-202, Method 213, Condition I

**Vibration:** MIL-STD-202, Method 204, Condition D

**Moisture Resistance:** MIL-STD-202, Method 106

+ Avoid applications where hazardous voltages are applied to user contacted components.

Voltage ratings relate to reliable component operation, not safe application.

### Mating Engagement for SMA Series per MIL-STD-348

MATING ENGAGEMENT FOR SMA SERIES THICKWALL PLUG COMPATIBLE WITH MIL-C-39012

1. ID TO MEET VSWR, CONTACT RESISTANCE AND INSERTION WITHDRAWAL FORCES WHEN MATED WITH A DIA .0355-.0370 PIN.

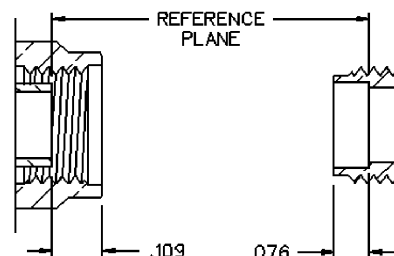
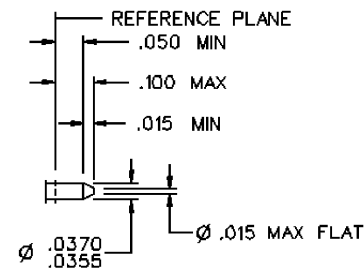
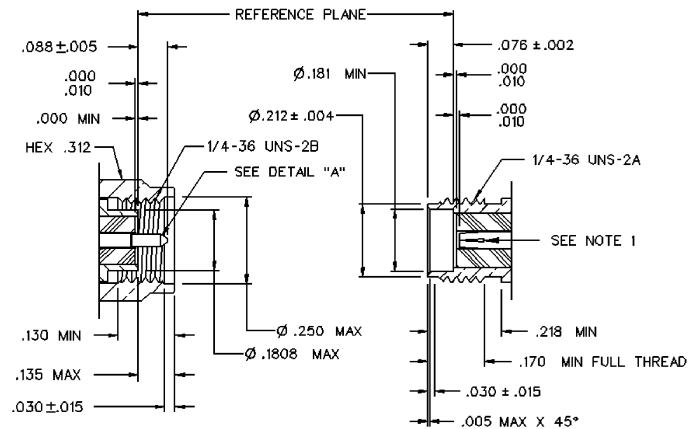

# SMA - 50 Ohm Connectors

For Semi-Rigid Cable



## ELECTRICAL SPECIFICATIONS

Impedance: 50 Ohms

Frequency Range:

Plugs .....	0-28 GHz
Jacks .....	0-25 GHz

VSWR: (f = GHz)

Plugs for Cable Type	0-18 GHz	18-28 GHz
.086 semi-rigid .....	1.07+.01f	<1.30 Typical
.141 semi-rigid .....	1.05+.01f	<1.25 Typical

Jacks for Cable Type	0-18 GHz	18-25 GHz
.086 semi-rigid .....	1.07+.01f	<1.30 Typical
.141 semi-rigid .....	1.05+.01f	<1.25 Typical

Working Voltage: (Vrms maximum)

Connectors for Cable Type	Sea Level	70K Feet
.086 semi-rigid .....	335	85
.141 semi-rigid .....	.500	125

Dielectric Withstanding Voltage: (Vrms minimum at sea level)

Connectors for Cable Type	
.086 semi-rigid .....	1000
.141 semi-rigid .....	1500

Corona Level: (Volts minimum at 70,000 feet)

Connectors for Cable Type	
.086 semi-rigid .....	250
.141 semi-rigid .....	375

Insertion Loss:  $0.03 \sqrt{f(\text{GHz})}$ , dB maximum, tested at 10 GHz

Insulation Resistance: 5000 Megohms minimum

Contact Resistance: (milliohms maximum)	Initial	After Environmental
Center Contact .....	3.0	5.0
Outer Conductor .....	2.0	Not Applicable

RF Leakage: (dB minimum, tested at 2.5 GHz) .....-90

RF High Potential Withstanding Voltage:

(Vrms minimum, tested at 4 and 7 MHz)

Connectors for Cable Type	
.086 semi-rigid .....	.670
.141 semi-rigid .....	1000

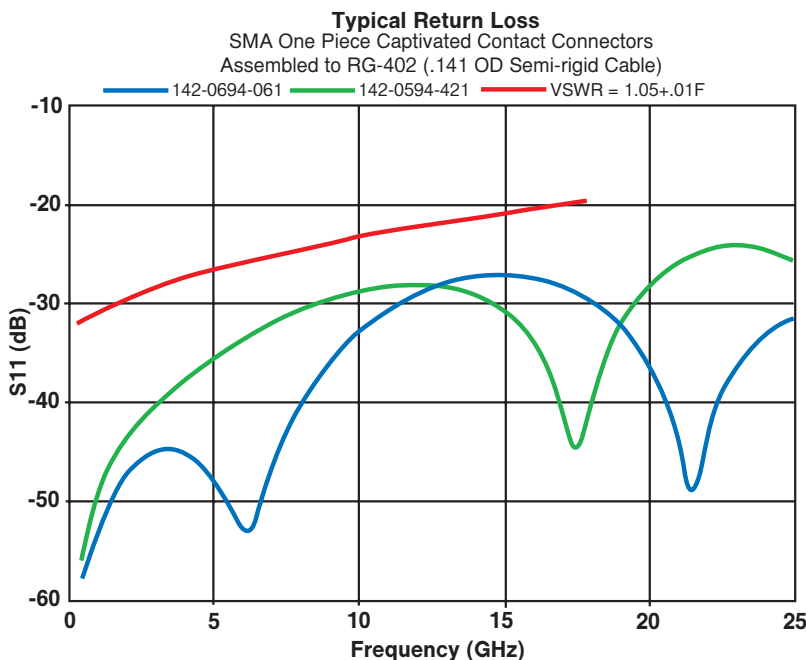

## Straight Solder Type Plug With Captivated Solderless Contact, Captive Nut and Thick Wall Interface

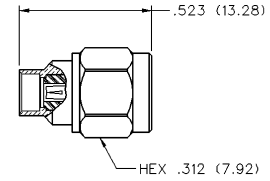
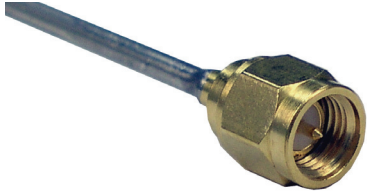

CABLE TYPE	VSWR & FREQ. RANGE	GOLD PLATED	NICKEL PLATED
.086 Semi-Rigid	0-18 GHz: 1.07 + .01f (GHz) 18-28 GHz: <1.30 Typical	142-0693-061	142-0693-066
.141 Semi-Rigid	0-18 GHz: 1.05 + .01f (GHz) 18-28 GHz: <1.25 Typical	142-0694-061	142-0694-066

Assembly instructions on back page.

## Straight Solder Type Bulkhead Jack With Captivated Solderless Contact and O-Ring

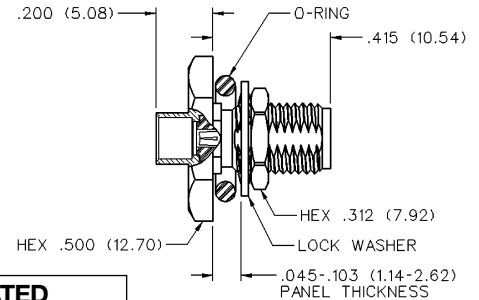
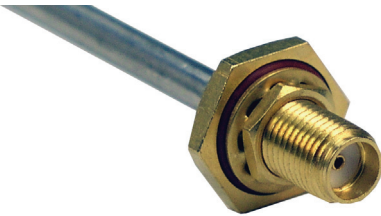

CABLE TYPE	VSWR & FREQ. RANGE	GOLD PLATED	NICKEL PLATED
.086 Semi-Rigid	0-18 GHz: 1.07 + .01f (GHz) 18-25 GHz: <1.30 Typical	142-0593-421	142-0593-426
.141 Semi-Rigid	0-18 GHz: 1.05 + .01f (GHz) 18-25 GHz: <1.25 Typical	142-0594-421	142-0594-426

Assembly instructions and mounting hole layout on back page.

## Straight Solder Type Bulkhead Jack With Captivated Solderless Contact and O-Ring

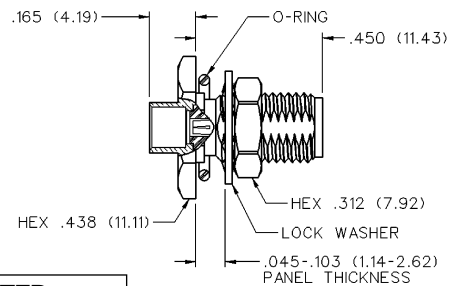
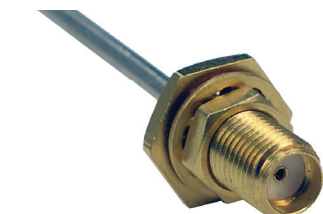

CABLE TYPE	VSWR & FREQ. RANGE	GOLD PLATED	NICKEL PLATED
.086 Semi-Rigid	0-18 GHz: 1.07 + .01f (GHz) 18-25 GHz: <1.30 Typical	142-0593-431	142-0593-436
.141 Semi-Rigid	0-18 GHz: 1.05 + .01f (GHz) 18-25 GHz: <1.25 Typical	142-0594-431	142-0594-436

Assembly instructions and mounting hole layout on back page.



# SMA - 50 Ohm Connectors

For Semi-Rigid Cable

## Semi-Rigid Assembly Tools

Accurate assembly of the Semi-Rigid Cabled Connectors is obtained with the tools listed below. Industry standard devices are used if possible for customer convenience and tool compatibility.

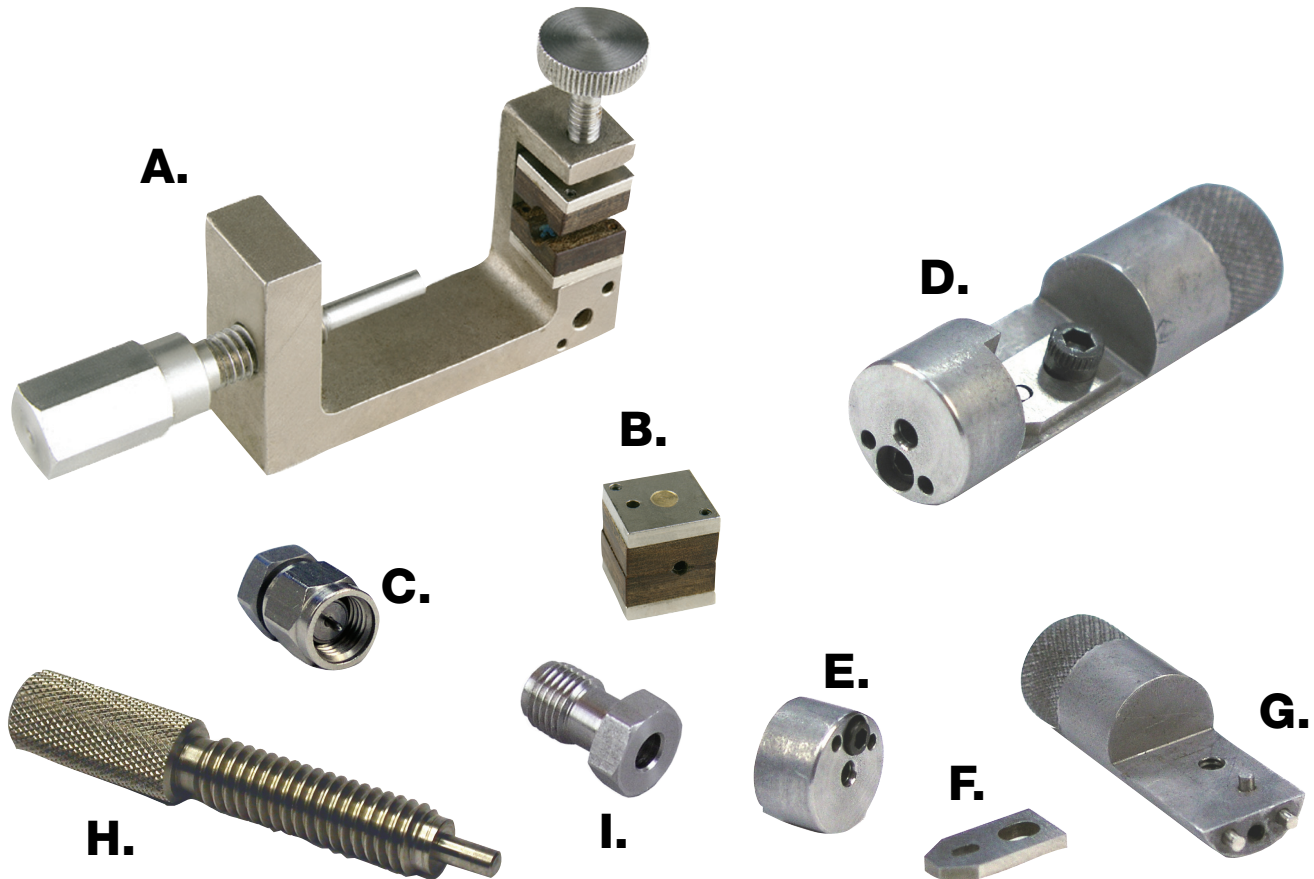

ITEM	PART NUMBER	DESCRIPTION
A	140-0000-962	Soldering Vise (does not include inserts (B) or stop screw (H) )
B	140-0000-964	Semi-Rigid Cable Clamp Inserts for .086" OD Cable
	140-0000-965	Semi-Rigid Cable Clamp Inserts for .141" OD Cable
C	140-0000-973	Soldering Mating Fixture for SMA Jack Connectors
D	140-0000-975	Complete Center Conductor Pointing Tool for .086" OD Cable
	140-0000-976	Complete Center Conductor Pointing Tool for .141" OD Cable
E	140-0000-977	Bushing for .086" OD Cable Conductor Pointing Tool
	140-0000-978	Bushing for .141" OD Cable Conductor Pointing Tool
F	140-0000-979	Blade for Center Conductor Pointing Tool
G	140-0000-980	Frame for Center Conductor Pointing Tool
H	140-0000-981	Stop Screw for Semi-Rigid Cable Soldering Vise
I	140-0000-982	Soldering Mating Fixture for SMA Plug Connectors

## ASSEMBLY INSTRUCTIONS

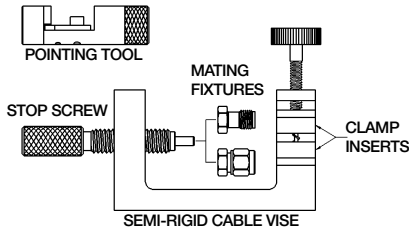

Identify the connector (plug or jack) and tools

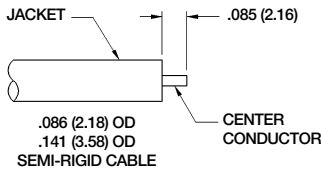

Strip the cable jacket and dielectric to dimension shown. Do not nick the center conductor.

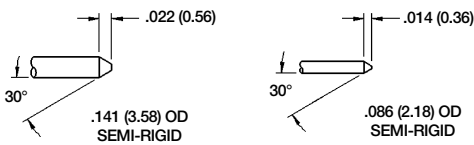

Bevel the entire diameter on the end of the cable center conductor until the point resembles the appropriate dimensional profile. This operation can be accomplished effectively by using the recommended center conductor pointing tool as described in step 4.

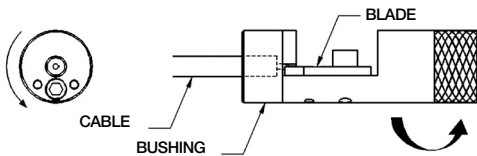

Insert the stripped cable into the bushing of the appropriate pointing tool until the center conductor just touches the blade. While maintaining light pressure on the center conductor against the blade, turn the tool in a counter-clockwise fashion as viewed from the bushing end of the tool. Continue cutting the center conductor point until the cable jacket bottoms out inside the bushing.

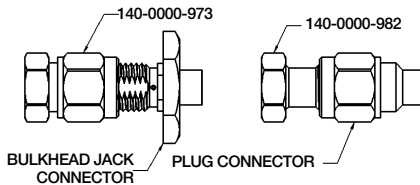

Attach the appropriate soldering mating fixture to the connector and tighten to a maximum of 8 inch pounds of torque.

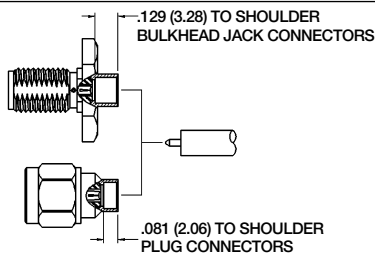

Clean all debris from the prepared cable and insert the cable into the connector, making sure that the cable jacket bottoms out against the internal shoulder of the connector body.

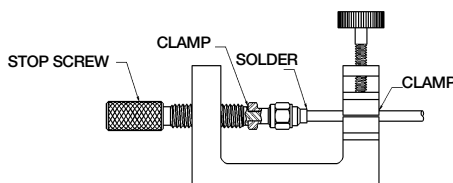

Insert the stop screw into the mating fixture. Clamp the cable and fixtured connector assembly securely in the soldering vise. Solder the connector body to the cable as shown, while insuring the cable dielectric expansion does not move the assembly. Allow the assembly to cool before removing the connector from the fixture

**Emerson Network Power Connectivity Solutions** is a global manufacturer of a broad line of connectivity products and services supporting wireline and wireless communications, data networking, test and measurement, military, medical, broadcast and industrial applications. Connectivity Solutions delivers custom-engineered products and solutions with best-in-class service and support and customer-focused offers such as quick-turn prototyping, samples and supply chain management.

#### **Telecom/Broadband/OEM Cable Assemblies**

Custom solutions for the Telecom, Data and Broadband markets. Expert in 50 position Telco cables, coax assemblies and analog filter products. Quick delivery capabilities. Custom solutions for Multiconductor, Flat Ribbon, Wire Harness, Coaxial, D-sub, SCSI and discrete assemblies. Design support, molding, polarizing, custom shielding and testing capabilities

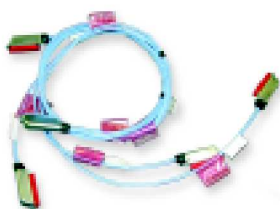

#### **Microwave Components**

High Performance components including Attenuators, Terminations, Couplers, DC Blocks, Power Dividers, Phase Shifters, Adapters and High Performance Low Loss RF cable Assemblies. Able to offer QPL qualified products. Standard components held in stock.



#### **CATV Components**

Residential and multi-unit amplifiers, security terminators, and drop splitters and passives. Headend signal management products and fiber optic connectivity for headend and optical node applications and return path test equipment



#### **Precision Coaxial Connectors and Cable Assemblies**

Subminiature, microminiature, miniature and standard connectors, and custom assemblies, including SMA, SMB, 40 GHz-capable SMK, MCX, MMCX, BNC and N Connectors. Custom designs and modifications of standard products.



#### **Multi-purpose Connectivity and Structured Wiring**

Commercial-grade connectors, including F Connectors, BNC and TNC. Structured wiring components, including CAT 5E/6 assemblies, patch panels, wallplates and tools for data communications installations. USB and Audio/Video cables, D-sub connectors, adapters and hardware.



#### **Fiber Optic Cable Assemblies and Components**

High performance multimode and single mode fiber patch cords, multi-fiber assemblies and attenuators. Solutions for the Storage Area Network and Enterprise computing markets and for ESCON™, optical FibreChannel, Infiniband and Parallel Optics applications.

