

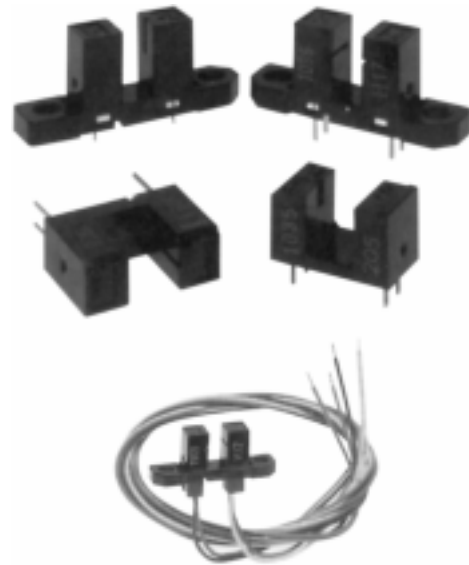





EE-SX1035/1081/1088(-W1)/1096(-W1)

Low-cost, PCB-mount with
Phototransistor Output

- LED and phototransistor assure long life and high reliability
- Non-contact, noiseless sensing, ideal for office automation and computer peripheral equipment
- Models available with either horizontal (EE-SX1096) or vertical (EE-SX1081/1088) aperture
- EE-SX1088(-W1) and EE-SX1096(-W1) wire harness versions provide easy, reliable solder-free connection



Ordering Information

Appearance	Sensing method	Slot width	Slot depth	Sensing object	Output configuration	Weight	Part number
	Transmissive	5.2 mm	5.4 mm	Opaque, 1.0 x 1.0 mm min.	Phototransistor	Approx. 1.3 g	EE-SX1035
		5.0 mm	7.5 mm	Opaque, 0.5 x 2.1 mm min.		Approx. 0.5 g	EE-SX1081
		3.4 mm	7.5 mm	Opaque, 2.1 x 0.5 mm min.		Approx. 0.6 g	EE-SX1088
				Opaque, 0.5 x 2.1 mm min.	Approx. 0.6 g	EE-SX1096	
				Opaque, 2.1 x 0.5 mm min.	Phototransistor with wire harness	Approx. 4.5 g	EE-SX1088-W1
				Opaque, 0.5 x 2.1 mm min.		Approx. 4.5 g	EE-SX1096-W1

Specifications

■ ABSOLUTE MAXIMUM RATINGS (T_A = 25°C (77°F))

Item		Symbol	Rated value
Emitter	Forward current	I _F	50 mA*
	Reverse voltage	V _R	4 V
Detector	Collector-emitter voltage	V _{CEO}	30 V
	Collector current	I _C	20 mA
	Collector dissipation	P _C	100 mW*
Ambient temperature	Operating	T _{opr}	-25°C to 85°C (-13°F to 185°F)
	Storage	T _{stg}	-30°C to 100°C (-22°F to 212°F)

*Refer to Engineering Data if the ambient temperature is not within the normal room temperature range.

■ CHARACTERISTICS (T_A = 25°C (77°F))

Item		Symbol	Value	Condition
Emitter	Forward voltage	V _F	1.2 V typ.; 1.5 V max.	I _F =30mA
	Reverse current	I _R	0.01 μA typ.; 10 μA max.	V _R =4 V
	Peak emission wavelength	λ _{p(L)}	940 nm	I _F =20 mA
Detector	Dark current	I _D	2 nA typ.; 200 nA max.	V _{CE} =10 V 0 lx
	Peak spectral sensitivity wavelength	λ _{p(P)}	850 nm typ.	V _{CE} =10 V
Combination	Light current (collector current)	I _L	0.5 to 14 mA	I _F =20 mA V _{CE} =10 V
	Collector-emitter saturated voltage	V _{CE (sat)}	0.1 V typ.; 0.4 V max.	I _F =20 mA I _L =0.1 mA
	Rising time*	t _r	4 μs typ.	V _{CC} =5 V I _L =5 mA
	Falling time*	t _f	4 μs typ.	R _L =100 Ω

*The following illustrations show the rising time, t_r, and the falling time, t_f.

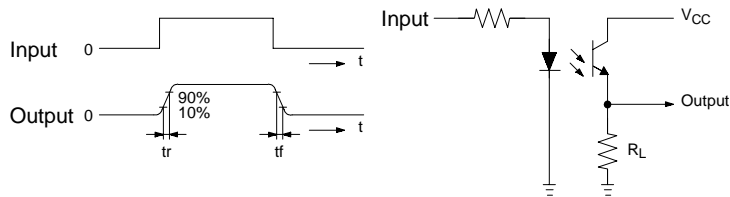

Engineering Data

Note: The operating conditions of the photomicrosensor must be within the absolute maximum rating ranges.

TEMPERATURE CHARACTERISTICS

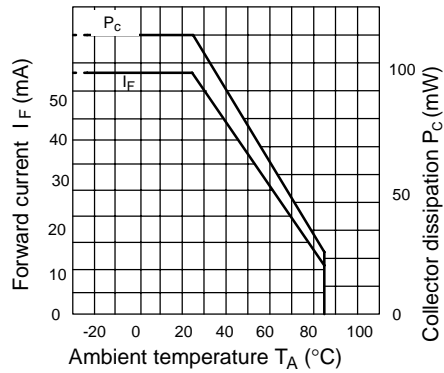

INPUT CHARACTERISTICS (TYPICAL)

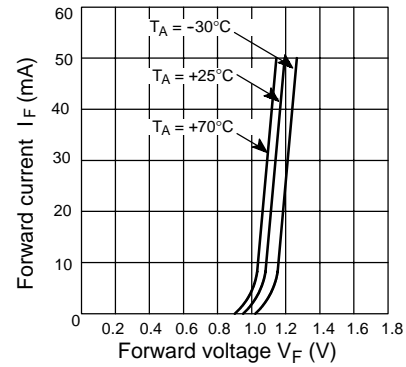

INPUT/OUTPUT CHARACTERISTICS (TYPICAL)

EE-SX1035

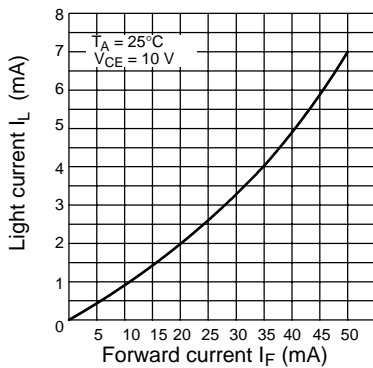

EE-SX1081

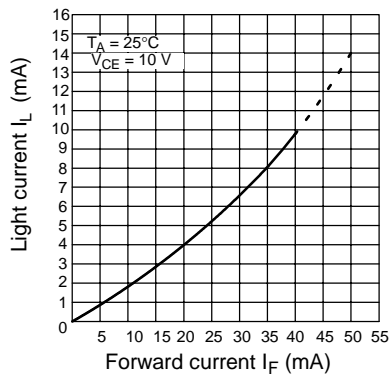

EE-SX1088/1096(-W1)

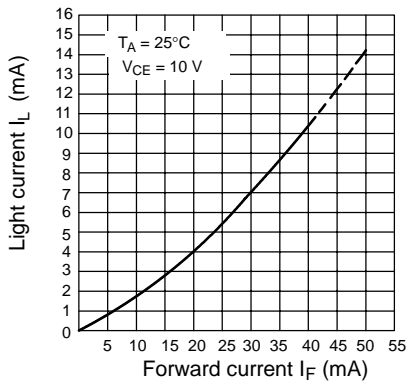

OUTPUT CHARACTERISTICS (TYPICAL)

EE-SX1035

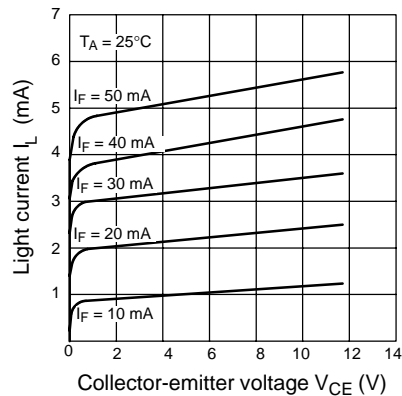

EE-SX1081/1088/1096(-W1)

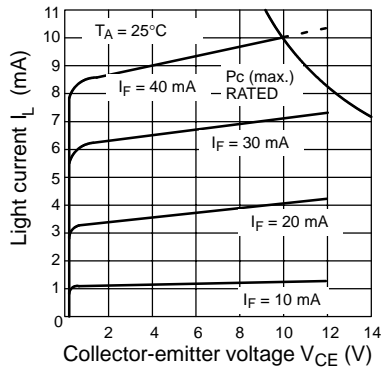

DARK CURRENT TEMPERATURE DEPENDENCY (TYPICAL)

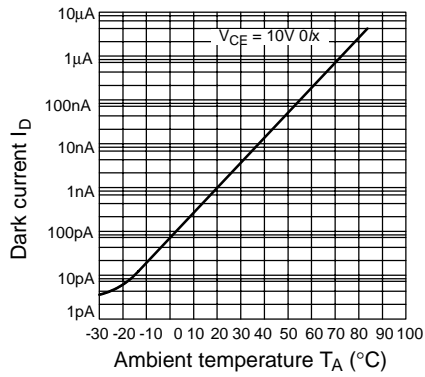

LIGHT CURRENT TEMPERATURE DEPENDENCY (TYPICAL)

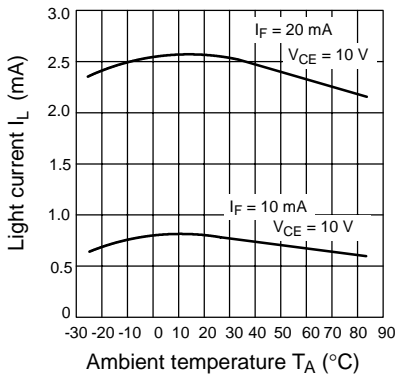

SENSING POSITION CHARACTERISTICS (TYPICAL)

EE-SX1035

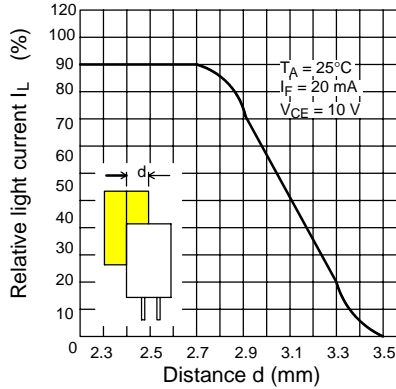

EE-SX1081

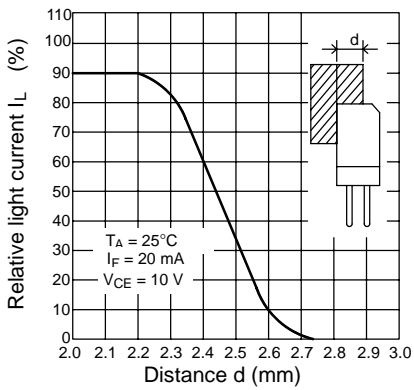

EE-SX1088(-W1)

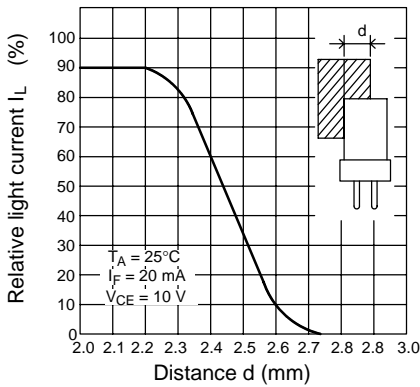

EE-SX1096(-W1)

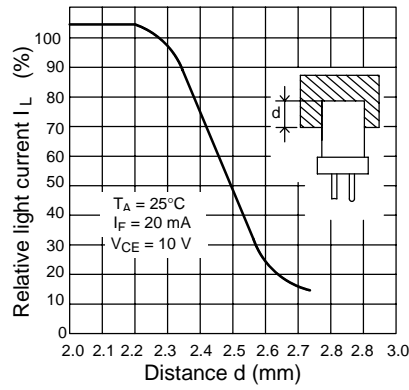

SWITCHING CHARACTERISTICS (TYPICAL)

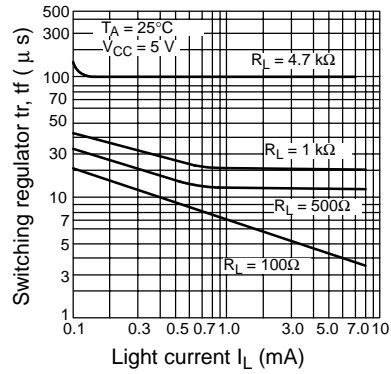

The t_r and t_f are almost the same in length.

Dimensions

Unit: mm (inch)

EE-SX1035

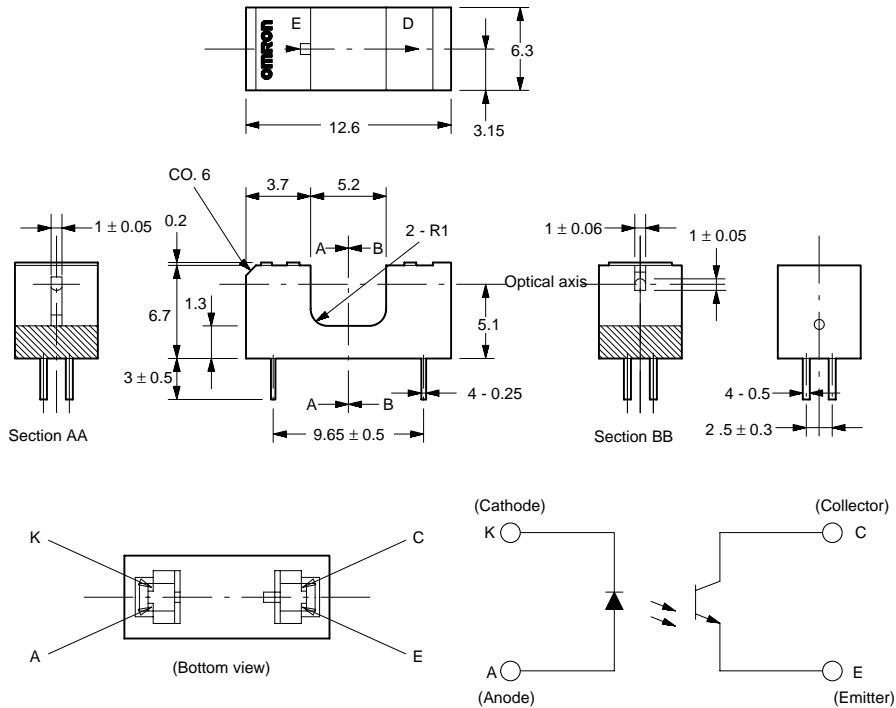
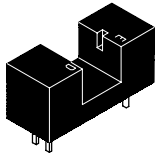

■ EE-SX1081

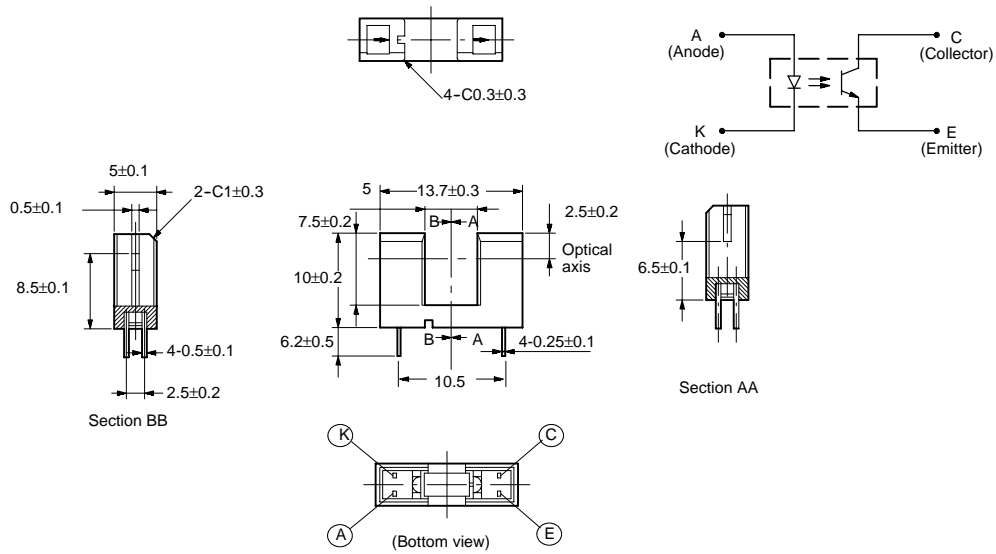
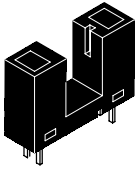

■ EE-SX1088

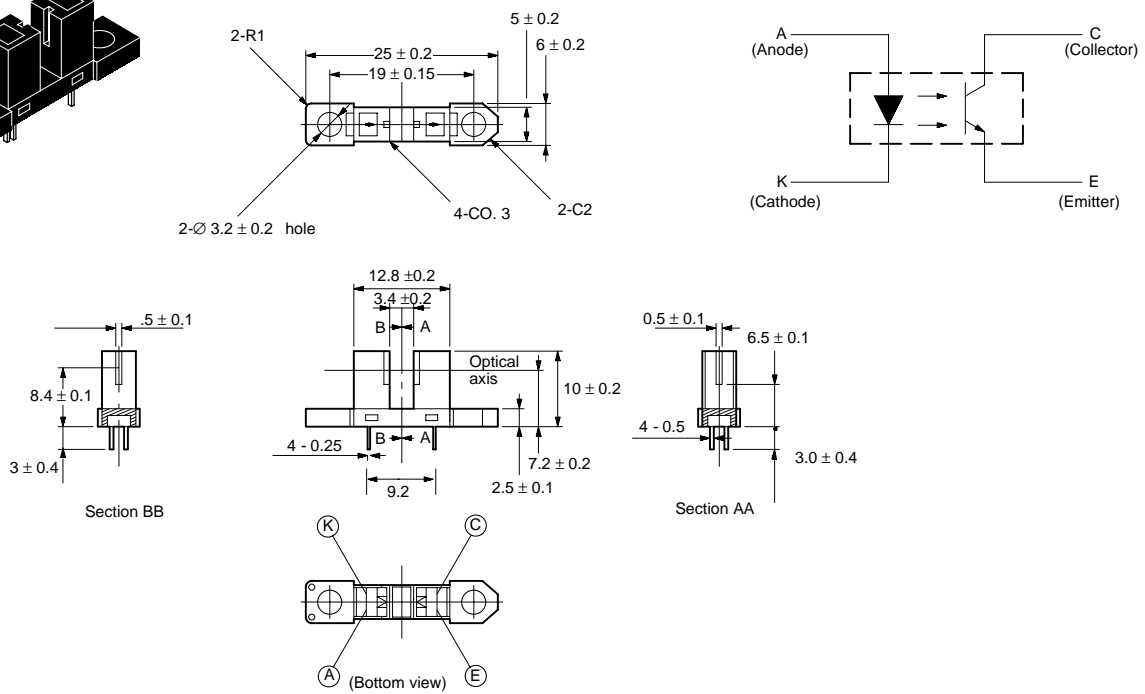
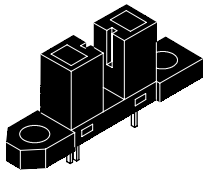

■ EE-SX1096

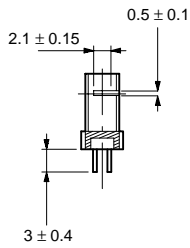
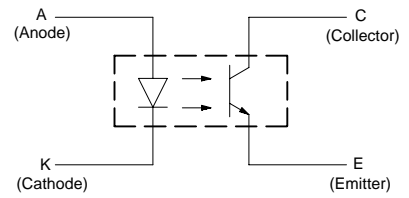
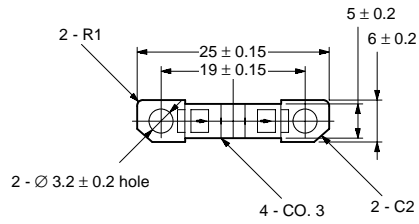
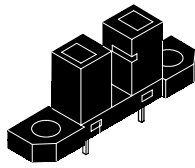

Section BB

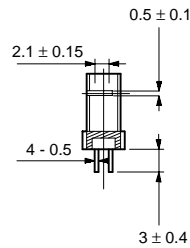
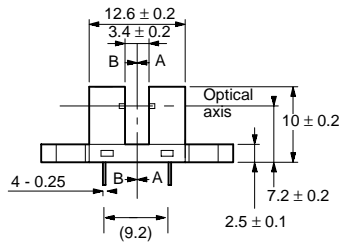

Section AA

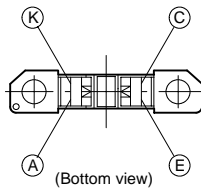

(Bottom view)

■ EE-SX1088-W1

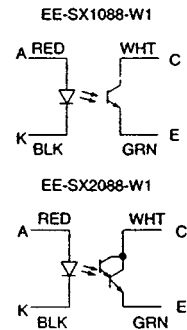
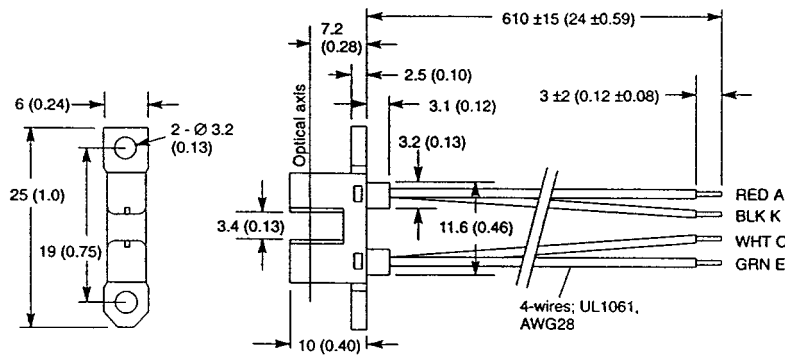
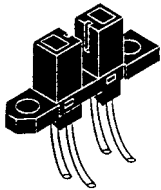

■ EE-SX1096-W1

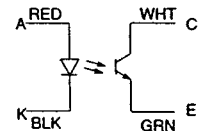
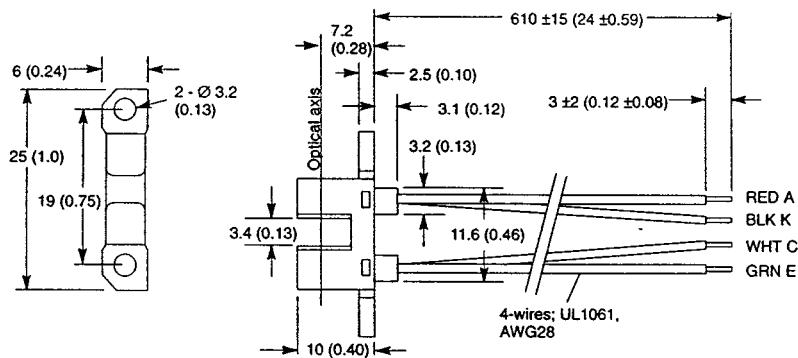
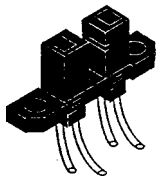

Precautions

Refer to the Technical Information Section for general precautions.

NOTE: DIMENSIONS SHOWN ARE IN MILLIMETERS. To convert millimeters to inches divide by 25.4.

OMRON[®]
OMRON ELECTRONICS, INC.
One East Commerce Drive
Schaumburg, IL 60173
1-800-55-OMRON

OMRON CANADA, INC.
885 Milner Avenue
Scarborough, Ontario M1B 5V8
416-286-6465