



# XS, Y92E

For a wide range of applications and environments the family of sensor connectors are the ideal match for the OMRON sensor portfolio. The line up is optimized to provide the best performance fit and value for money.

- M8, M12, fiber amplifier and photomicrosensor connectors
- 2, 3, 4, 5 and 8-wires
- wide application range from standard to special environments and performance requirements
- different cable and housing materials









## Table of content

<b>Cable connectors – quick guide and selection table</b> . . . . .	<b>. 2</b>
 <b>XS_-L – M8 and M12 Sensor Connectors.</b> . . . . .	<b>. 9</b>
 <b>XS_-EU – M8 and M12 Sensor Connectors</b> . . . . .	<b>. 4</b>
<b>XS2F-M12_LED – M12 Sensor connectors with LED.</b> . . . . .	<b>12</b>
<b>Y92E-M12_8 – M12 8-Pin Sensor Connectors</b> . . . . .	<b>14</b>
<b>XS5F – Twist &amp; click (M12)</b> . . . . .	<b>23</b>
<b>XS2C/G, XS5C/G, Y92E-_-conf – Confectionable plugs and connectors (self-assembly).</b> . . . . .	<b>24</b>
<b>XW3B, XW3D, DRT2 – Field I/O boxes</b> . . . . .	<b>27</b>
<b>E3X-CN – Fiber amplifier connectors.</b> . . . . .	<b>28</b>
<b>EE-1 – Photomicrosensor connectors</b> . . . . .	<b>30</b>
<b>XS2 – T-connectors, Covers, Accessories, extended wiring portfolio.</b> . . . . .	<b>32</b>
 <b>XS, Y92E – M8 and M12 Robotic Sensor Connectors</b> . . . . .	<b>15</b>
<b>Y92E-S – Detergent resistant cable connectors (M8 / M12).</b> . . . . .	<b>19</b>
<b>XS2F-_-E – Heat &amp; chemical resistant cable connectors</b> . . . . .	<b>21</b>

## Cable connectors – quick guide and selection table

Size	Shape	Type	Features	Material		Order code		Extended Portfolio and Specs on Page
				Nut	Cable			
M8		Pro Line	3 pin	Brass (CuZn)	PVC 2 m	XS3F-M8PVC3S2M-EU	XS3F-M8PVC3A2M-EU	4
			4 pin		PUR 2 m	XS3F-M8PUR3S2M-EU	XS3F-M8PUR3A2M-EU	
			4 pin		PVC 2 m	XS3F-M8PVC4S2M-EU	XS3F-M8PVC4A2M-EU	
					PUR 2 m	XS3F-M8PUR4S2M-EU	XS3F-M8PUR4A2M-EU	
		Lite Line	3 pin	Brass (CuZn)	PVC 2 m	XS3F-LM8PVC3S2M	XS3F-LM8PVC3A2M	9
			4 pin			XS3F-LM8PVC4S2M	XS3F-LM8PVC4A2M	
		Detergent resistant	4 pin	Stainless steel (SUS316L)	PVC 2 m	Y92E-S08PVC4S2M-L	Y92E-S08PVC4A2M-L	19
		Robotic (drag chain) High robotic (drag chain & torsion)	4 pin	Brass (CuZn)	Robotic PVC 2 m	XS3F-M421-402-R	XS3F-M422-402-R	15
					Robotic PUR 2 m	Y92E-M08PUR4S2M-L	Y92E-M08PUR4A2M-L	
					High robotic PUR 2 m	Y92E-M08PUR4S2M-R	Y92E-M08PUR4A2M-R	
M12 <sup>1</sup>		Pro Line	3 wire	Brass (CuZn)	PVC 2 m	XS2F-M12PVC3S2M-EU	XS2F-M12PVC3A2M-EU	4
			4 wire		PUR 2 m	XS2F-M12PUR3S2M-EU	XS2F-M12PUR3A2M-EU	
			4 wire		PVC 2 m	XS2F-M12PVC4S2M-EU	XS2F-M12PVC4A2M-EU	
					PUR 2 m	XS2F-M12PUR4S2M-EU	XS2F-M12PUR4A2M-EU	
			5 wire		PVC 2 m	XS2F-M12PVC5S2M-EU	XS2F-M12PVC5A2M-EU	
					PUR 2 m	XS2F-M12PUR5S2M-EU	XS2F-M12PUR5A2M-EU	
		Lite Line	3 wire	Brass (CuZn)	PVC 2 m	XS2F-LM12PVC3S2M	XS2F-LM12PVC3A2M	9
			4 wire			XS2F-LM12PVC4S2M	XS2F-LM12PVC4A2M	
		LED (power and output LED, PNP/NPN)	3 wire	Nickel plated brass	PVC 2 m	-	XS2F-M12PVC3A2MPLED	12
			4 wire			-	XS2F-M12PVC4A2MPLED	
			3 wire		PUR 2 m	-	XS2F-M12PUR3A2MPLED	
			4 wire			-	XS2F-M12PUR4A2MPLED	
		Detergent resistant	4 wire	Stainless steel (SUS316L)	PVC 2 m	Y92E-S12PVC4S2M-L	Y92E-S12PVC4A2M-L	19
		105°C Heat resistant	4 wire	Stainless steel (SUS316L)	Heat resistant PVC 2 m	XS2F-E421-D80-E	XS2F-E422-D80-E	21
	Twist & click	4 wire	Nickel plated Zinc	PVC 2 m	XS5F-D421-D80-F	XS5F-D422-D80-F	23	
				PUR 2 m	XS5F-D421-D80-P	XS5F-D422-D80-P		
	Robotic (drag chain) High robotic (drag chain & torsion)	4 wire	Brass (CuZn)	Robotic PVC 2 m	XS2F-D421-D80-F	XS2F-D422-D80-F	15	
				Robotic PUR 2 m	Y92E-M12PUR4S2M-L	Y92E-M12PUR4A2M-L		
				High grade robotic PUR 2 m	Y92E-M12PUR4S2M-R	Y92E-M12PUR4A2M-R		
	8 pin	8 wire shielded cable	Brass (CuZn)	Shielded PUR 2m	Y92E-M12PURSH8S2M-L	-	14	
Fiber amplifier (E3X) connector		Fiber amplifier connectors	Special fiber connector - 4 wire	PBT	PVC 2 m	E3X-CN21		28
			Special fiber connector+ M8 plug	Plug: Zinc diecast	PVC 30 cm with M8 4-pin plug	E3X-CN21-M3J-2 0.3M		
			Special fiber connector+ M12 plug		PVC 30 cm with M12 4-pin plug	E3X-CN21-M1J 0.3M		

Size	Shape	Type	Features	Material		Order code		Extended Portfolio and Specs on Page
				Nut	Cable			
Photo-micro-sensor (EE-SX) connector Cable connector		Cable connector	standard cable	Nylon	PVC 1 m	EE-1017 1M		30
			robotic cable			EE-1017-R 1M		30
M8/M12		Confectionable	Plugs and connectors for self assembly	Brass	n.a.	XS2C/G, XS5C/G Y92E_conf		24
M12		Field I/O boxes	Direct wiring or DeviceNet communication	–	–	XW3B, DRT2		27
M8/M12		T-connectors, covers, accessories and extended wiring portfolio	n.a.	–	–	XS2R, XS3R, XY2F, ...		32

\*1 For details on pin configuration refer to specifications

# M8 and M12 Sensor Connectors

# XS\_-EU











For a wide range of applications the XS\_-EU family of M8 and M12 sensor connectors provides the high performance and features making the family the ideal choice for standard as well as challenging applications.

- M8 and M12 brass female connectors with PVC or PUR cables
- suitable for fixed and occasionally moving installations (>1 million bending cycles in drag chains)
- easy identification (non-removable order code and lot nr printed on the cable)
- enhanced lifetime in standard and challenging environments (tested and certified)



## Ordering Information

Type	Size	Cable material	Features	Shape	Cable length <sup>1</sup>	Order code
Sensor connector with open cable end for a wide range of fixed and occasionally moving applications.	M8	PVC	3-wire		2 m	XS3F-M8PVC3S2M-EU
					5 m	XS3F-M8PVC3S5M-EU
				2 m	XS3F-M8PVC3A2M-EU	
				5 m	XS3F-M8PVC3A5M-EU	
		4-wire		2 m	XS3F-M8PVC4S2M-EU	
				5 m	XS3F-M8PVC4S5M-EU	
				2 m	XS3F-M8PVC4A2M-EU	
				5 m	XS3F-M8PVC4A5M-EU	
	PUR	3-wire		2 m	XS3F-M8PUR3S2M-EU	
				5 m	XS3F-M8PUR3S5M-EU	
				2 m	XS3F-M8PUR3A2M-EU	
				5 m	XS3F-M8PUR3A5M-EU	
		4-wire		2 m	XS3F-M8PUR4S2M-EU	
				5 m	XS3F-M8PUR4S5M-EU	
				2 m	XS3F-M8PUR4A2M-EU	
				5 m	XS3F-M8PUR4A5M-EU	
	M12	PVC	3-wire		2 m	XS2F-M12PVC3S2M-EU
					5 m	XS2F-M12PVC3S5M-EU
			4-wire		2 m	XS2F-M12PVC3A2M-EU
					5 m	XS2F-M12PVC3A5M-EU
				2 m	XS2F-M12PVC4S2M-EU	
				5 m	XS2F-M12PVC4S5M-EU	
5-wire			2 m	XS2F-M12PVC4A2M-EU		
			5 m	XS2F-M12PVC4A5M-EU		
			2 m	XS2F-M12PVC5S2M-EU		
			5 m	XS2F-M12PVC5S5M-EU		
			2 m	XS2F-M12PVC5A2M-EU		
			5 m	XS2F-M12PVC5A5M-EU		
PUR	3-wire		2 m	XS2F-M12PUR3S2M-EU		
			5 m	XS2F-M12PUR3S5M-EU		
	3-wire		2 m	XS2F-M12PUR3A2M-EU		
			5 m	XS2F-M12PUR3A5M-EU		
			2 m	XS2F-M12PUR3S2M-EU		
			5 m	XS2F-M12PUR3S5M-EU		

Type	Size	Cable material	Features	Shape	Cable length <sup>1</sup>	Order code
Sensor connector with open cable end for a wide range of fixed and occasionally moving applications.	 M12	PUR	4-wire		2 m	XS2F-M12PUR4S2M-EU
					5 m	XS2F-M12PUR4S5M-EU
			5-wire		2 m	XS2F-M12PUR4A2M-EU
					5 m	XS2F-M12PUR4A5M-EU
	 M12	PUR	4-wire		2 m	XS2F-M12PUR5S2M-EU
					5 m	XS2F-M12PUR5S5M-EU
			5-wire		2 m	XS2F-M12PUR5A2M-EU
					5 m	XS2F-M12PUR5A5M-EU

<sup>1</sup> Models with cable lengths 10 m, 15 m and 20 m are available. For ordering replace the length information in the model of your choice with the longer length.  
 Example for 10 m: XS2F-M12PVC4S10M  
 Example for 15 m: XS2F-M12PVC4S15M  
 Example for 20 m: XS2F-M12PVC4S20M

## Specifications

		M8	M12
Wire size	PVC	0.25 mm <sup>2</sup>	0.25 mm <sup>2</sup>
	PUR	0.34 mm <sup>2</sup>	0.34 mm <sup>2</sup>
Rated current		1 A	4 A
Rated voltage		125 VDC	
Degree of protection		IP67 (IEC 60529) IP69k (DIN 40050 part 9)	
Screw tightening torque		0.2 Nm	
Contact resistance		40 mΩ max. (20 mV max., 100 mA max.)	
Insulation resistance		1,000 MΩ min. (at 500 VDC)	
Dielectric strength		1,500 VAC for 1 min (leakage current: 1 mA max.)	
Ambient temperature	PUR	Fixed cable: -40°C to 80°C Moving cable: -20°C to 80°C	
	PVC	-20°C to 80°C	
Ambient humidity		20 to 85% RH	
Enhanced lifetime tests		Continuous heat (dry heat, damp heat) Temperature change (hot and cold air, hot and cold water) Shock (multi direction acceleration) Vibration Corrosion (in gas environment) Connector insertion durability High pressure water For details on above extended lifetime verification tests contact your OMRON representative	
Rated standards		NECA 4202 IEC 61076-2-101 JIS C8201-5-2 cULus (files nr CYJV2.E207683 and CYJV8.E207683); cables AWM 2464 (PVC) and AWM 20936 (PUR)	

## Pin arrangement

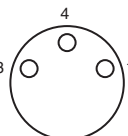
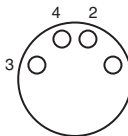
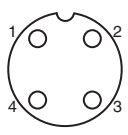
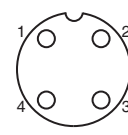
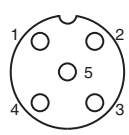
M8 3-pin		M8 4-pin			
	1 = brown 3 = blue 4 = black		1 = brown 2 = white 3 = blue 4 = black		
M12 3-wire		M12 4-wire		M12 5-wire	
	1 = brown 2 = n.c. 3 = blue 4 = black		1 = brown 2 = white 3 = blue 4 = black		1 = brown 2 = white 3 = blue 4 = black 5 = green/yellow

## Materials

<b>Pin block</b>		PBT resin with glass (UL 94V-0)
<b>Contacts</b>		3- and 4-wire: Phosphor bronze/nickel base, 0.4µm gold plating 5-wire: Brass/nickel base, 0.4 µm gold plating
<b>Fixture</b>		Brass/nickel plated
<b>Cover</b>		PBT/black
<b>O-ring</b>		Rubber
<b>Cable</b>	<b>PVC</b>	Outer sheath:PVC Inner cables:PVC
	<b>PUR</b>	Outer sheath:PUR Inner cables:Polypropylene (connector is halone-free)
<b>Outer Diameter</b>		(refer to dimension drawings)
<b>Colour</b>		Black

## Dimensions

(Unit: mm)  
Tolerance class IT16 applies to dimensions in this data sheet unless otherwise specified.

### XS3F

#### M8 Screw-on cable connectors

##### 3-wire

Straight connectors

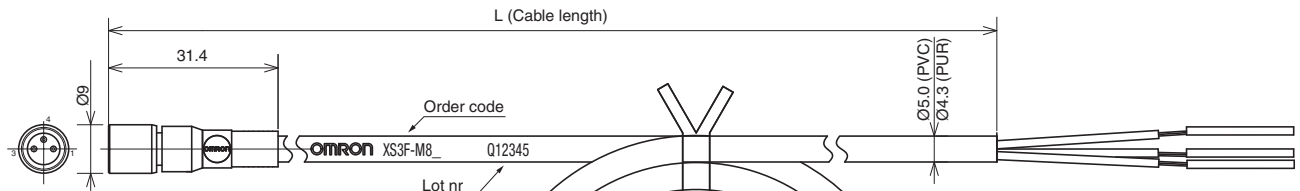

L-shaped connectors

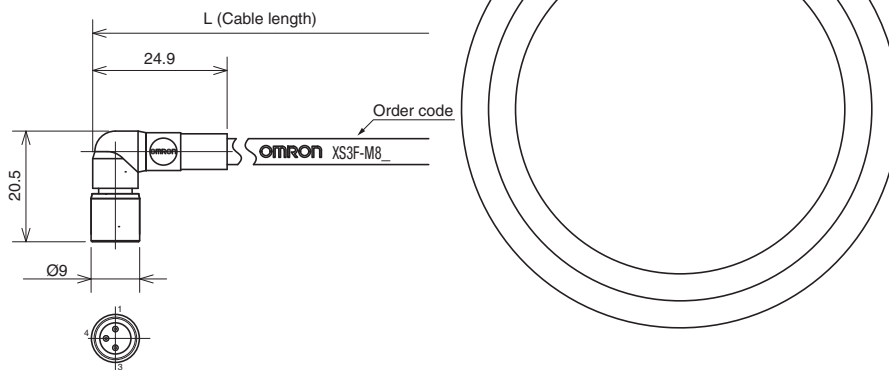

**4-wire**

Straight connectors

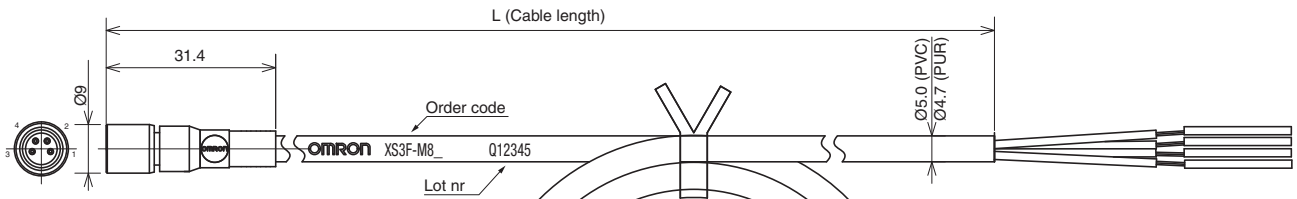

L-shaped connectors

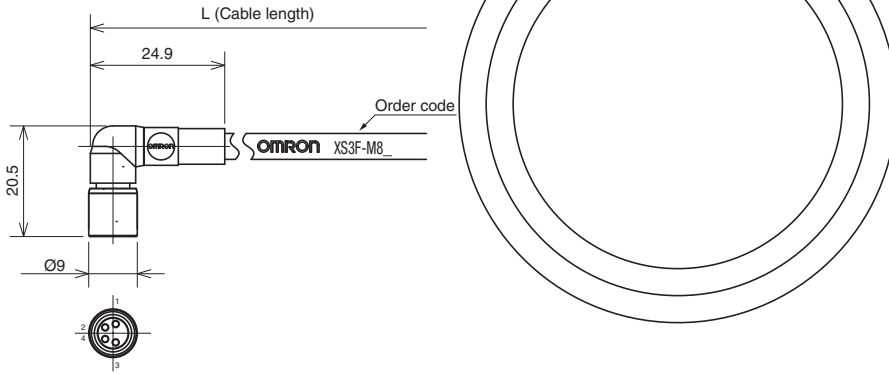

**XS2F**

**M12 Screw-on cable connectors**

**3-wire**

Straight connectors

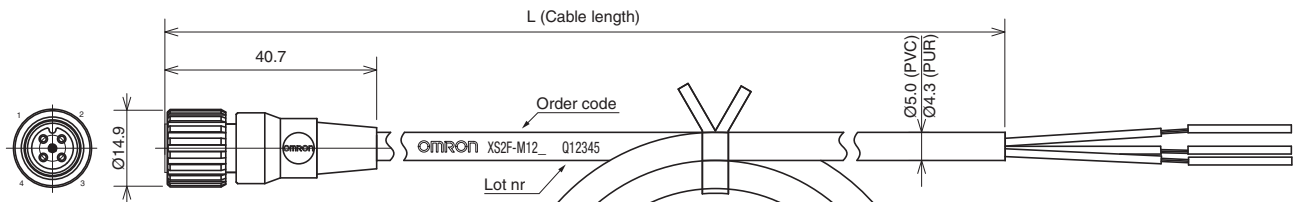

L-shaped connectors

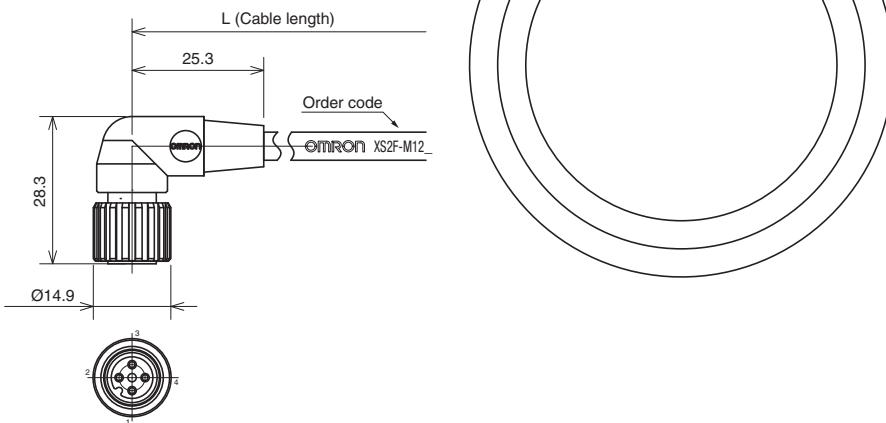

## 4-wire

### Straight connectors

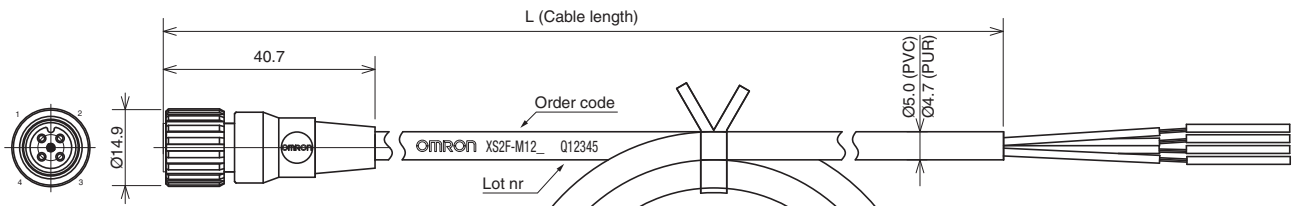

### L-shaped connectors

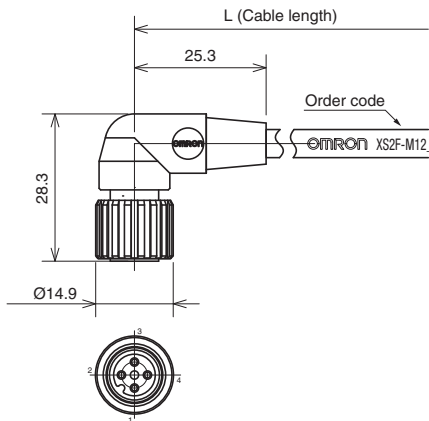

## 5-wire

### Straight connectors

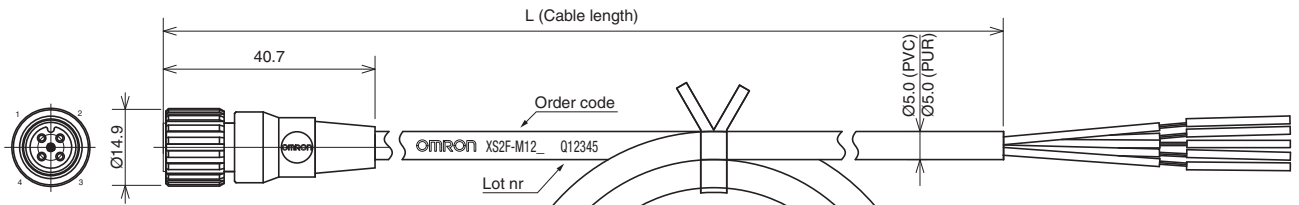

### L-shaped connectors

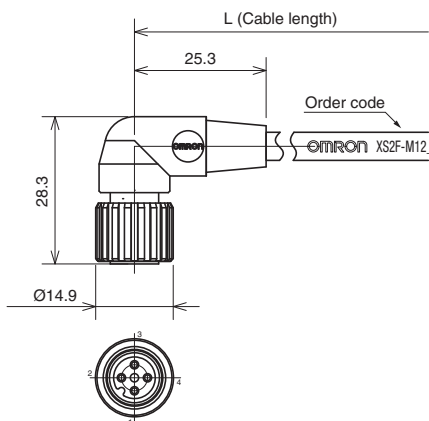



# M8 and M12 Sensor Connectors









# XS\_-L

The XS\_-L family provides reliable operation in standard factory environments. The M8 and M12 sensors are designed to match the specifications of OMRON Lite Line sensors and provide excellent value for money.

- M8 and M12 brass female connectors
- 3-wire and 4-wire PVC cables
- ideal specification match for sensor usage in standard factory environments



## Ordering Information

Type	Size	Cable material	Features	Shape	Cable length	Order code	
Sensor connector with open cable end for standard factory environments	M8  	PVC	3-wire		2 m	XS3F-LM8PVC3S2M	
					5 m	XS3F-LM8PVC3S5M	
					2 m	XS3F-LM8PVC3A2M	
			5 m		XS3F-LM8PVC3A5M		
			M12 	3-wire		2 m	XS2F-LM12PVC3S2M
						5 m	XS2F-LM12PVC3S5M
					2 m	XS2F-LM12PVC3A2M	
				5 m	XS2F-LM12PVC3A5M		
	4-wire				2 m	XS2F-LM12PVC4S2M	
					5 m	XS2F-LM12PVC4S5M	
				2 m	XS2F-LM12PVC4A2M		
	5 m			XS2F-LM12PVC4A5M			

## Specifications

	M8	M12
Wire size	0.25 mm <sup>2</sup>	0.34 mm <sup>2</sup>
Rated current	0.5 A	0.8 A
Rated voltage	30 VDC	
Degree of protection	IP67 (IEC 60529)	
Ambient temperature	-10°C to 65°C	

## Pin arrangement

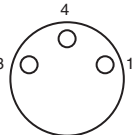
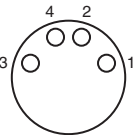
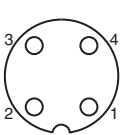
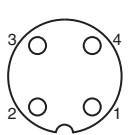
M8 3-wire	M8 4-wire	M12 3-wire	M12 4-wire
 1 = brown 3 = blue 4 = black	 1 = brown 2 = white 3 = blue 4 = black	 1 = brown 2 = n.c. 3 = blue 4 = black	 1 = brown 2 = white 3 = blue 4 = black

# Dimensions

(Unit: mm)  
Tolerance class IT16 applies to dimensions in this data sheet unless otherwise specified.

## XS3F

### M8 Screw-on cable connectors

#### 3-wire

Straight connectors

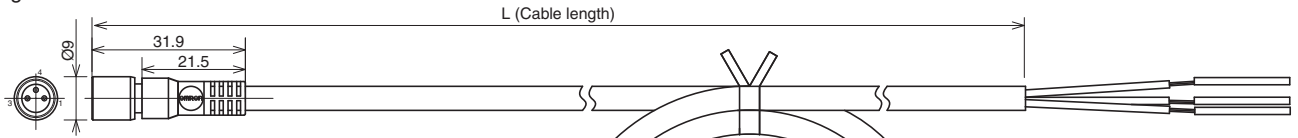

L-shaped connectors

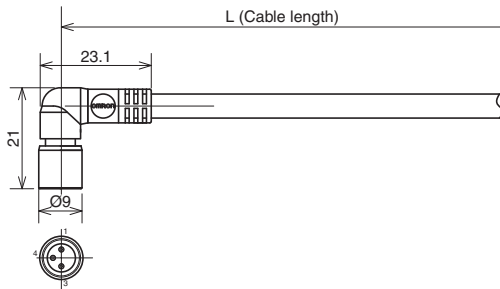

#### 4-wire

Straight connectors

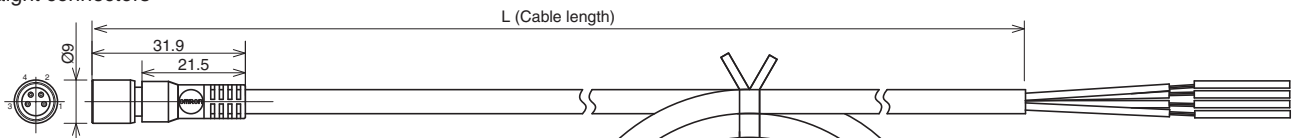

L-shaped connectors

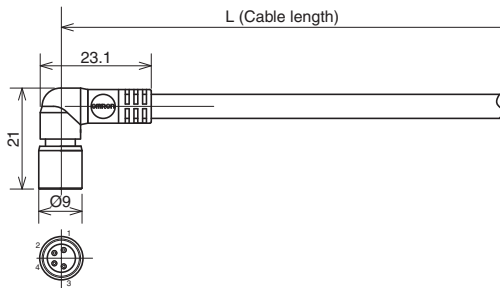

**XS2F**

**M12 Screw-on cable connectors**

**3-wire**

Straight connectors

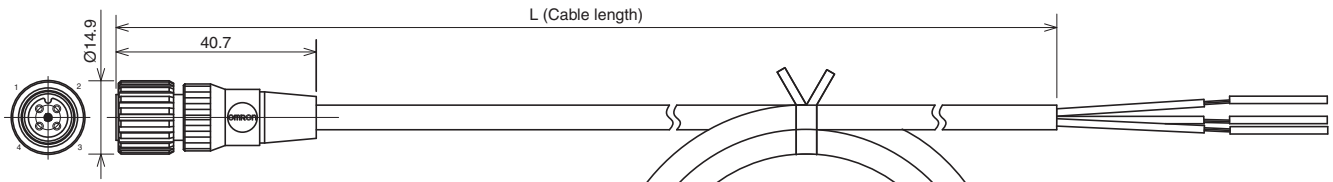

L-shaped connectors

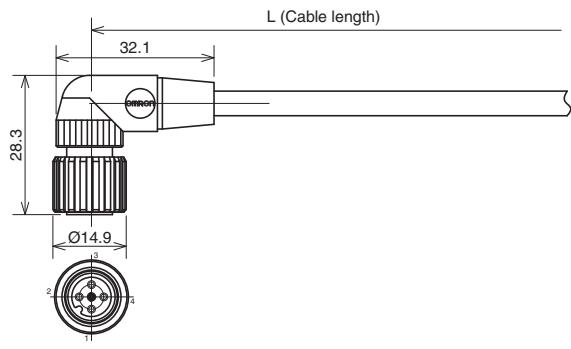

**4-wire**

Straight connectors

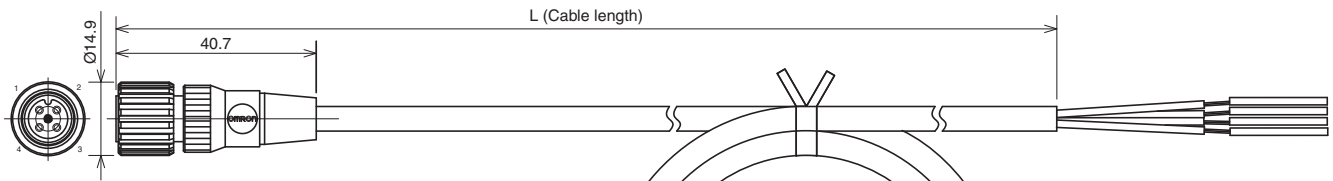

L-shaped connectors

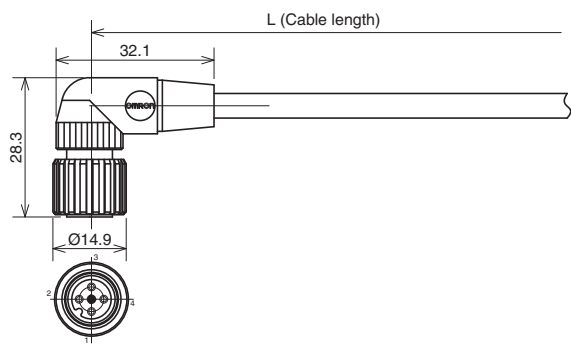

# XS2F-M12\_LED

## Water- and Environment-resistive FA Connectors

### Save Wiring and Maintenance Effort

- Compact FA connectors meet IP67 requirements and ensure a 94V-0 fire retardant rating.
- A wide array of connectors makes a wiring system more modular, simplifies maintenance, and reduces downtime.
- IEC61076-2-101(IEC60947-5-2)
- Lineup of connectors with LEDs for easy visual confirmation of Sensor operating status.



## Ordering Information

Cable type	No. of cable cores	Cable outer diameter	Cable connection direction	Cable length (m)	LED	Model
PVC	3	5.0 dia.	Right-angle	2	PNP	XS2F-M12PVC3A2MPLED
				5		XS2F-M12PVC3A5MPLED
				10		XS2F-M12PVC3A10MPLED
				2	NPN	XS2F-M12PVC3A2MNLED
				5		XS2F-M12PVC3A5MNLED
				10		XS2F-M12PVC3A10MNLED
PUR	4	5.4 dia		2	PNP	XS2F-M12PVC4A2MPLED
				5		XS2F-M12PVC4A5MPLED
				10		XS2F-M12PVC4A10MPLED
				2		XS2F-M12PUR3A2MPLED
				5		XS2F-M12PUR3A5MPLED
				10		XS2F-M12PUR3A10MPLED
PUR	3	4.3 dia	2	PNP		XS2F-M12PUR4A2MPLED
			5			XS2F-M12PUR4A5MPLED
			10			XS2F-M12PUR4A10MPLED
			2			XS2F-M12PUR4A2MPLED
			5			XS2F-M12PUR4A5MPLED
			10			XS2F-M12PUR4A10MPLED

## Ratings and Specifications

Item	XS2F-M12□□□□□□□□M	XS2F-M12□□□□□A□□M□LED
Rated current	4A	
Rated voltage	125 VDC	24 VDC
Contact resistance (Connector)	40 mΩ max. (20 mV max., 100 mA max.)	
Insulation resistance	1,000 MΩ min. (at 500 VDC)	-
Dielectric strength (Connector)	AC 1,500 V 1 min. (leakage current: 1 mA max.)	-
Degree of protection	IP67 (IEC60529)	

## Materials and Finish

Contacts	Copper alloy/ nickel base, gold plating
Pin block	PBT resin (UL94 V-0)
Fixtures	Copper alloy/ nickel plating
Cover	PBT resin (UL94V-0)

(Unit: mm)

**Dimensions**

**Right-angle**

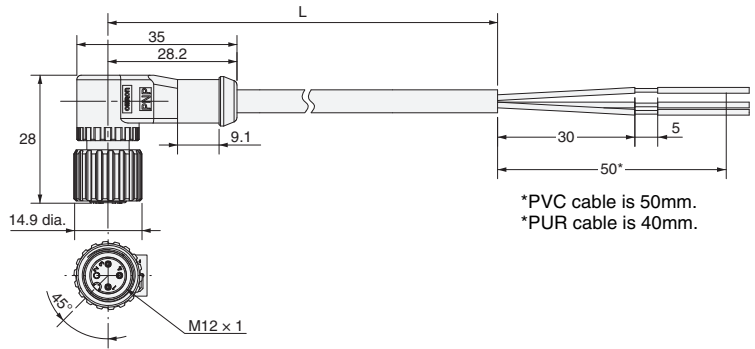

**Wiring Diagram**

3 Cores		4 Cores
NPN type	PNP type	PNP type

# Y92E-M12\_8

For the connection of sensors with M12 8-pin connectors, the Y92E-M12\_8 family provides error-free signal transmission in standard and challenging environments.

- M12 8-pin brass connectors
- Halone-free PUR cable with outer shielding layer



## Ordering Information

Type	Size	Cable material	Features	Shape	Cable length	Order code
Sensor connector with open cable end	M12	PUR	8-pin, outer shielding layer		2 m	Y92E-M12PURSH8S2M-L
					5 m	Y92E-M12PURSH8S5M-L
					10 m	Y92E-M12PURSH8S10M-L
					25 m	Y92E-M12PURSH8S25M-L
Female-male extension connector				0.6 m	Y92E-M12FSM12MSPURSH806M-L	
					2 m	Y92E-M12FSM12MSPURSH82M-L
					5 m	Y92E-M12FSM12MSPURSH85M-L
Male-male extension connector				10 m	Y92E-M12FSM12MSPURSH810M-L	
					0.3 m	Y92E-M12MSM12MSPURSH80.3M-L
					0.9 m	Y92E-M12MSM12MSPURSH80.9M-L
					0.9 m	Y92E-M12MSM12MSPURSH80.9M-L

## Specifications

		Y92E-M12_8
Wire size	0.25 mm <sup>2</sup>	
Rated current	4 A	
Rated voltage	30 VDC	
Degree of protection	IEC 60529: IP67	
Ambient temperature	-25°C to 80°C	
Rated standards	AWM 21198	
	Flame retardant	IEC 60332-2-2 CSA FT2
	Halone free	IEC 60754-1
	RoHS	2002/95/EC

## Dimensions

(Unit: mm)  
Tolerance class IT16 applies to dimensions in this data sheet unless otherwise specified.

### Y92E-M12\_8 (female)

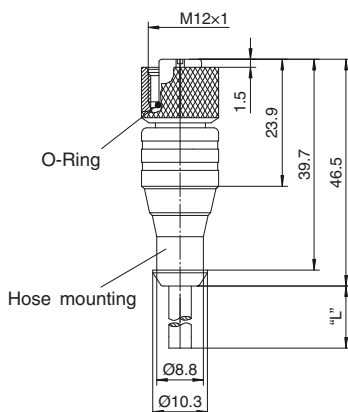

### Y92E-M12\_8 (male)

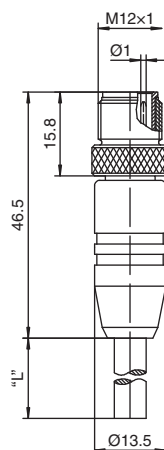

### Pin arrangement

M12 8-pin (female)	
	1 = white 2 = brown 3 = green 4 = yellow 5 = grey 6 = pink 7 = blue 8 = red
M12 8-pin (male)	
	1 = white 2 = brown 3 = green 4 = yellow 5 = grey 6 = pink 7 = blue 8 = red

# M8 and M12 Robotic Sensor Connectors











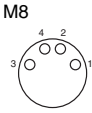







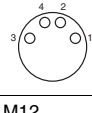

# XS, Y92E

For demanding applications in drag chains or in the moving parts of robots, the robotic sensor connector family provides the bending and torsion performance required for reliable and long life operation.

- M8 and M12 brass female connectors
- suitable for frequently or constantly moving applications
- > 2 Mio drag chain bending performance PVC or PUR models
- > 5 Mio drag chain bending and > 10 Mio torsion performance PUR models



## Ordering Information

Type	Size	Cable material	Bending performance (drag chain)	Torsion performance	Features	Shape	Cable length	Order code					
Sensor connector with open cable end and robotic cable	M8 	PVC	> 2 Mio	(not specified)	4-wire		2 m	XS3F-M421-402-R					
							5 m	XS3F-M421-405-R					
		PUR					2 m	XS3F-M422-402-R					
							5 m	XS3F-M422-405-R					
		M12 				PVC		2 m	Y92E-M08PUR4S2M-L				
								5 m	Y92E-M08PUR4S5M-L				
	PUR						2 m	Y92E-M08PUR4A2M-L					
							5 m	Y92E-M08PUR4A5M-L					
	Sensor connector with open cable end and high grade robotic cable					M8 	PUR	> 5 Mio	> 10 Mio	4-wire		2 m	XS2F-D421-D80-F
												5 m	XS2F-D421-G80-F
		M12 										2 m	XS2F-D422-D80-F
											5 m	XS2F-D422-G80-F	
			2 m	Y92E-M12PUR4S2M-L									
		5 m	Y92E-M12PUR4S5M-L										
	2 m	Y92E-M12PUR4A2M-L											
	5 m	Y92E-M12PUR4A5M-L											

## Bending and torsion performance

The bending and torsion performance of the robotic sensor connectors has been tested using the below test methods.

### 1. Bending (drag chain)

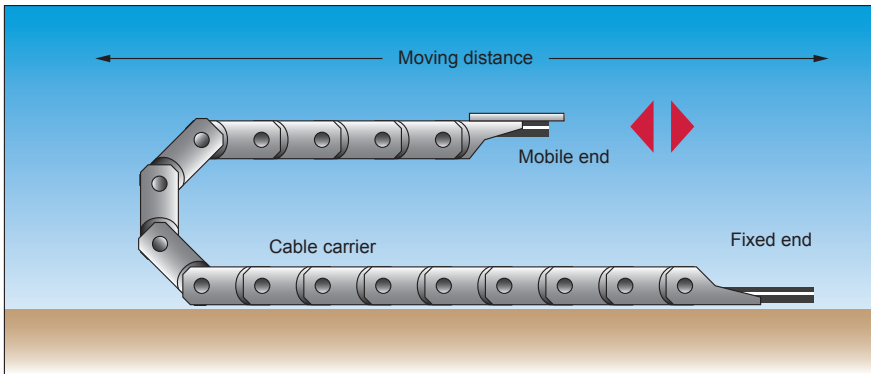

Cable carrier bending radius: approx.  $9 \times$  cable outer diameter

Movement speed: PVC: 120 m/min (max)

PUR: 200 m/min (max); max 5 m/s<sup>2</sup>

### 2. Bending (left - right)<sup>\*1</sup>

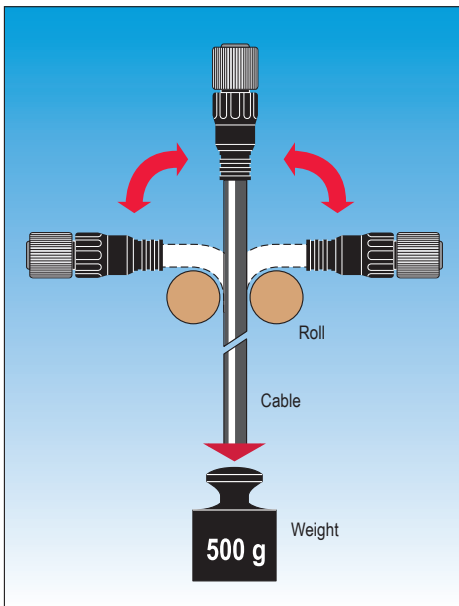

Bending angle:  $\pm 90^\circ$

Bending speed: 35 cycles/min

Roll diameter: 60 mm

<sup>\*1</sup> For PVC models

### 3. Torsion

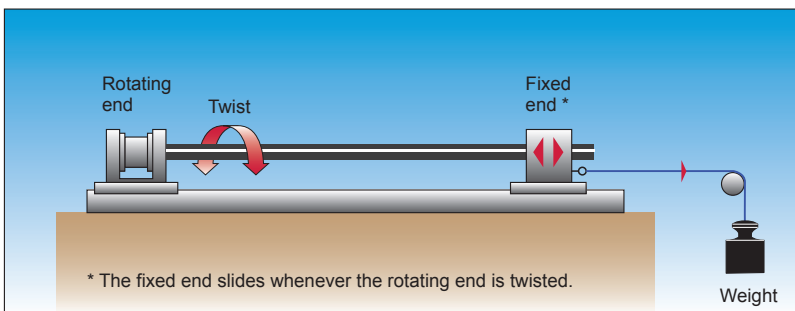

Torsion angle and length: PVC:  $\pm 180^\circ$  over 0.5 m

PUR:  $\pm 360^\circ$  over 1 m



# Specifications

	Robotic PVC		Robotic PUR		High grade robotic PUR	
	XS3F-_-R	XS2F-_-F	Y92E-M_-L		Y92E-M_-R	
	M8	M12	M8	M12	M8	M12
Wire size	0.25 mm <sup>2</sup>		0.34 mm <sup>2</sup>			
Rated current	1A		4A			
Rated voltage	125 VDC		30 VDC	240 VDC	30 VDC	240 VDC
Degree of protection	IEC 60529: IP67					
Ambient temperature	Fixed			-50°C to 80°C		
	Moving			-25°C to 80°C		
	Continuous drag chain operation	-25° to 70°C		-25°C to 60°C		5°C to 60°C
Rated standards	Style	-	AWM 2464	AWM 20549		
	Flame retardant	-	UL VW1 CSA FT4	IEC 60332-2-2 CSA FT2		
	Halone free	-		IEC 60754-1		
	RoHS	2002/95/EC				

## Pin arrangement

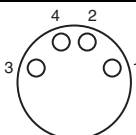
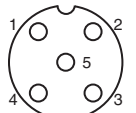
M8 4-pin	M12 4-wire
 <p>1 = brown 2 = white 3 = blue 4 = black</p>	 <p>1 = brown 2 = white 3 = blue 4 = black 5 = n.c.</p>

## Dimensions

(Unit: mm)  
Tolerance class IT16 applies to dimensions in this data sheet unless otherwise specified.

### XS3F-\_-R

#### Straight Connectors

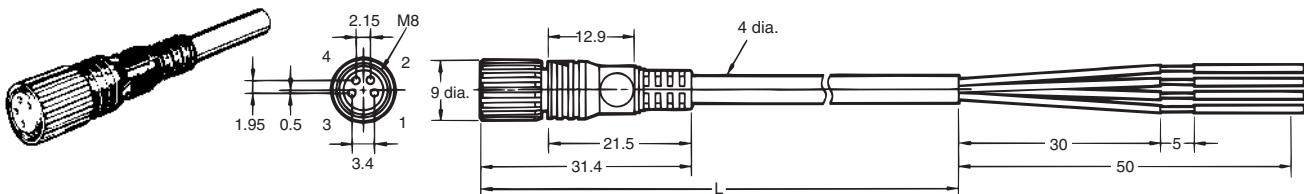

#### L-shaped Connectors

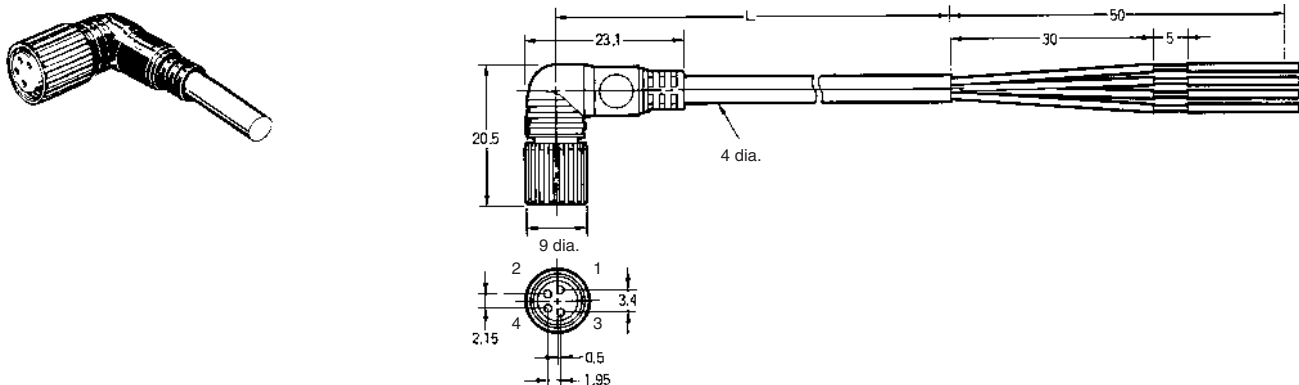

## XS2F-\_-F

### Straight Connectors

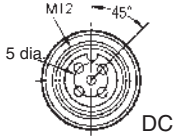
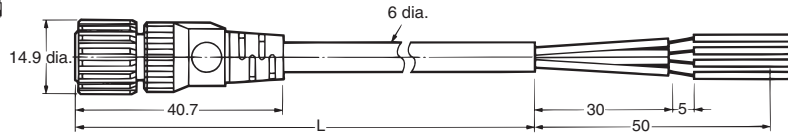
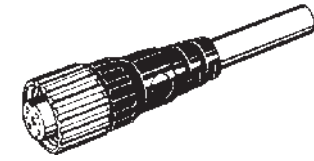

### L-shaped Connectors

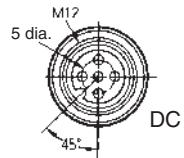
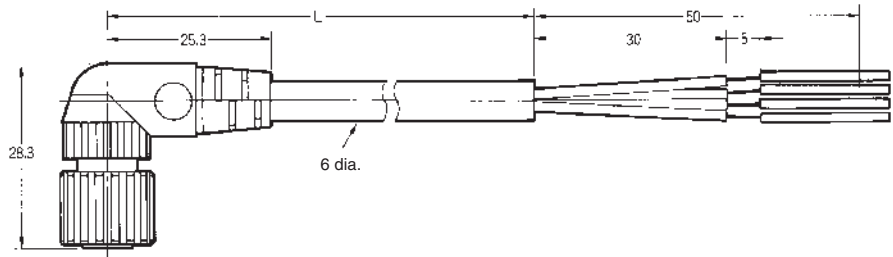

## Y92E-M08\_

### Straight Connectors

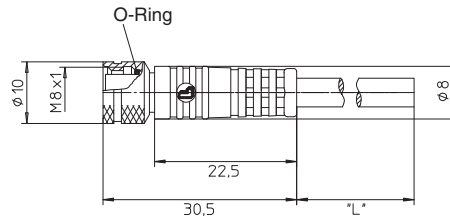
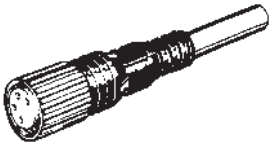

### L-shaped Connectors

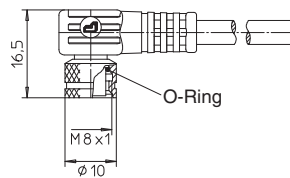

## Y92E-M12\_

### Straight Connectors

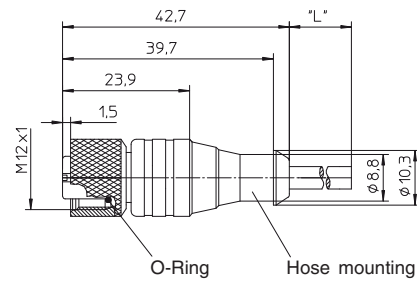
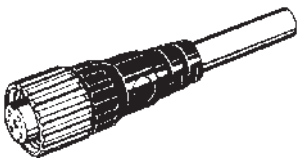

### L-shaped Connectors

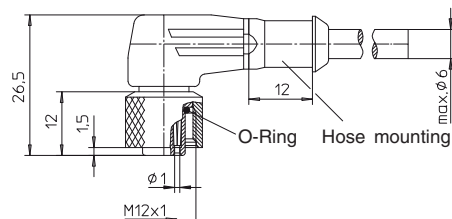

# Y92E-S

## Ordering information

### Detergent resistant models

Type	Size	Material		Features	Shape	Length (m) <sup>1</sup>	Order code
		Nut	Cable				
detergent resistant	M8	SUS 316L	PVC	3 pin	Angled	2	Y92E-S08PVC3A2M-L
						5	Y92E-S08PVC3A5M-L
					Straight	2	Y92E-S08PVC3S2M-L
					5	Y92E-S08PVC3S5M-L	
				4 pin	Angled	2	Y92E-S08PVC4A2M-L
						5	Y92E-S08PVC4A5M-L
	Straight	2	Y92E-S08PVC4S2M-L				
		5	Y92E-S08PVC4S5M-L				
	M12	SUS 316L	PVC	4 pin	Angled	2	Y92E-S12PVC4A2M-L
						5	Y92E-S12PVC4A5M-L
					Straight	2	Y92E-S12PVC4S2M-L
					5	Y92E-S12PVC4S5M-L	

<sup>1</sup> For different cable length please contact your Omron representative

## Specifications

Rated current	4 A
Rated voltage	M8: 30 VDC M12 4-wire: 250 VDC
Degree of protection	IP67 (IEC 60529); IP69k (after DIN 40050-1)
Ambient temperature	-25°C to +70°C

## Pin arrangement

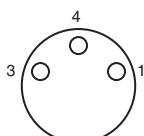
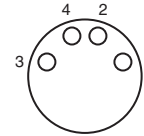
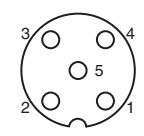
M8 3 pin		M8 4 pin		M12 4 pin	
	1 = brown 3 = blue 4 = black		1 = brown 2 = white 3 = blue 4 = black		1 = brown 2 = white 3 = blue 4 = black 5 = n.c.

## Materials

Pin block	PVC
Contacts	CuSn, nickel base, 0.3 μm gold plating
Fixture	Stainless steel
Cover	PVC
O-ring	EPDM

Dimensions

Y92E-S08

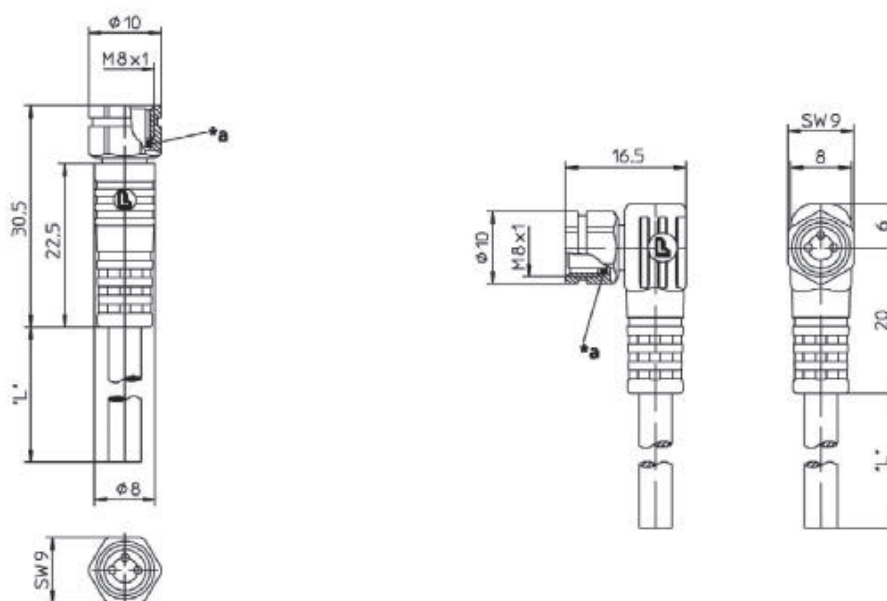

Y92E-S12

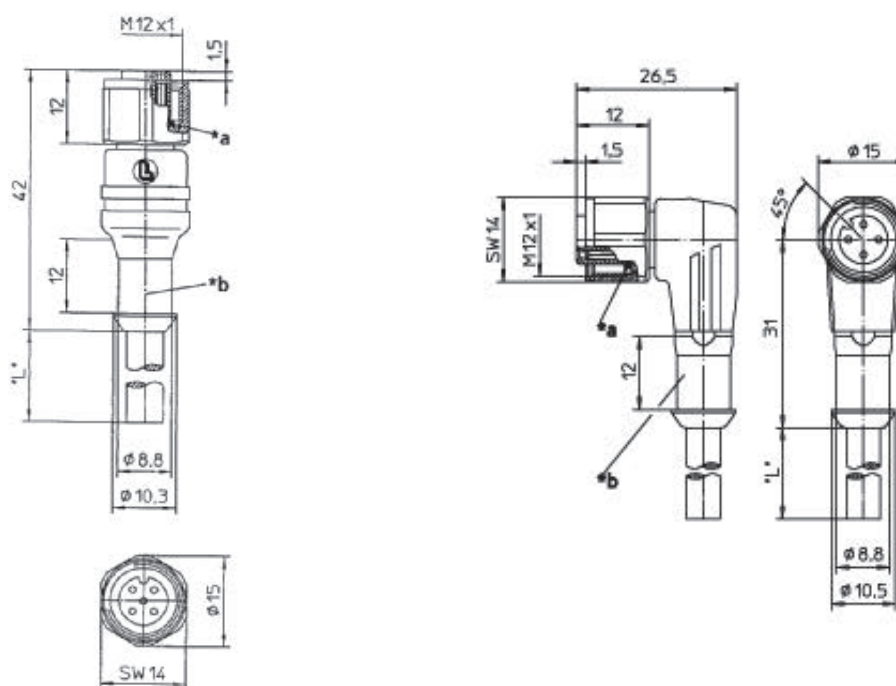

Wiring Diagram (M8 and M12)

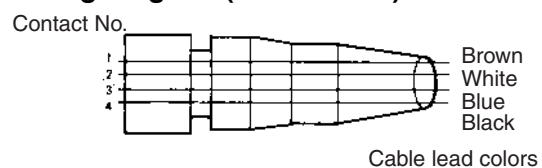

# XS2F-\_-E

## Ordering information

Type	Size	Material		Features	Shape	Length (m)	Order code
		Nut	Cable				
Heat and detergent resistant	M12	SUS316L	Heat resistant PVC	4 pin	straight	2	XS2F-E421-D80-E
						5	XS2F-E421-G80-E
					angled	2	XS2F-E422-D80-E
						5	XS2F-E422-G80-E

## Specifications

Rated current	3 A
Rated voltage	125 VDC, 250 VAC
Degree of protection	IP67 (IEC 60529); IP69k (DIN 40050 part 9)
Ambient temperature	-25°C to 105°C

## Pin arrangement

### M12 4 pin

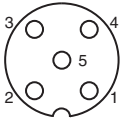

- 1 = brown
- 2 = white
- 3 = blue
- 4 = black
- 5 = n.c.

## Materials

Pin block	PBT (UL94V-0), light gray
Contacts	Phosphor bronze, nickel base, 0.4 µm gold plating
Fixture	SUS316L
Cover	TPEE (UL94V-0), black
O-ring	Rubber

Dimensions

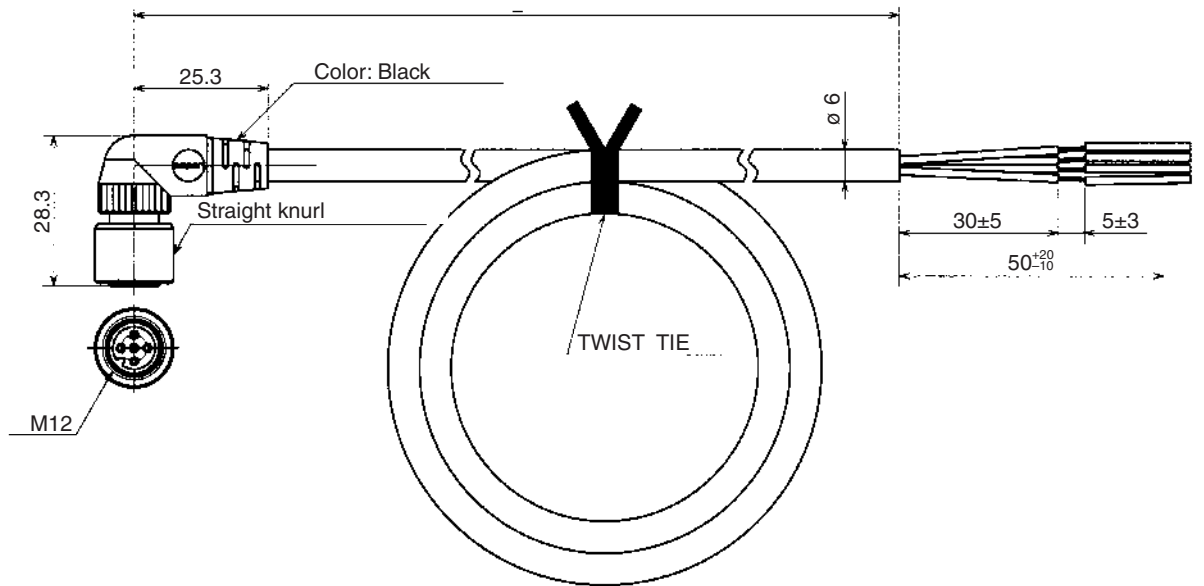
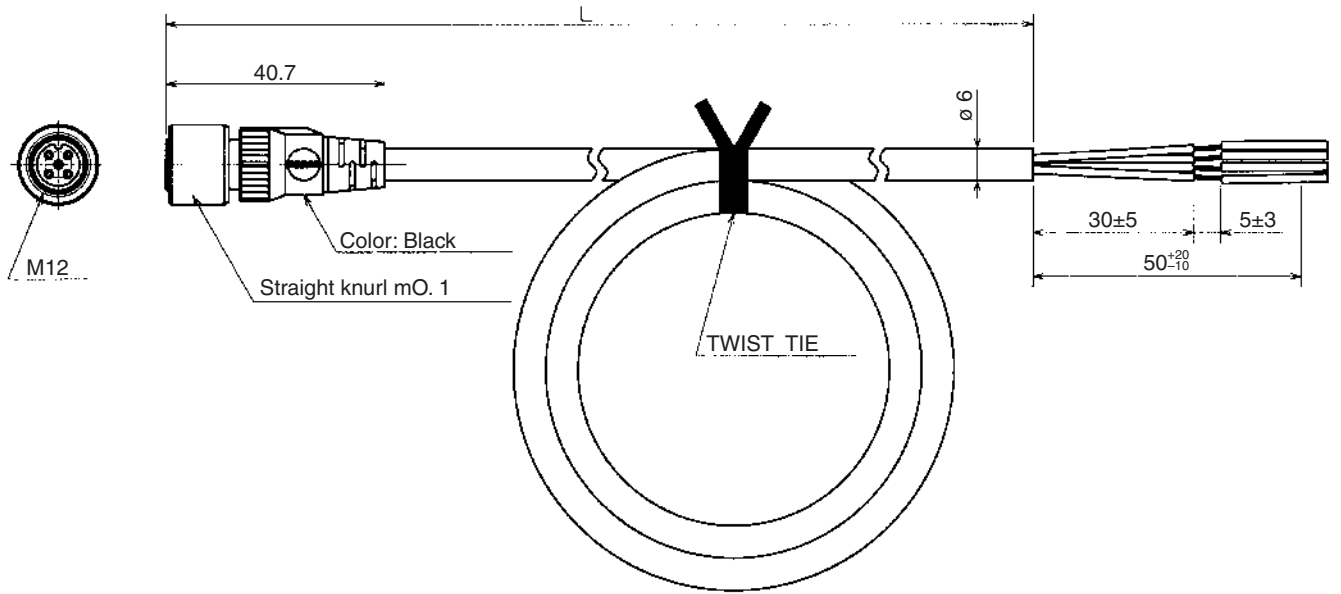

Wiring Diagram (M12)

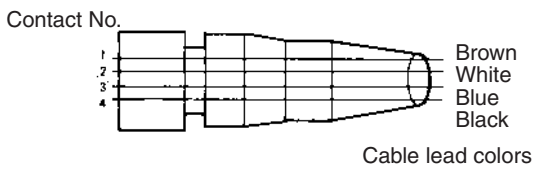

## Ordering information

Type	Size	Material		Features	Shape	Length (m)	Order code
		Nut	Cable				
Twist & Click <sup>*1</sup>	M12	Brass	PVC <sup>*2</sup>	For standard 4 pin or Omron Smartclick connectors	Angled	2	XS5F-D422-D80-F
						5	XS5F-D422-G80-F
					Straight	2	XS5F-D421-D80-F
						5	XS5F-D421-G80-F

<sup>\*1</sup> The XS5F connectors can be attached to standard M12 plug connectors (screw-fix) and to XS5 plug connectors (twist & click). For details on the twist & click locking mechanism refer to XS5 data sheet.

<sup>\*2</sup> For PUR models replace -F by -P in the order code

## Specifications

Rated current	4A
Rated voltage	125 VDC, 250 VAC
Degree of protection	IP67 (IEC 60529)
Ambient temperature	-25°C to 70°C

### Pin arrangement

#### M12 4 poles

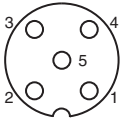

- 1 = brown
- 2 = white
- 3 = blue
- 4 = black
- 5 = n.c.

### Materials

Pin block	PBT resin (UL94V-0)
Contacts	Phosphor bronze/nickel base, 0.4 µm gold plating
Fixture	Zinc alloy/nickel plated
Cover	Polyester elastomer (UL94V-0)
O-ring	Rubber

## Dimensions

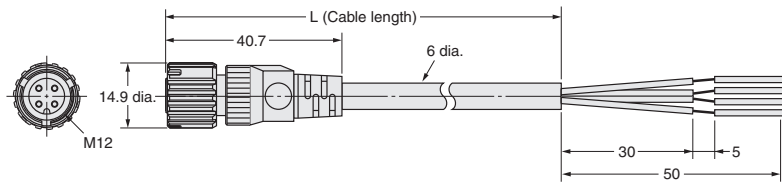

# XS2C/G, XS5C/G, Y92E-\_\_conf

## Ordering information

Type	Size	Material Nut	Features	Shape	Order code	
Plug (male)	M8	Polyester elastomer	3 pin	straight	Y92E-MM08PVC3Sconf-L	
			4 pin		Y92E-MM08PVC4Sconf-L	
	M12		4 pin	IDC	straight	XS5G-D418
				crimp		XS2G-D4C3
				solder		XS2G-D423
				solder		XS2G-D424
	M12		5 pin	screw fix	straight	XS2G-D5S1
					angled	XS2G-D5S2
4 pin twist & click (for 4-5 mm cables)		screw fix	straight	XS2G-D4S3		
			angled	XS2G-D4S4		
Connector (female)	M8	Polyester elastomer	3 pin	straight	Y92E-M08PVC3Sconf-L	
			4 pin		Y92E-M08PVC4Sconf-L	
	M12		4 pin	IDC	straight	XS5C-D418
				crimp		XS2C-D4C3
				solder		XS2C-D423
				crimp		XS2C-D4C4
	M12		5 pin	screw fix	straight	XS2C-D5S1
					angled	XS2C-D5S2

## Specifications

	Y92E	XS2C/G, XS5C/G
Rated current	4 A	
Rated voltage	36 VDC	125 VDC, 250 VAC
Degree of protection	IP67 (IEC60529)	
Ambient temperature	-25°C to 70°C	

## Pin arrangement

M8		M12			
Plug	Connectors	Plug		Connectors	
4 pin	4 pin	4 pin	5 pin	4 pin	5 pin
4 pin: 1 = brown 2 = white 3 = blue 4 = black			5 pin: 1 = brown 2 = white 3 = blue 4 = black 5 = green / yellow		

## Materials

	Y92E	XS2C/G, XS5C/G
Pin block	PVC	PBT resin (UL94V-0)
Contacts	CuSn, nickel base, 0.3 µm gold plating	Brass/nickel base, 0.4 µm gold plating
Fixture		Brass/nickel base
Cover	PVC	PBT resin (UL94V-0)
O-ring	FKM	Rubber



## Dimensions

### Plugs (male)

#### XS5G-D418 (IDC Model, Straight)

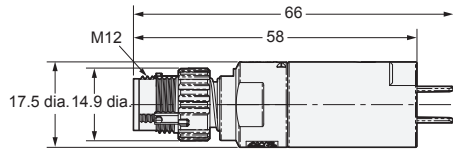

#### XS2G-D4C (Crimping Model, Straight), XS2G-D42 (Soldering Model, Straight)

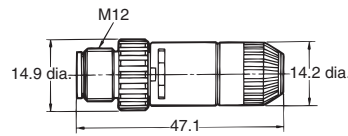
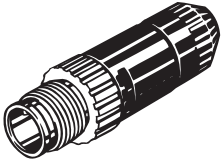

#### XS2G-D5S1 (Screw-on model, Straight)

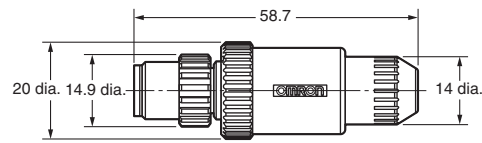
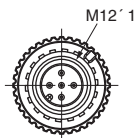

#### XS2G-D42 (Soldering Model, L-shaped)

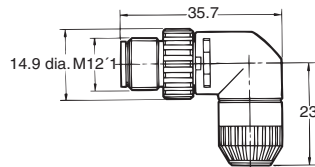
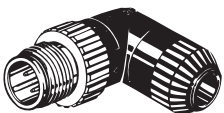

#### XS2G-D5S2 (Screw-on model, angled)

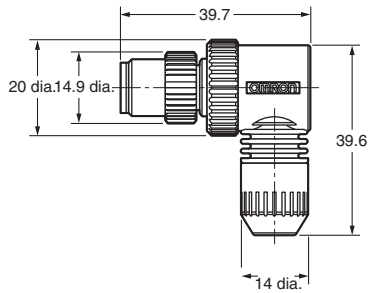
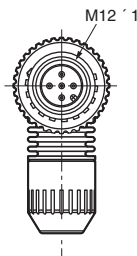
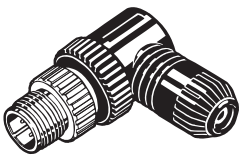

## Connectors (female)

### XS5C-D418 (IDC Model, Straight)

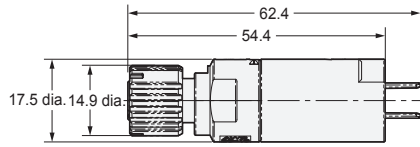
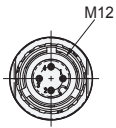

### XS2C-D4C□ (Crimping Model, Straight),

### XS2C-D42□ (Soldering Model, Straight)

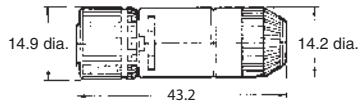
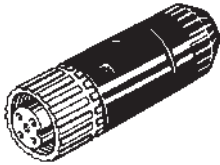

### XS2C-D5S1 (Screw-on model, straight)

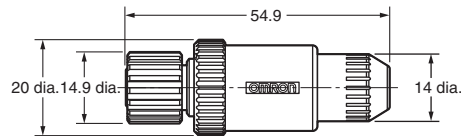
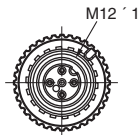

### XS2C-D4C□ (Crimping Model, L-shaped)

### XS2C-D42□ (Soldering Model, L-shaped)

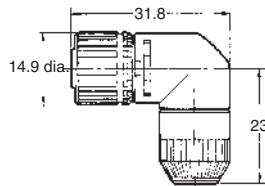
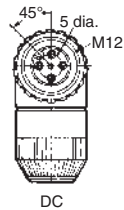
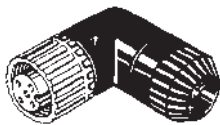

### XS2C-D5S2 (Screw-on model, angled)

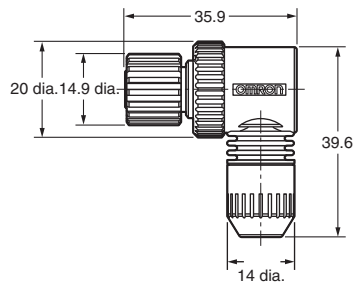
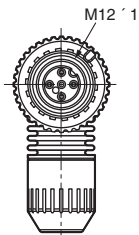
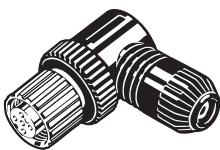

# XW3B, XW3D, DRT2

## Ordering information

Type	Nr of inputs/ outputs	Output configuration	Connection	Order code
Direct wiring	4 x M12 inputs	PNP <sup>*1</sup>	5m pre-wired	XW3B-P453-G11
	6 x M12 inputs			XW3B-P653-G11
	8 x M12 inputs			XW3B-P853-G11
Direct wiring with M12 Twist&click	4 x M12 with smartclick inputs	PNP <sup>*1</sup>	5m pre-wired	XW3D-P453-G11 <sup>*2</sup>
	8 x M12 with smartclick inputs			XW3D-P853-G11 <sup>*2</sup>
DeviceNet	4 x M12 inputs	PNP <sup>*1</sup>	M12 (M12 DeviceNet cables are available)	DRT2-ID04CL-1
	8 x M12 inputs			DRT2-ID08CL-1 <sup>*3</sup>
	16 x M12 inputs			DRT2-HD16CL-1 <sup>*3</sup>
	8 x M12 inputs + 8 x M12 outputs			DRT2-MD16CL-1

<sup>\*1</sup> NPN types are available on request

<sup>\*2</sup> For details refer to Omron XS5 product information

<sup>\*3</sup> Separate power supply. Models with power supply via DeviceNet cable are available

## Specifications

	XW3B/XW3D	DRT2
<b>Rated current</b>	4 A/port (signal lines) 12 A/box (power lines)	6 mA input 0.5 A per point (output)
<b>Rated voltage</b>	10 to 30 VDC	24 VDC
<b>Degree of protection</b>	IP67 (IEC 60529)	
<b>Operating temperature</b>	-25°C to 70°C	-10°C to 55°C

Note: For details and dimensions refer to separate datasheet or [industrial.omron.eu](http://industrial.omron.eu)

# E3X-CN

## Ordering information

Type	Size	Features	Order code
Fiber amplifier connector	Special connector 17,8x10x15,1	4 wire; 2 m PVC cable	E3X-CN21
		3 wire; 2 m PVC cable	E3X-CN11
		2 wire slave cable; 2 m PVC	E3X-CN22 <sup>*1</sup>
		1 wire slave cable; 2 m PVC	E3X-CN12 <sup>*1</sup>
		M8 4-pin plug with 30 cm PVC cable	E3X-CN21-M3J-2 0.3M
		M12 4-pin plug with 30 cm PVC cable	E3X-CN21-M1J 0.3M

<sup>\*1</sup> Slave connectors can be used to reduce wiring effort. The setup requires 1 master amplifier with the slave amplifiers directly mounted attached. The power supply is then provided by the master amplifier via the clipped on slave connectors. For 4-wire masters use 2-wire slaves and for 3-wire masters 1-wire slaves.

## Specifications

Rated current	2.5 A
Rated voltage	50V
Degree of protection	IP50 (EC 60529)
Ambient temperature	Groups of 1 or 2 amplifiers: -25 to 55°C
	Groups of 3 to 10 amplifiers: -25 to 50°C
	Groups of 11 to 16 amplifiers: -25 to 45°C

## Materials

Housing	Polybutylene terephthalate (PBT)
Contacts	Phosphor bronze/ gold plated/ nickel

## Pin arrangement

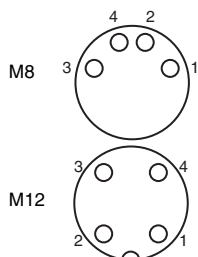

Connector	Cable colour	
1	brown	+
2	orange/white	Output 2 or ext. input
3	blue	-
4	black	Output 1
	pink	Ext. Input

Dimensions

Master connectors  
E3X-CN21/E3X-CN11

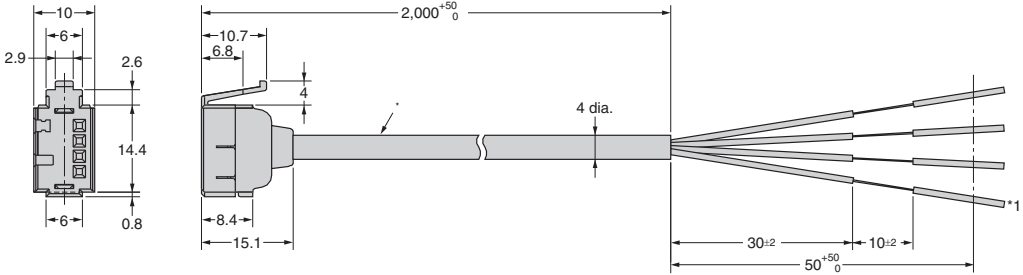

\* E3X-CN21: 4-dia. vinyl-insulated round cable with 4 conductors (Conductor cross section: 0.2 mm<sup>2</sup>, Insulator diameter: 1.1 mm)

\*1 Only E3X-CN21

Slave connectors  
E3X-CN22/E3X-CN12

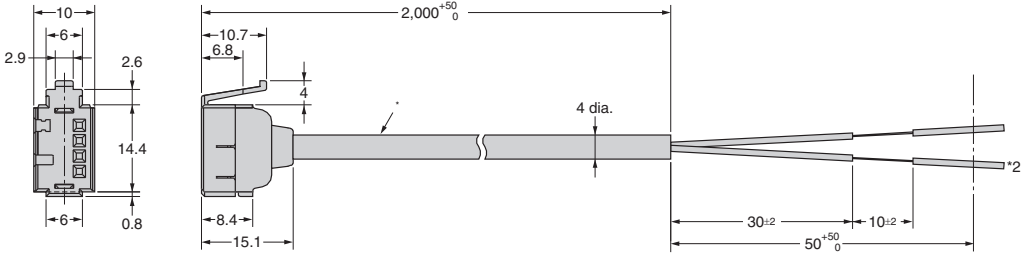

\* E3X-CN21: 4-dia. vinyl-insulated round cable with 4 conductors (Conductor cross section: 0.2 mm<sup>2</sup>, Insulator diameter: 1.1 mm)

\*2 Only E3X-CN22

## Ordering information

Type	Size	Features	Applicable sensors	Order code
Pin connector for soldering	13x4x10.8	For dark on	EE-SX47/67	EE-1001
		For light on		EE-1001-1
Cable connector	13x4x13.5	standard cable		EE-1010 2M
		robotic cable		EE-1010-R 2M
	10x5.8x8	standard cable	EE-1017 1M	
		robotic cable	EE-1017-R 1M	
Cable connector for EE-SX91 pigtail versions	10x5.8x8	robotic cable	EE-SX91	EE-1016-R

## Specifications

Rated voltage	5 to 24 VDC
Degree of protection	IP50 (IEC 60529)
Ambient temperature range	operating: -25 to 55°C
	storage: -30 to 80°C

## Material

	EE-1001	EE-1010/EE-1016	EE-1017
Housing	Nylon		
Contacts	Phosphor bronze		
Cable	-	PVC 2 m	PVC 1 m (3 m are available on request)

## Pin arrangement

	EE-1001, EE-1010		EE-1016		EE-1017	
1	+	Brown	+	Brown	+	Brown
2	L	Pink	output 2	White	1	Black
3	out	Black	-	Blue	2	White
4	-	Blue	output 1	Black	-	Blue

Note: For the connector EE-1001-1 the pins 1(+) and 2 (L) are short circuited

Dimensions

Connector  
EE-1001

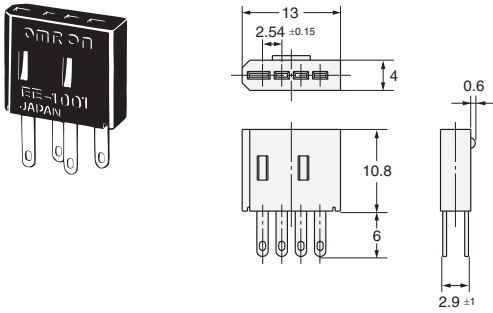

Connector  
(short-circuited between positive (+) and L terminals)  
EE-1001-1

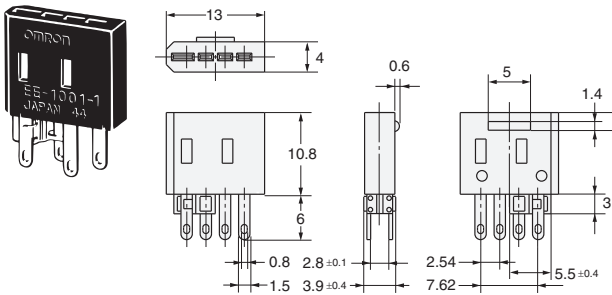

Connector with Cable  
EE-1010

Connector with Robot Cable  
EE-1010-R

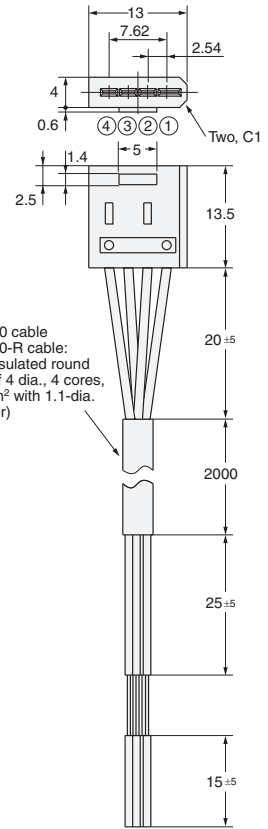

Connector with Robot Cable  
EE-1016-R

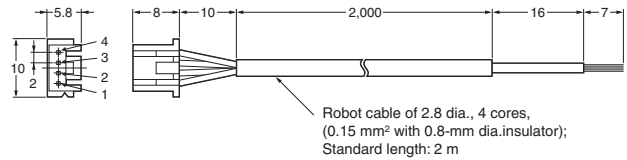

Connector with Robot Cable  
EE-1017-R

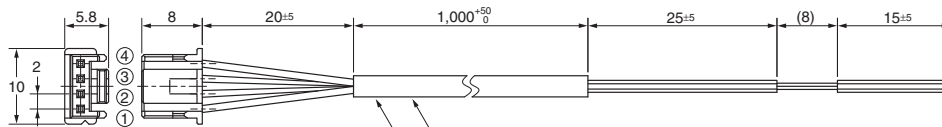

Connector with Cable: EE-1017  
Vinyl insulated round cord: 4 dia., 4 cores,  
(Cross section area of conductor: 0.2 mm<sup>2</sup>/ insulator: 1.1 mm dia.)

Connector with Robot Cable: EE-1017-R  
Robot instrumentation cord: 4 dia., 4 cores,  
(Cross section area of conductor: 0.2 mm<sup>2</sup>/ insulator: 1.1 mm dia.)

# XS2

Name	Model		Appearance
Cable connectors with plugs (open end or connector end)	XS2W Plug connectors (Connector end)		
	XS2H Plug connectors (Open end)		
Connector Assembly Accessories (Crimping, Soldering, or Screw-on)	XS2F Crimp Tool (for Crimping Connectors)		
	XS2U Crimping pin (for XS2G/XS2C)		
	XW4Z Screwdriver (for Screw-on Connectors)		
Panel-mounting Connectors	XS2P Sockets (M12) XS3P Sockets (M8)		
	XS2M Plugs (M12) XS3M Plugs (M8)	Flange-mounting Plugs	
		Screw-mounting Plugs	
T-Joints and Y-Joints Used for branching and for daisy-chain connections.	XS2R T-Joint/Y-Joint Plug/Socket Connectors (M12) XS3R Y-Joint Plug/Socket Connectors (M8)		
Dust covers Used to protect unused connector ports	XS2Z (M12) XS3Z (M8)		

Note: For details on these products, contact your Omron representative





## Read and Understand This Catalog

Please read and understand this catalog before purchasing the products. Please consult your OMRON representative if you have any questions or comments.

## Warranty and Limitations of Liability

### WARRANTY

OMRON's exclusive warranty is that the products are free from defects in materials and workmanship for a period of one year (or other period if specified) from date of sale by OMRON.

OMRON MAKES NO WARRANTY OR REPRESENTATION, EXPRESS OR IMPLIED, REGARDING NON-INFRINGEMENT, MERCHANTABILITY, OR FITNESS FOR PARTICULAR PURPOSE OF THE PRODUCTS. ANY BUYER OR USER ACKNOWLEDGES THAT THE BUYER OR USER ALONE HAS DETERMINED THAT THE PRODUCTS WILL SUITABLY MEET THE REQUIREMENTS OF THEIR INTENDED USE. OMRON DISCLAIMS ALL OTHER WARRANTIES, EXPRESS OR IMPLIED.

### LIMITATIONS OF LIABILITY

OMRON SHALL NOT BE RESPONSIBLE FOR SPECIAL, INDIRECT, OR CONSEQUENTIAL DAMAGES, LOSS OF PROFITS OR COMMERCIAL LOSS IN ANY WAY CONNECTED WITH THE PRODUCTS, WHETHER SUCH CLAIM IS BASED ON CONTRACT, WARRANTY, NEGLIGENCE, OR STRICT LIABILITY.

In no event shall the responsibility of OMRON for any act exceed the individual price of the product on which liability is asserted.

IN NO EVENT SHALL OMRON BE RESPONSIBLE FOR WARRANTY, REPAIR, OR OTHER CLAIMS REGARDING THE PRODUCTS UNLESS OMRON'S ANALYSIS CONFIRMS THAT THE PRODUCTS WERE PROPERLY HANDLED, STORED, INSTALLED, AND MAINTAINED AND NOT SUBJECT TO CONTAMINATION, ABUSE, MISUSE, OR INAPPROPRIATE MODIFICATION OR REPAIR.

## Application Considerations

### SUITABILITY FOR USE

OMRON shall not be responsible for conformity with any standards, codes, or regulations that apply to the combination of products in the customer's application or use of the products.

At the customer's request, OMRON will provide applicable third party certification documents identifying ratings and limitations of use that apply to the products. This information by itself is not sufficient for a complete determination of the suitability of the products in combination with the end product, machine, system, or other application or use.

The following are some examples of applications for which particular attention must be given. This is not intended to be an exhaustive list of all possible uses of the products, nor is it intended to imply that the uses listed may be suitable for the products:

- Outdoor use, uses involving potential chemical contamination or electrical interference, or conditions or uses not described in this catalog.
- Nuclear energy control systems, combustion systems, railroad systems, aviation systems, medical equipment, amusement machines, vehicles, safety equipment, and installations subject to separate industry or government regulations.
- Systems, machines, and equipment that could present a risk to life or property.

Please know and observe all prohibitions of use applicable to the products.

NEVER USE THE PRODUCTS FOR AN APPLICATION INVOLVING SERIOUS RISK TO LIFE OR PROPERTY WITHOUT ENSURING THAT THE SYSTEM AS A WHOLE HAS BEEN DESIGNED TO ADDRESS THE RISKS, AND THAT THE OMRON PRODUCTS ARE PROPERLY RATED AND INSTALLED FOR THE INTENDED USE WITHIN THE OVERALL EQUIPMENT OR SYSTEM.

### PROGRAMMABLE PRODUCTS

OMRON shall not be responsible for the user's programming of a programmable product, or any consequence thereof.

## Disclaimers

### CHANGE IN SPECIFICATIONS

Product specifications and accessories may be changed at any time based on improvements and other reasons.

It is our practice to change model numbers when published ratings or features are changed, or when significant construction changes are made. However, some specifications of the products may be changed without any notice. When in doubt, special model numbers may be assigned to fix or establish key specifications for your application on your request. Please consult with your OMRON representative at any time to confirm actual specifications of purchased products.

### DIMENSIONS AND WEIGHTS

Dimensions and weights are nominal and are not to be used for manufacturing purposes, even when tolerances are shown.

### PERFORMANCE DATA

Performance data given in this catalog is provided as a guide for the user in determining suitability and does not constitute a warranty. It may represent the result of OMRON's test conditions, and the users must correlate it to actual application requirements. Actual performance is subject to the OMRON Warranty and Limitations of Liability.

### ERRORS AND OMISSIONS

The information in this document has been carefully checked and is believed to be accurate; however, no responsibility is assumed for clerical, typographical, or proofreading errors, or omissions.

Cat. No. E96E-EN-03

**In the interest of product improvement, specifications are subject to change without notice.**

## OMRON EUROPE B.V.

Wegalaan 67-69,  
NL-2132 JD, Hoofddorp,  
The Netherlands  
Phone: +31 23 568 13 00  
Fax: +31 23 568 13 88  
industrial.omron.eu