

CJ1W-CLK23

New Controller Link Units, Now with 4,000 Send Words

- The Controller Link is an FA network that can send and receive large amounts of data easily and at high speed. The Controller Link supports data links that enable sharing data between PLCs and computers and a message service that enables sending and receiving data whenever required.
- Systems can be flexibly built by using Repeater Units to enable T-branches, long-distance wiring, and converting part of the network to optical cable.



CJ1W-CLK23 **NEW**

Features

- Large-capacity data links are easily achieved without programming simply by setting data link tables.
- Up to 20,000(See note 1.) send/receive words can be set per node for Units (up to 62,000 words for Boards).
- Data links can be performed with up to 4,000(See note 2.) words per node while ensuring data concurrency.
- User-set data link tables can be changed while data links are operating.(See note 3.)
- Errors for the entire system can be monitored by using error diagnosis support software and a variety of status flags.

Note:

1. Supported for unit version 1.2 or later.
2. CJ1W-CLK23 and 3G8F7-CLK□3 are supported.
3. Supported for CJ1W-CLK23, 3G8F7-CLK□3, and models ending with “-V1”.

System Configuration

■ Wired Controller Link Units

Basic Wiring (Daisy Chain Connection)

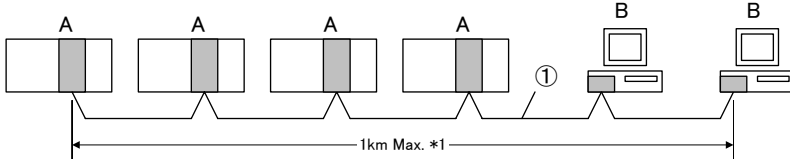

Long-distance Wiring

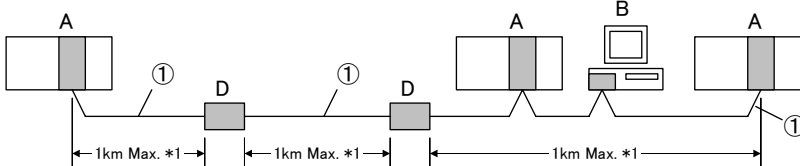

- A: Wired Controller Link Unit
- B: Wired Controller Link Support Board
- C: Wire-to-Optical Repeater Unit
- D: Wire-to-Wire Repeater Unit
- *1: At 500 kbits/s

- ①: Twisted-pair cable
- ②: Optical cable

T-Branch Wiring, Partial Conversion to Optical Cable

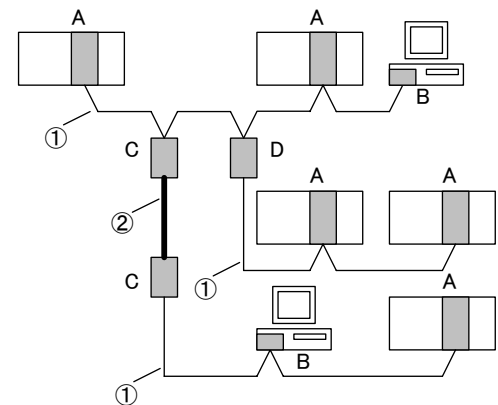

Ordering Information

● Controller Link Units, New Models

Unit classification	Product name	Specifications				No. of unit numbers allocated	Current consumption (A)		Model	Standards
		Communications cable	Communications type	Duplex support	Max. Units mountable per CPU Unit		5V DC	24 V DC		
CJ1 CPU Bus Unit	Controller Link Unit 	Wired shielded twisted-pair cable (See note.)	Data links and message service	No	8	1	0.33	—	CJ1W-CLK23 NEW	UC1, N.L., CE

● Controller Link Units, Old Models

Unit classification	Product name	Specifications				No. of unit numbers allocated	Current consumption (A)		Model Note: New models are listed above.	Standards
		Communications cable	Communications type	Duplex support	Max. Units mountable per CPU Unit		5V DC	24 V DC		
CJ1 CPU Bus Unit	Controller Link Unit	Wired shielded twisted-pair cable (See note.)	Data links and message service	No	8	1	0.33	—	CJ1W-CLK21-V1	UC1, N.L., CE

New models are fully compatible with old models and provide enhanced functionality, such as an increase in the number of send words from 1,000 to 4,000 words. Select a new model when ordering.

Note: Use the following special cable for shielded, twisted-pair cable.

- ESVC0.5×2C-13262 (Bando Electric Wire : Japanese Company)
- ESNCO.5×2C-99-087B (Nihon Electric Wire & Cable Corporation : Japanese Company)
- Li2Y-FCY2×0.56qmm (Kromberg & Schubert, Komtec Department : German Company)
- 1×2×AWG-20PE+Tr.CUSN+PVC (Draka Cables Industrial : Spanish Company)
- #9207 (Belden : US Company)

● Controller Link Support Boards, New Models

Product name	Specifications		Accessories	Model	Standards
	Communications cable	Communications type			
Controller Link Support Board for PCI Bus 	Wired shielded twisted-pair cable	Data links and message service	Communications Middleware FinsGateway Version 2003 and Version 3 are supplied.	3G8F7-CLK23-E NEW	CE

● Controller Link Support Boards, Old Models

Product name	Specifications		Accessories	Model Note: New models are listed above.	Standards
	Communications cable	Communications type			
Controller Link Support Board for PCI Bus	Wired shielded twisted-pair cable	Data links and message service	Communications Middleware FinsGateway Version 2003 and Version 3 are supplied.	3G8F7-CLK21-EV1	CE

New models are fully compatible with old models and provide enhanced functionality, such as an increase in the number of send words from 1,000 to 4,000 words. Select a new model when ordering.

● Repeater Units

Name	Specifications	Model	Standards
 Controller Link Repeater Unit	Wire-to-Wire Model	CS1W-RPT01	UC1,CE
	Wire-to-Optical (H-PCF) Model (See note 1.)	CS1W-RPT02	
	Wire-to-Optical (GI) Model (See note 2.)	CS1W-RPT03	

Using Repeater Units enables T-branches and long-distance wiring for Wired Controller Link networks, 62-node configurations, and converting part of the network to optical cable.

Note:



1. When using wire-to-optical (H-PCF) cable, use a H-PCF cable (for both Controller Link and SYSMAC LINK) or a H-PCF optical fiber cable with connector.
2. When using wire-to-optical (GI) cable, use a GI optical cable (for Controller Link).

● Relay Terminal Block

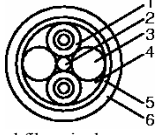

Name	Specifications	Model	Standards
 Relay Terminal Block for Wired Controller Link Units	Used for Wired Controller Link Units (set of 5)	CJ1W-TB101	—

Controller Link Units can be replaced without stopping the communications of the entire network if a Relay Terminal Block is installed in advance on the Unit in a Wired Controller Link network. Relay Terminal Blocks cannot be used on Controller Link Support Boards.

● H-PCF Cables and Optical Connectors

Name	Application/construction	Specifications	Model	Standards	
Optical Fiber Cables	 1. Optical fiber single-core cord 2. Tension member (plastic-sheathed wire) 3. Filler (plastic) 4. Filler surrounding signal wires (plastic, yarn, or fiber) 5. Holding tape (plastic) 6. Heat-resistant PV sheath	Two-core optical cable with tension member	Black 10 m	S3200-HCCB101	—
			Black 50 m	S3200-HCCB501	
			Black 100 m	S3200-HCCB102	
			Black 500 m	S3200-HCCB502	
			Black 1000 m	S3200-HCCB103	
			Orange 10 m	S3200-HCCO101	
			Orange 50 m	S3200-HCCO501	
			Orange 100 m	S3200-HCCO102	
			Orange 500 m	S3200-HCCO502	
			Orange 1000 m	S3200-HCCO103	
Optical Connectors (Crimp-cut)	  CS1W-RPT02	Half lock	S3200-COCF2571	—	
		Full lock	S3200-COCF2071		

● H-PCF Optical Fiber Cables with Connectors (Black Composite Cables with Two-Optical Lines and Two Power Supply Lines)

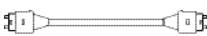
Application	Appearance	Model	Standards
Controller Link, SYSMAC LINK		S3200-CN□□□□-20-20	—
		S3200-CN□□□□-20-25	
		S3200-CN□□□□-25-25	

Optical connectors for H-PCF Optical Cables with Connectors are adhesive polished.

• Cable Length

The following cable lengths are available: 2 m, 5 m, 15 m, 20 m. For lengths of 21 m or more, contact your OMRON sales representative.

•Model Numbers

(1) 2 m, 5 m, 10 m, 15 m, or 20 m

(2) 21 m or longer

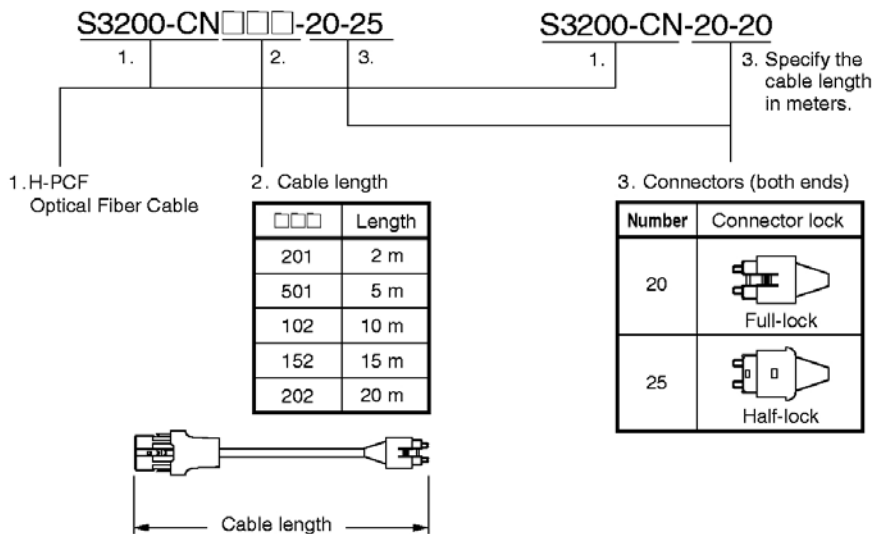

•Optical Connector Assembly Tool

Name	Applicable Unit	Model	Manufacturer	Standards
Optical Fiber Assembly Tool (See note.)	This tool is used on site for mounting crimp-cut connectors and hard plastic-clad silica optical fiber for optical transmission systems of SYSMAC C-series SYSBUS, SYSMAC LINK, and Controller Link.	CAK-0057	Sumitomo Electric Industries, Ltd.	—

Note: There is a risk of quality problems when using cables assembled by typical users, so we recommend purchasing cables with preattached connectors or having a qualified technician assemble the cables.

●GI Optical Cables

A qualified technician must select, assemble, and install GI Optical Fiber Cable, so always let an optical cable specialist handle the GI cable.

Usable Optical Cables and Optical Connectors

- Optical fiber types: Graded, indexed, multi-mode, all quartz glass, fiber (GI-type AGF cable)
- Optical fiber construction (core diameter/clad diameter): 62.5/125 μm or 50/125 μm
- Optical fiber optical characteristics of optical fiber: Refer to the tables.
- Optical connector: ST connector (IEC-874-10)

•50/125 μm AGF Cable

Item	Minimum	Standard	Maximum	Conditions	
Numerical Aperture (N.A)	—	0.21	—	—	
Transmission loss (dB)	—	—	3.0Lf	0.5 km ≤ Lf	λ = 0.8 μm Ta=25°C
			3.0Lf+0.2	0.2 km ≤ Lf ≤ 0.5 km	
			3.0Lf+0.4	Lf ≤ 0.2 km	
Connection loss (dB)	—	—	1.0	λ = 0.8 μm, one location	
Transmission bandwidth (MHz-km)	500	—	—	λ = 0.85 μm (LD)	

Lf is fiber length in km, Ta is ambient temperature, and λ is the peak wavelength of the test light source.

•62.5/125 μm AGF Cable

Item	Minimum	Standard	Maximum	Conditions	
Numerical Aperture (N.A)	—	0.28	—	—	
Transmission loss (dB)	—	—	3.5Lf	0.5 km ≤ Lf	λ = 0.8 μm Ta=25°C
			3.5Lf+0.2	0.2 km ≤ Lf ≤ 0.5 km	
			3.5Lf+0.4	Lf ≤ 0.2 km	
Connection loss (dB)	—	—	1.0	λ = 0.8 μm, one location	
Transmission bandwidth (MHz-km)	200	—	—	λ = 0.85 μm (LD)	

Lf is fiber length in km, Ta is ambient temperature, and λ is the peak wavelength of the test light source.

●International Standards

- The standards indicated in the “Standards” column are those current for UL, CSA, cULus, cUL, NK, and Lloyd standards and EC Directives as of the end of July 2007. (The standards are abbreviated as follows: U: UL, U1: UL Class I Division 2 Products for Hazardous Locations, C: CSA, US: cULus Class I Division 2 Products for Hazardous Locations, CU: cUL, N: NK, L: Lloyd, and CE: EC Directives.)
- Ask your OMRON representatives for the conditions under which the standards were met.

Mountable Racks

■ Mountable Racks for CJ-series Controller Link Units

Model		CJ1 System		CP1H System	NSJ System	
		CPU Rack	Expansion Backplane	CP1H PLC	NSJ Controller	Expansion Backplane
CJ1W-CLK23	Unit version 2.0	8 Units (per CPU Unit)		2 Units (See note 1.)	Not supported (See note 2.)	8 Units (See note 3.)
CJ1W-CLK21-V1	Unit version 1.2					

Note:

1. A CP1W-EXT01 CJ Unit Adaptor is required.
2. One NSJW-CLK21-V1 can be mounted to the NSJ Controller.
3. If an Expansion Rack is used, the NSJW-CLK21-V1 cannot be mounted to the NSJ Controller.

Communications Specifications

Items	Specifications
Model	CJ1W-CLK23 3G8F7-CLK23-E CJ1W-CLK21-V1 3G8F7-CLK21-EV1
Type	Wired (shielded twisted-pair cable)
Communications method	N:N token-bus method
Code	Manchester code
Modulation	Baseband code
Synchronization	Flag synchronization (conforms to HDLC frames)
Transmission path format	Multidrop method (bus type)
Transmission speed	The following are the maximum transmission distances depending on the transmission speed.
Maximum transmission distance	2 Mbits/s: 500 m 1 Mbits/s: 800 m 500 kbits/s: 1 km
Maximum distance between nodes	Not specified. (Maximum transmission distance must be satisfied for the entire system.)
Medium	Specified shielded twist-pair cable Two signal wires, one shield
Node connection method	PLC: Connection to terminal block Computer: Connection using special (supplied) connector
Maximum number of nodes	32 or 62 nodes (See note 1 and 2.)
Applicable Programming Devices	CX-Integrator in CX-One, CX-Net in CX-Programmer (See note 2.), and Programming Console
Communications functions	Data links and message service
Number of data link words	Send words per node: 4,000 words max. (CJ1W-CLK□3), 1,000 words max. (All other Units) Number of send/receive words per node: 12,000 words max. (CS Pre-Ver. 1.2) 20,000 words max. (CS unit Ver. 1.2 or later) Total number of send words per network: 62,000 words max.
Data link areas	PLC: Bit areas (CIO Area, Work Area, Link Area (See note 3.)), Data Memory (DM), Extended DM Area (EM) Computer: FinsGateway event memory
Message length	2,012 bytes max. (including the header)
RAS functions	<ul style="list-style-type: none"> • Polling node backup function • Self-diagnosis function (hardware checking at startup) • Echoback test and broadcast test (using the FINS command) • Watchdog timer • Error log function
Error control	Manchester code check CRC check (CCITT $X^{16}+X^{12}+X^5+1$)

Note:

1. With wired models, the maximum number of nodes is 32 if Repeater Units are not used. A Repeater Unit is required when building a network with more than 32 nodes. If a Repeater Unit is used, be sure to use only the following Controller Link Units or Boards and set the Wired Network 62 Node Enable Bit in the DM Parameter Area software switches at all nodes.
CS1W-CLK23/CLK21-V1
CJ1W-CLK23/CLK21-V1
3G8F7-CLK23-E/CLK21-EV1
2. CX-Net in CX-Programmer version 3.1 or earlier can be used only in a system with a maximum of 32 nodes (node address 1 to 32). If a system is to be used with a maximum of 62 nodes (node addresses 1 to 62), use CX-Net in CX-Programmer version 3.2 or higher or the CX-Integrator.
3. CJ-series PLCs do not have a Link Area, but LR000 to LR199 are automatically converted CIO 1000 to CIO 1199.

Individual Specifications

■ Controller Link Units

Item	Specifications
Model	CJ1W-CLK23 CJ1W-CLK21-V1
Applicable PLC	All CJ-series CPU Units
Number of mountable Units	8 max.
Installation site	Install onto a CPU Backplane or Expansion Backplane (classified as a CPU Bus Unit).
Storage location of network parameters and manually set data link tables	System Bus Unit Area (in the CPU Unit parameter area).
Storage location of routing tables	CPU Unit parameter area
Weight	110 g
Current consumption: 5 V in PLC	0.35 A

■ Controller Link Support Boards (for PCI Bus)

Item	Specifications		
Model	3G8F7-CLK23-E 3G8F7-CLK21-EV1	3G8F7-CLK13-E 3G8F7-CLK12-EV1	3G8F7-CLK53-E 3G8F7-CLK52-EV1
Computer-compatible models	IBM PC/AT or compatible <ul style="list-style-type: none"> • CPU: Intel Celeron 400 MHz or better • Main memory: 128 MB minimum • One or more PCI bus slots (PCI bus revision 2.0 or later, power supply: 5 V) • Free hard disk space: 70 MB min. • CD-ROM drive: One required for installation • Display: VGA (640 x 480 (pixels) min.) (Other conditions conform to the OS.)		
Compatible OS	<ul style="list-style-type: none"> • FinsGateway Version2003 <ul style="list-style-type: none"> WindowsXP Professional WindowsXP Home Edition Windows2000 Professional • FinsGateway Version3 <ul style="list-style-type: none"> WindowsXP Professional WindowsXP Home Edition Windows2000 Professional WindowsNT4.0 (Service Pack 3 or higher) WindowsME Windows98SE 		
Weight	104 g	120 g (excluding mounting bracket)	124 g (excluding mounting bracket)
Current consumption	5 V in PLC	0.35 A	0.54 A
	External 24 V	—	0.35 A

Install FinsGateway version 3 if the operating system is Windows NT 4.0 (Service pack 3 or higher), Windows ME, or Windows 98SE. In that case, however, the new functions of Controller Link Support Boards for the PCI Bus cannot be used (i.e., automatic data link creation with 1:N allocation, changing data link tables with active data links, 62-node setting for wired models, and maximum of 4000 send words).

■ Repeater Units

Item	Specifications		
Model	CS1W-RPT01	CS1W-RPT02	CS1W-RPT03
Supported Units/Boards	All wired Controller Link Units and Boards Note: If a maximum of 62 nodes is used, models that support 62 nodes must be used.		
Transmission line	Wire-to-wire	Wire-to-optical (H-PCF)	Wire-to-optical (GI)
Transmission line format	Multi-drop Tree	1:1 type	1:1 type
Installation	Repeater Units are not mounted to the PLC. They are mounted separately with screws or on a DIN Track.		
Weight	126 g	113 g (excluding mounting bracket)	116 g (excluding mounting bracket)
Allowable power supply voltage range	20.4 to 26.4 V DC (24 V DC -15 to 10%)		
Current consumption	24 V DC at 0.06 A	24 V DC at 0.06 A	24 V DC at 0.06 A
Inrush current	2.5 A max. at 24 V DC (5 ms after startup)		

Repeater Units are used to expand the Controller Link network for wired models. For Wired-to-optical Repeater Units, always use a set of two (1:1). Optical Ring Controller Link Units and Boards cannot be connected to the optical cable section between Repeater Units.

External Interface

■ CJ1W-CLK23/CJ1W-CLK21-V1

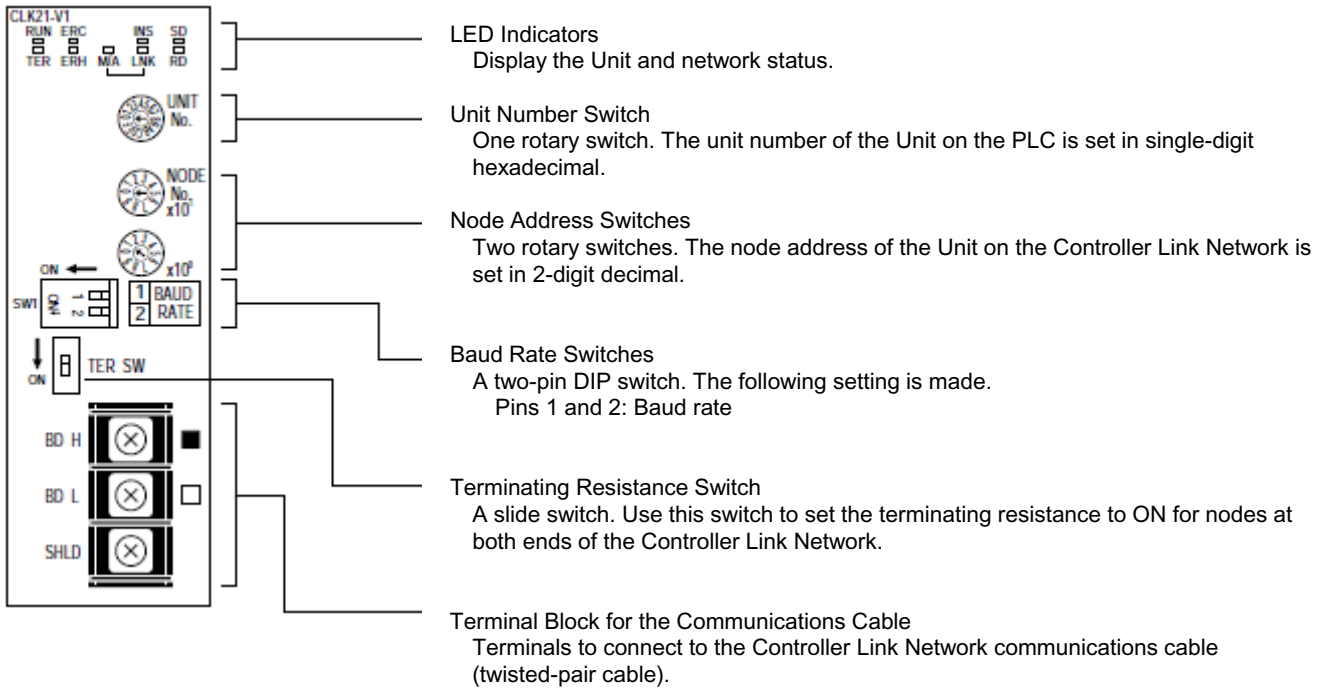

Definition of Terminal Block Pin Names for Communications Cables

Marking	Notation	Signal name	Line color
■	BD H	Communication data, high	Black
□	BD L	Communication data, low	White
None	SHLD	Shield	None

Differences in Specifications of New and Old Models

The following table shows the main differences in specifications between the new and old models.

Functions	CJ1W-CLK23	CJ1W-CLK21-V1	Note: The following models are discontinued. CJ1W-CLK21-V1	Note: The following models are discontinued. CJ1W-CLK21
	Unit version 2.0	Unit version 1.2	Pre-Ver. 1.2	Pre-Ver. 1.2
Number of data link send words (data link areas that are created for a single node in a single PLC)	20,000 max.		12,000 max.	
Number of send words per node (total of area 1 and area 2)	4,000 words max. (user-set links only)	1,000 words max.		
Data Link Area	Allocation setting can be performed for same areas in areas 1 and 2.		Allocation setting can be performed for same areas in areas 1 and 2.	
Max. Units mountable per PLC	8 Units		4 Units	
Automatic data link setting	Choose from equality layout or 1:N allocations (common type, 1:1, chain type)			Supported for equality layout only.
Changing data link allocations during active data links	Supported (Data link tables can be changed during active data links.)			Not supported.
Maximum connectable nodes	62 nodes (See note 1.)			32 nodes
Mixed use	Yes (See note 2.)			
Compatible support software	CX-Integrator for CX-One V2.1 or higher, or CX-Net for CX-Programmer Ver. 7.2 or higher	CX-Net for CX-Programmer Ver. 5.0 or higher	CX-Net for CX-Programmer Ver. 3.2 or higher	CX-Net for CX-Programmer Ver. 1.0 or higher

Note:

- For wired models, the maximum number of nodes is 32 if Repeater Units are not used.
- Old models and new models can be used mixed on the same network. In that case, however, build the system using the specifications for the old models. The data link send/receive words can be separately set to their maximums when new and old models are mixed.

The following table shows the main differences in specifications between the new and old models of Controller Link Support Boards.

Functions	3G8F7-CLK23-E	3G8F7-CLK21-EV1	Note: The following models are discontinued. 3G8F7-CLK21-E
	Number of data link send/receive words (data link areas for sending/receiving that are created for a single node in a single computer)	62,000 max.	
Send words per node	4,000 words max. (user-set links only)	1,000 words max.	
Changing data link allocations during active data links	Supported. (Data link tables can be changed during active data links.)		Not supported.
Maximum connectable nodes	62 nodes (See note 1.)		32 nodes
Mixed use	Yes (See note 2.)		
Compatible FinsGateway and version of supplied CD (See note 3.)	FinsGateway Version 2003.21 or higher (CD Ver. 3.00 or higher)	FinsGateway Version 2003.00 or higher (CD Ver. 2.00 or higher)	FinsGateway Version 3.00 or higher (CD Ver. 1.00 or higher)
Compatible support software	CX-Integrator for CX-One Ver. 2.1 or higher, or CX-Net for CX-Programmer Ver. 7.2 or higher	CX-Net for CX-Programmer Ver. 3.2 or higher	CX-Net for Ver. 1.0 or higher

Note:

- For wired models, the maximum number of nodes is 32 if repeater units are not used.
- Old models and new models can be used mixed on the same network. In that case, however, build the system using the specifications for the old models. The data link send/receive words can be separately set to their maximums when new and old models are mixed.
- FinsGateway Version 2003 is compatible with Windows XP and Windows 2000. For Windows NT4.0 (Service Pack 3 or higher), Windows ME, or Windows 98SE, use FinsGateway Version3. (With FinsGateway Version 3, only functions supported by the 3G8F7-CLK21 can be used.)

Usage Precautions

- Old models and new models can be used mixed on the same network. In that case, however, build the system using the specifications for the old models. The data link send/receive words can be separately set to their maximums when new and old models are mixed.
- Repeater Units can be used to expand a Wired Controller Link Network. For Wired-to-optical Repeater Units, always use a set of two (1:1). Optical Ring Controller Link Units and Boards cannot be connected to the optical cable section between Repeater Units.
- Connect Repeater Units so that there are no more than two stages between any two nodes. One set of two Wire-to-Optical Repeater Units is counted as one stage.

Dimensions

(Unit: mm)

■ CJ1W-CLK23/ CJ1W-CLK21-V1

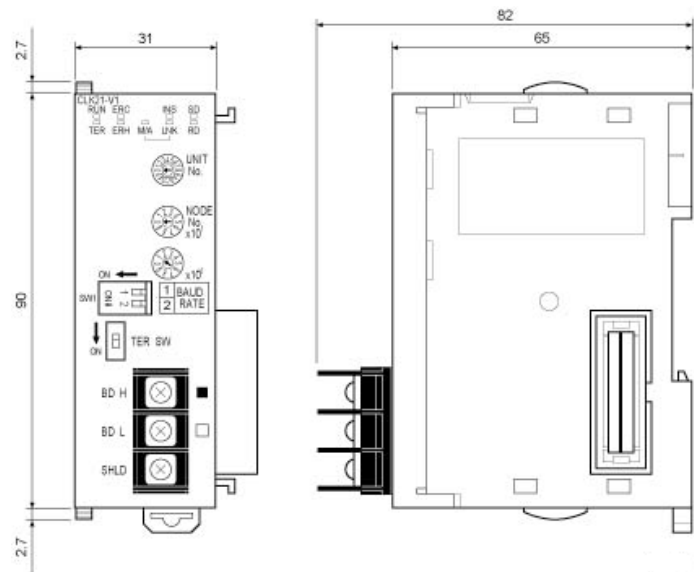

Related Manuals

The CJ-series Controller Link Unit related manuals are organized as shown in the chart below.

Cat.No	Model	Name	Applications	Description
W309	CS1W-CLK23 CS1W-CLK21-V1 CJ1W-CLK23 CJ1W-CLK21-V1 C200HW-CLK21 CVM1-CLK21 CQM1H-CLK21 CS1W-RPT01/02/03	Controller Link Units Operation Manual	Used when information regarding operating procedures for Wired Controller Link Units is needed.	Describes operating procedures for Controller Link Units. Controller Link Units can connect to Wired Controller Link Units.
W422	3G8F7-CLK12-V1 3G8F7-CLK52-V1 3G8F7-CLK21-V1	Controller Link Support Boards for PCI Bus Installation Guide (3G8F7-CLK12/21/52-V1)	Used when information regarding setup procedures for Controller Link Support Boards for PCI bus connections is needed.	Describes the setup method for the Controller Link Support Boards for PCI bus connections.
W467	3G8F7-CLK13 3G8F7-CLK12-V1 3G8F7-CLK53 3G8F7-CLK52-V1 3G8F7-CLK23 3G8F7-CLK21-V1	Controller Link Support Board for PCI Bus Installation Guide (3G8F7-CLK13/12-V1/53/52-V1/23/21-V1)	Used when information regarding setup procedures for Controller Link Support Boards for PCI bus connections is needed.	Describes the setup method for the Controller Link Support Boards for PCI bus connections.
W383	3G8F7-CLK13 3G8F7-CLK12-V1 3G8F7-CLK53 3G8F7-CLK52-V1 3G8F7-CLK23 3G8F7-CLK21-V1	Controller Link Support Boards for PCI Bus Operation Manual	Used when information regarding setup procedures for Controller Link Support Boards for PCI bus connections is needed.	Describes the setup method for the Controller Link Support Boards for PCI bus connections.
W464	CXONE-AL□□C-JV2/ AL□□D-JV2	CX-Integrator Ver. 2.1 Operation Manual	Used when network setup or network monitoring needs to be performed.	Describes the operating procedures for the CX-Integrator.
W463	CXONE-AL□□C-JV2/ AL□□D-JV2	CX-One Ver. 2.1 FA Integrated Tool Package Setup Manual	Used when installing software from the CX-One.	Provides an overview of the FA Integration Tool Package CX-One, and describes the CX-One installation procedures.

Terms and Conditions of Sale

1. **Offer; Acceptance.** These terms and conditions (these "Terms") are deemed part of all quotes, agreements, purchase orders, acknowledgments, price lists, catalogs, manuals, brochures and other documents, whether electronic or in writing, relating to the sale of products or services (collectively, the "Products") by Omron Electronics LLC and its subsidiary companies ("Omron"). Omron objects to any terms or conditions proposed in Buyer's purchase order or other documents which are inconsistent with, or in addition to, these Terms.
2. **Prices; Payment Terms.** All prices stated are current, subject to change without notice by Omron. Omron reserves the right to increase or decrease prices on any unshipped portions of outstanding orders. Payments for Products are due net 30 days unless otherwise stated in the invoice.
3. **Discounts.** Cash discounts, if any, will apply only on the net amount of invoices sent to Buyer after deducting transportation charges, taxes and duties, and will be allowed only if (i) the invoice is paid according to Omron's payment terms and (ii) Buyer has no past due amounts.
4. **Interest.** Omron, at its option, may charge Buyer 1-1/2% interest per month or the maximum legal rate, whichever is less, on any balance not paid within the stated terms.
5. **Orders.** Omron will accept no order less than \$200 net billing.
6. **Governmental Approvals.** Buyer shall be responsible for, and shall bear all costs involved in, obtaining any government approvals required for the importation or sale of the Products.
7. **Taxes.** All taxes, duties and other governmental charges (other than general real property and income taxes), including any interest or penalties thereon, imposed directly or indirectly on Omron or required to be collected directly or indirectly by Omron for the manufacture, production, sale, delivery, importation, consumption or use of the Products sold hereunder (including customs duties and sales, excise, use, turnover and license taxes) shall be charged to and remitted by Buyer to Omron.
8. **Financial.** If the financial position of Buyer at any time becomes unsatisfactory to Omron, Omron reserves the right to stop shipments or require satisfactory security or payment in advance. If Buyer fails to make payment or otherwise comply with these Terms or any related agreement, Omron may (without liability and in addition to other remedies) cancel any unshipped portion of Products sold hereunder and stop any Products in transit until Buyer pays all amounts, including amounts payable hereunder, whether or not then due, which are owing to it by Buyer. Buyer shall in any event remain liable for all unpaid accounts.
9. **Cancellation; Etc.** Orders are not subject to rescheduling or cancellation unless Buyer indemnifies Omron against all related costs or expenses.
10. **Force Majeure.** Omron shall not be liable for any delay or failure in delivery resulting from causes beyond its control, including earthquakes, fires, floods, strikes or other labor disputes, shortage of labor or materials, accidents to machinery, acts of sabotage, riots, delay in or lack of transportation or the requirements of any government authority.
11. **Shipping; Delivery.** Unless otherwise expressly agreed in writing by Omron:
 - a. Shipments shall be by a carrier selected by Omron; Omron will not drop ship except in "break down" situations.
 - b. Such carrier shall act as the agent of Buyer and delivery to such carrier shall constitute delivery to Buyer;
 - c. All sales and shipments of Products shall be FOB shipping point (unless otherwise stated in writing by Omron), at which point title and risk of loss shall pass from Omron to Buyer; provided that Omron shall retain a security interest in the Products until the full purchase price is paid;
 - d. Delivery and shipping dates are estimates only; and
 - e. Omron will package Products as it deems proper for protection against normal handling and extra charges apply to special conditions.
12. **Claims.** Any claim by Buyer against Omron for shortage or damage to the Products occurring before delivery to the carrier must be presented in writing to Omron within 30 days of receipt of shipment and include the original transportation bill signed by the carrier noting that the carrier received the Products from Omron in the condition claimed.
13. **Warranties.** (a) **Exclusive Warranty.** Omron's exclusive warranty is that the Products will be free from defects in materials and workmanship for a period of twelve months from the date of sale by Omron (or such other period expressed in writing by Omron). Omron disclaims all other warranties, express or implied. (b) **Limitations.** OMRON MAKES NO WARRANTY OR REPRESENTATION, EXPRESS OR IMPLIED, ABOUT NON-INFRINGEMENT, MERCHANTABILITY OR FITNESS FOR A PARTICULAR PURPOSE OF THE PRODUCTS. BUYER ACKNOWLEDGES THAT IT ALONE HAS DETERMINED THAT THE PRODUCTS WILL SUITABLY MEET THE REQUIREMENTS OF THEIR INTENDED USE. Omron further disclaims all warranties and responsibility of any type for claims or expenses based on infringement by the Products or otherwise of any intellectual property right. (c) **Buyer Remedy.** Omron's sole obligation hereunder shall be, at Omron's election, to (i) replace (in the form originally shipped with Buyer responsible for labor charges for removal or replacement thereof) the non-complying Product, (ii) repair the non-complying Product, or (iii) repay or credit Buyer an amount equal to the purchase price of the non-complying Product; provided that in no event shall Omron be responsible for warranty, repair, indemnity or any other claims or expenses regarding the Products unless Omron's analysis confirms that the Products were properly handled, stored, installed and maintained and not subject to contamination, abuse, misuse or inappropriate modification. Return of any Products by Buyer must be approved in writing by Omron before shipment. Omron Companies shall not be liable for the suitability or unsuitability or the results from the use of Products in combination with any electrical or electronic components, circuits, system assemblies or any other materials or substances or environments. Any advice, recommendations or information given orally or in writing, are not to be construed as an amendment or addition to the above warranty. See <http://www.omron247.com> or contact your Omron representative for published information.
14. **Limitation on Liability; Etc.** OMRON COMPANIES SHALL NOT BE LIABLE FOR SPECIAL, INDIRECT, INCIDENTAL, OR CONSEQUENTIAL DAMAGES, LOSS OF PROFITS OR PRODUCTION OR COMMERCIAL LOSS IN ANY WAY CONNECTED WITH THE PRODUCTS, WHETHER SUCH CLAIM IS BASED IN CONTRACT, WARRANTY, NEGLIGENCE OR STRICT LIABILITY. Further, in no event shall liability of Omron Companies exceed the individual price of the Product on which liability is asserted.
15. **Indemnities.** Buyer shall indemnify and hold harmless Omron Companies and their employees from and against all liabilities, losses, claims, costs and expenses (including attorney's fees and expenses) related to any claim, investigation, litigation or proceeding (whether or not Omron is a party) which arises or is alleged to arise from Buyer's acts or omissions under these Terms or in any way with respect to the Products. Without limiting the foregoing, Buyer (at its own expense) shall indemnify and hold harmless Omron and defend or settle any action brought against such Companies to the extent based on a claim that any Product made to Buyer specifications infringed intellectual property rights of another party.
16. **Property; Confidentiality.** Any intellectual property in the Products is the exclusive property of Omron Companies and Buyer shall not attempt to duplicate it in any way without the written permission of Omron. Notwithstanding any charges to Buyer for engineering or tooling, all engineering and tooling shall remain the exclusive property of Omron. All information and materials supplied by Omron to Buyer relating to the Products are confidential and proprietary, and Buyer shall limit distribution thereof to its trusted employees and strictly prevent disclosure to any third party.
17. **Export Controls.** Buyer shall comply with all applicable laws, regulations and licenses regarding (i) export of products or information; (ii) sale of products to "forbidden" or other proscribed persons; and (iii) disclosure to non-citizens of regulated technology or information.
18. **Miscellaneous.** (a) **Waiver.** No failure or delay by Omron in exercising any right and no course of dealing between Buyer and Omron shall operate as a waiver of rights by Omron. (b) **Assignment.** Buyer may not assign its rights hereunder without Omron's written consent. (c) **Law.** These Terms are governed by the law of the jurisdiction of the home office of the Omron company from which Buyer is purchasing the Products (without regard to conflict of law principles). (d) **Amendment.** These Terms constitute the entire agreement between Buyer and Omron relating to the Products, and no provision may be changed or waived unless in writing signed by the parties. (e) **Severability.** If any provision hereof is rendered ineffective or invalid, such provision shall not invalidate any other provision. (f) **Setoff.** Buyer shall have no right to set off any amounts against the amount owing in respect of this invoice. (g) **Definitions.** As used herein, "including" means "including without limitation"; and "Omron Companies" (or similar words) mean Omron Corporation and any direct or indirect subsidiary or affiliate thereof.

Certain Precautions on Specifications and Use

1. **Suitability of Use.** Omron Companies shall not be responsible for conformity with any standards, codes or regulations which apply to the combination of the Product in the Buyer's application or use of the Product. At Buyer's request, Omron will provide applicable third party certification documents identifying ratings and limitations of use which apply to the Product. This information by itself is not sufficient for a complete determination of the suitability of the Product in combination with the end product, machine, system, or other application or use. Buyer shall be solely responsible for determining appropriateness of the particular Product with respect to Buyer's application, product or system. Buyer shall take application responsibility in all cases but the following is a non-exhaustive list of applications for which particular attention must be given:
 - (i) Outdoor use, uses involving potential chemical contamination or electrical interference, or conditions or uses not described in this document.
 - (ii) Use in consumer products or any use in significant quantities.
 - (iii) Energy control systems, combustion systems, railroad systems, aviation systems, medical equipment, amusement machines, vehicles, safety equipment, and installations subject to separate industry or government regulations.
 - (iv) Systems, machines and equipment that could present a risk to life or property. Please know and observe all prohibitions of use applicable to this Product.

NEVER USE THE PRODUCT FOR AN APPLICATION INVOLVING SERIOUS RISK TO LIFE OR PROPERTY OR IN LARGE QUANTITIES WITHOUT ENSURING THAT THE SYSTEM AS A WHOLE HAS BEEN DESIGNED TO ADDRESS THE RISKS, AND THAT THE OMRON'S PRODUCT IS PROPERLY RATED AND INSTALLED FOR THE INTENDED USE WITHIN THE OVERALL EQUIPMENT OR SYSTEM.
2. **Programmable Products.** Omron Companies shall not be responsible for the user's programming of a programmable Product, or any consequence thereof.
3. **Performance Data.** Data presented in Omron Company websites, catalogs and other materials is provided as a guide for the user in determining suitability and does not constitute a warranty. It may represent the result of Omron's test conditions, and the user must correlate it to actual application requirements. Actual performance is subject to the Omron's Warranty and Limitations of Liability.
4. **Change in Specifications.** Product specifications and accessories may be changed at any time based on improvements and other reasons. It is our practice to change part numbers when published ratings or features are changed, or when significant construction changes are made. However, some specifications of the Product may be changed without any notice. When in doubt, special part numbers may be assigned to fix or establish key specifications for your application. Please consult with your Omron's representative at any time to confirm actual specifications of purchased Product.
5. **Errors and Omissions.** Information presented by Omron Companies has been checked and is believed to be accurate; however, no responsibility is assumed for clerical, typographical or proofreading errors or omissions.

Complete "Terms and Conditions of Sale" for product purchase and use are on Omron's website at www.omron.com/oei – under the "About Us" tab, in the Legal Matters section.

ALL DIMENSIONS SHOWN ARE IN MILLIMETERS.

To convert millimeters into inches, multiply by 0.03937. To convert grams into ounces, multiply by 0.03527.

OMRON[®]**OMRON ELECTRONICS LLC**

1 Commerce Drive
Schaumburg, IL 60173
Tel: 847.843.7900

For U.S. technical support or other inquiries: 800.556.6766

OMRON CANADA, INC.

885 Milner Avenue
Toronto, Ontario M1B 5V8
Tel: 416.286.6465

MEXICO SALES OFFICES

Mexico, D.F. (52) 555 660 31 44
Ciudad Juárez (52) 656 623 70 83
Monterrey, N.L. (52) 818 377 42 81
Mexicali, B.C. (52) 686 838 01 15

BRAZIL SALES OFFICES

Sao Paulo (55) 11 2101 6300

ARGENTINA SALES OFFICES

Cono Sur (54) 11 4787 1129

CHILE SALES OFFICES

Santiago (56) 2206 4592

OTHER LATIN AMERICAN SALES

mela@omron.com

OMRON ON-LINE

Global –
www.omron.com

USA –
www.omron247.com

Canada –
www.omron.ca

Brazil –
www.omron.com.br