

## Temperature Controller

## E5C4

1/16 DIN Sized, Digital-Set Controller  
Features Easy-to-Read LED Display

- Proportional-derivative (PD) control or ON/OFF control models
- Front panel offset adjustment on PD controllers
- Choose contact or voltage outputs
- Type J or K thermocouples, or platinum RTD input models
- Fits standard 8-pin round sockets
- Panel mounting hardware included
- Sockets, protective cover, and other accessories may be ordered separately



## Ordering Information

### ■ TEMPERATURE CONTROLLERS

Add the temperature range and supply voltage to the part number when you order. The minimum scale division is in parentheses. For example, **E5C4-R20K-32° to 999°F-AC120**.

Control type	Output type	Input type (specify temperature range from choices below)		
		Thermocouple type K	Thermocouple type J	Platinum RTD
ON/OFF	Contact	<b>E5C4-R20K</b>	<b>E5C4-R20J</b>	<b>E5C4-R20P-DIN</b>
	Voltage	<b>E5C4-Q20K</b>	<b>E5C4-Q20J</b>	<b>E5C4-Q20P-DIN</b>
PD	Contact	<b>E5C4-R40K</b>	<b>E5C4-R40J</b>	<b>E5C4-R40P-DIN</b>
	Voltage	<b>E5C4-Q40K</b>	<b>E5C4-Q40J</b>	<b>E5C4-Q40P-DIN</b>
Temperature ranges		0° to 399°C (1) 0° to 999°C (1) 32° to 999°F (1)	0° to 399°C (1) 32° to 999°F (1)	0° to 99.9°C (0.1) 32° to 199°F (1)
Supply voltages		110/120 VAC, 50/60 Hz or 220/240 VAC, 50/60 Hz		

### ■ ACCESSORIES

Description	Part number	
Sockets	Bottom surface or track mounting, top screw terminals	<b>P2CF-08</b>
	Back mounting, for use with Y92F-30 mounting adapter supplied, bottom screw terminals	<b>P3G-08</b>
	Back mounting plug type, for use with Y92F-30 mounting adapter supplied	<b>US08</b>
Protective cover	Soft plastic cover protects front panel against dirt and water.	<b>Y92A-48D</b>
Mounting track	DIN rail, 50 cm (1.64 ft) length	<b>PFP-50N</b>
	DIN rail, 1 m (3.28 ft) length	<b>PFP-100N</b>
	End plate	<b>PFP-M</b>
	Spacer	<b>PFP-S</b>

### ■ REPLACEMENT PART

Description	Part number
Panel mounting bracket; one supplied with each controller	<b>Y92F-30</b>

# Specifications

Part number	E5C4-□□□K	E5C4-□□□J	E5C4-□□□P-DIN
Sensor input types	Thermocouple type K	Thermocouple type J	Platinum RTD
Supply voltage	100/120 VAC, 50/60 Hz or 220/240 VAC, 50/60 Hz		
Operating voltage	90 to 110% of rated supply voltage		
Power consumption	Approx. 2 VA		
Control output	Number	One output, built in	
	Type	Relay	SPDT, 3 A, 250 VAC (resistive load), switching capacity of 330 VA
		Voltage	5 VDC, 10 mA with short-circuit protection
	Hysteresis	0.2% of full scale (fixed)	
	Service life	100,000 electrical operations minimum for relay output 10 million mechanical operations minimum for relay output	
Alarm output	Not available		
Indication accuracy	±2% maximum of full scale		
Setting accuracy	Set value coincides with the indicated value, since no relative error exists between both values		
Control modes	Type	ON/OFF (E5C4-□20□) or PD (E5C4-□40□)	
	Proportional band	3% of full scale (fixed)	
	Reset	3% minimum of full scale (variable); front panel potentiometer adjustment	
	Control period	Contact	Approx. 20 seconds, where ratio of ON to OFF is 1:1
Voltage		Approx. 2 seconds, where ratio of ON to OFF is 1:1	
Memory protection	Not available		
Indicators	Temperature Indication (3-digit red LED), Operation Indicator (red LED)		
Materials	Plastic case		
Mounting	Fits 1/16 DIN panel cutouts; includes panel mounting adapter Y92F-30		
Connections	Terminals for standard 8-pin round connectors		
Weight	Approx. 200 g (7 oz.) including panel mounting adapter		
Enclosure ratings	Front panel	IEC IP40, NEMA 4 with optional cover Y92A-48N	
	Housing	IEC IP20	
	Terminals	IEC IP00	
Approvals	UL	Recognized, File No. E68481, approved control output rating 1.5 A, 250 VAC	
	CSA	Certified, File No. LR59623, approved control output rating 1.5 A, 250 VAC	
	Other	SEV, File No. D4.11/634	
Ambient temperature	Use	-10° to 55°C (14° to 131°F)	
	Storage	-25° to 65°C (-13° to 149°F)	
Humidity	35 to 85% RH		
Insulation resistance	20 MΩ minimum at 500 VDC		
Dielectric strength	2,000 VAC, 50/60 Hz for 1 minute		
Vibration	Mechanical durability: 10 to 55 Hz 0.75 mm (0.03 in) in X, Y, and Z directions for 2 hours each		
	Malfunction durability: 2 to 55 Hz, 2 G, in X, Y, and Z directions for 10 minutes each		
Shock	Mechanical durability: 300 m/s <sup>2</sup> in 6 directions, 3 times each		
	Malfunction durability: 200 m/s <sup>2</sup> in 6 directions, 3 times each		

# Dimensions

Unit: mm (inch)

## ■ TEMPERATURE CONTROLLER

### E5C4

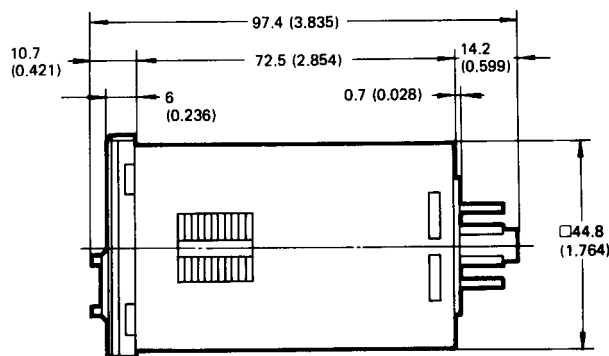
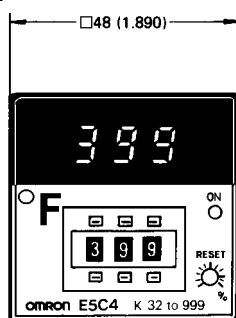

### Panel cutout

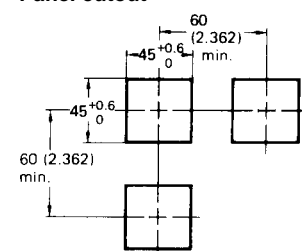

NOTE: Recommended panel thickness is 1 to 4 (0.039 to 0.157).

E5C4 Temperature Controller Mounted in Y92F-30 Panel Mounting Adapter (supplied)

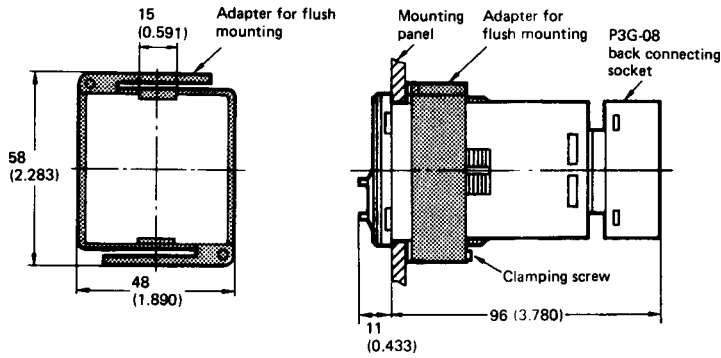

■ SOCKETS

P2CF-08 Bottom surface or track mounting socket

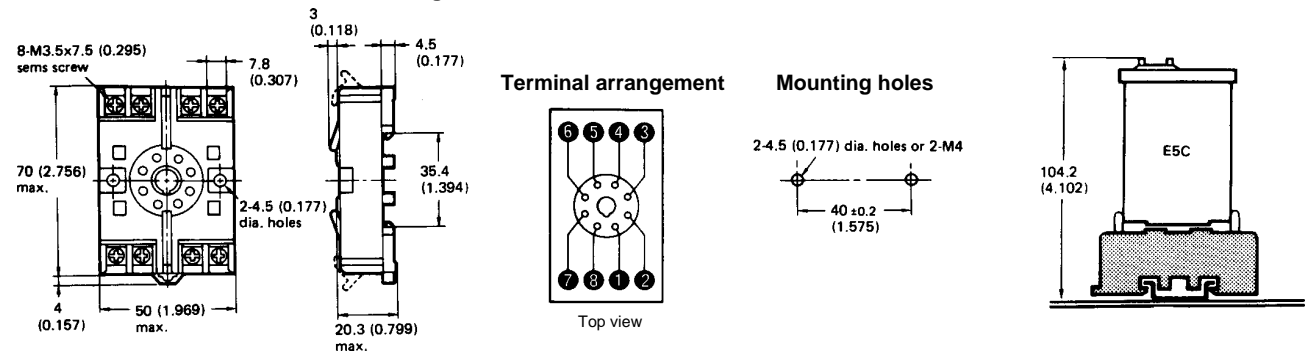

P3G-08 Back mounting socket

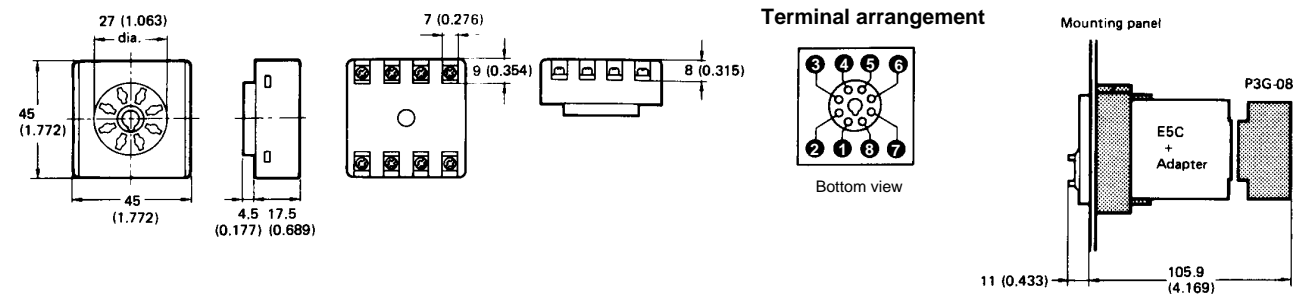

US08 Back-mounting socket

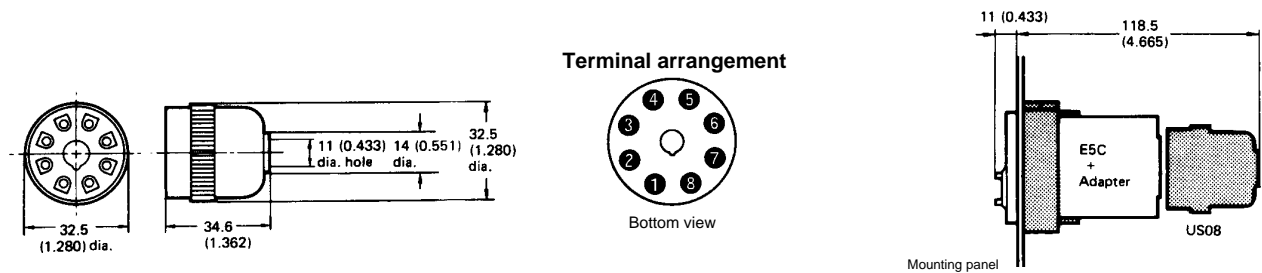

■ PROTECTIVE COVER

Y92A-48D

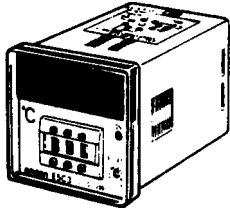

Soft plastic cover Y92A-48D fits snugly over the front and allows settings to be changed. It shields the front panel from dirt and water. The cover is intended for use in areas where unusual service conditions do not exist.

■ MOUNTING TRACK AND ACCESSORIES

PFP-100N/PFP-50N DIN Rail

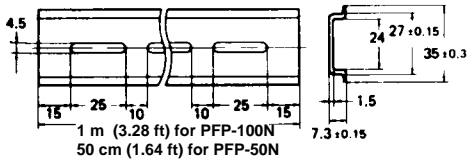

PFP-M End Plate

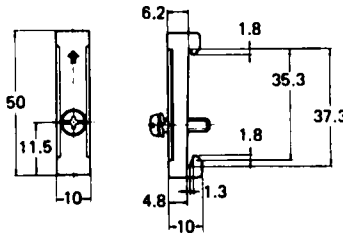

PFP-S Spacer

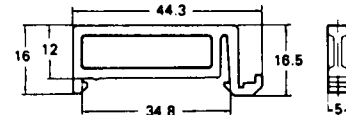

Nomenclature

E5C4

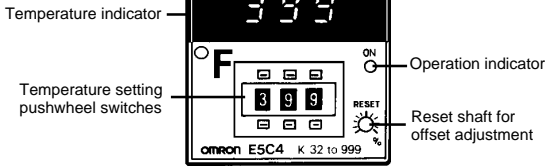

Note:  
Depending on the scale range, the leftmost digit cannot be set to any digits other than those shown below. A stopper mechanism is built in to prevent impossible settings.

Scale range	Permissible digits
0° to 399°C	0, 1, 2 and 3
32° to 199°F	0 and 1

Connections

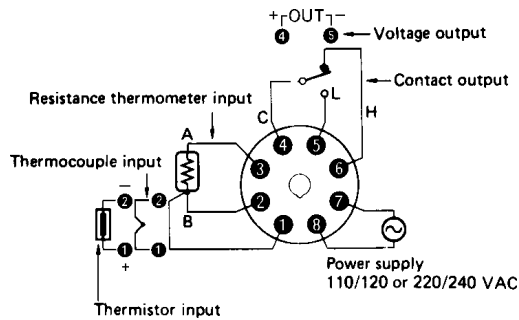

Contact output

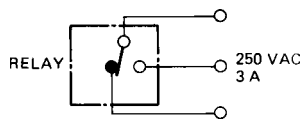

Voltage output

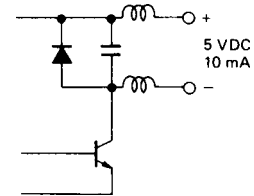

---

**OMRON**<sup>®</sup>

**OMRON ELECTRONICS, INC.**

One East Commerce Drive  
Schaumburg, IL 60173

**1-800-55-OMRON**

**OMRON CANADA, INC.**

885 Milner Avenue  
Scarborough, Ontario M1B 5V8

**416-286-6465**