

Water- and Environment-resistive FA Connectors Save Wiring and Maintenance Effort



- Compact FA connectors meet IP67 requirements and ensure a 94V-0 fire retardant rating.
- A wide array of connectors makes a wiring system more modular, simplifies maintenance, and reduces downtime.
- Connectors with Cables and Connector Assemblies are available.
- Three types of Connector Assembly: Crimping, soldering, and screw-on.
- Connectors with Cables are UL certified.
- Based on IEC61076-2-101.



Refer to Safety Precautions on page 34.

For the most recent information on models that have been certified for safety standards, refer to your OMRON website. Smartclick is a trademark or registered trademark of OMRON Corporation in Japan and other countries.

Model Number Legend

Connectors with Cables Model Number Legend

| Connector | Cable specifications | XS2: M12 Screw Connection | | | XS5: One-touch Smartclick Connection* (compatible with M12 connectors) | | | |
|-------------------------------|-----------------------------------|-------------------------------------|---------------------------------|------------------|--|------------------|-----------------|-----------------|
| | | Cable length (m) | Model | Reference page | Cable length (m) | Model | | |
| Connectors on both cable ends | Fire-retardant, PVC robot cable | 0.5 | XS2W-D421-B81-F | 5 | 0.5 | XS5W-D421-B81-F | | |
| | | 1 | XS2W-D421-C81-F | | 1 | XS5W-D421-C81-F | | |
| | | 2 | XS2W-D421-D81-F | | 2 | XS5W-D421-D81-F | | |
| | | 3 | XS2W-D421-E81-F | | 3 | XS5W-D421-E81-F | | |
| | | 4 | XS2W-D421-F81-F | | 4 | XS5W-D421-F81-F | | |
| | | 5 | XS2W-D421-G81-F | | 5 | XS5W-D421-G81-F | | |
| | | 10 | XS2W-D421-J81-F | | 10 | XS5W-D421-J81-F | | |
| | | 15 | XS2W-D421-K81-F | | 15 | XS5W-D421-K81-F | | |
| | Spatter-resistant cable | 2 | XS2W-D421-D81-SA | 2 | XS5W-D421-D81-SA | | | |
| | | 5 | XS2W-D421-G81-SA | 5 | XS5W-D421-G81-SA | | | |
| | | Connector on one cable end (Socket) | Fire-retardant, PVC robot cable | 1 | XS2F-D421-C80-F | 7 | 1 | XS5F-D421-C80-F |
| | | | | 2 | XS2F-D421-D80-F | | 2 | XS5F-D421-D80-F |
| | | | | 3 | XS2F-D421-E80-F | | 3 | XS5F-D421-E80-F |
| | | | | 5 | XS2F-D421-G80-F | | 5 | XS5F-D421-G80-F |
| 10 | XS2F-D421-J80-F | | | 10 | XS5F-D421-J80-F | | | |
| 15 | XS2F-D421-K80-F | | | 15 | XS5F-D421-K80-F | | | |
| Spatter-resistant cable | 2 | | XS2F-D421-D80-SA | 2 | XS5F-D421-D80-SA | | | |
| | 5 | XS2F-D421-G80-SA | 5 | XS5F-D421-G80-SA | | | | |
| | Connector on one cable end (Plug) | Fire-retardant, PVC robot cable | 0.3 | XS2H-D421-A80-F | 14 | 0.3 | XS5H-D421-A80-F | |
| 0.5 | | | XS2H-D421-B80-F | 0.5 | | XS5H-D421-B80-F | | |
| 1 | | | XS2H-D421-C80-F | 1 | | XS5H-D421-C80-F | | |
| 2 | | | XS2H-D421-D80-F | 2 | | XS5H-D421-D80-F | | |
| 3 | | | — | 3 | | XS5H-D421-E80-F | | |
| 5 | | XS2H-D421-G80-F | 5 | XS5H-D421-G80-F | | | | |
| Spatter-resistant cable | | 0.3 | XS2H-D421-A80-SA | 0.3 | | XS5H-D421-A80-SA | | |
| | | 1 | XS2H-D421-C80-SA | 1 | | XS5H-D421-C80-SA | | |

*For details, refer to the data sheet of the XS5 Round Water-resistant Connectors (M12 Smartclick).
 Note 1. Only DC, straight, 4-core types, and common cable specifications are shown above. Refer to the relevant pages for other products.
 2. Other than the M12 sizes introduced above, M8-sized (XS3) products are also available.
 For details, refer to the data sheet of the XS3 Round Water-resistant Connectors (M8/S8).

XS2: M12 Screw Connection

XS5: One-touch Smartclick Connection* (compatible with M12 screws)

Note: Screw connections will be made if connecting with a screw type.



Turn approx. 1/8 of a turn to connect Connections can be checked using markings

*For details, refer to the data sheet of the XS5 Round Water-resistant Connectors (M12 Smartclick).

Ratings and Specifications

| | |
|-------------------------------------|--|
| Rated current | 4 A |
| Rated voltage | 250 VAC/VDC |
| Contact resistance (Connector) | 40 mΩ max. (20 m V max. and 100 mA max.) |
| Insulation resistance | 1,000 MΩ min. (at 500 VDC) |
| Dielectric strength (Connector) | 1,500 VAC for 1 min (leakage current: 1 mA max.) |
| Degree of protection | IP67 (IEC60529) |
| Insertion tolerance | 200 times |
| Cable holding strength | Cable diameter: 6 mm 98 N/15 s 4 to 5 mm 49 N/15 s 3 mm 29 N/15 s |
| Ambient operating temperature range | -25 to 70°C * |
| Ambient humidity range | 20% to 85% |

*Use the robot cable within a temperature range between 0°C and 70°C to prevent the wires inside the cable from being broken when bending it.

Materials and Finish

| Item | Model | XS2F/H/W | XS2F-LED | XS2M/R/P | XS2C/G |
|----------------|---|---|---|----------|-----------|
| Contacts | | Copper alloy/Gold plating | | Brass | |
| Thread bracket | | Copper alloy/Nickel plated * | | | |
| Pin block | | PBT resin | | PA resin | PBT resin |
| O-ring | | Rubber | | | |
| Cover | | PBT resin | TPU resin | — | PBT resin |
| Cable | Fire-retardant, PVC robot cable | UL AWM2464 CL3, 6 mm dia. AWG20 Sheath color: light gray | — | — | — |
| | Non-polar DC Connectors with Standard PVC cable | 6 mm dia. AWG20 Sheath color: light gray | — | — | — |
| | E2E models with conventional connector pin with Fire-retardant, PVC robot cable | UL AWM2464 CL3, 6 mm dia. AWG20 Sheath color: light gray | — | — | — |
| | Standard PVC cable up to 105°C | 6 mm dia. AWG20 Sheath color: light gray | — | — | — |
| | Spatter-resistant cable | 6.6 mm dia. AWG20 Sheath color: blue | — | — | — |
| | Standard PVC cable (XS2F-LED) | — | UL AWM2464 5.0 mm dia. (3 conductors) 5.4 mm dia. (4 conductors) 0.34 mm ² Sheath color: black | — | — |

*The T-joint of the XS2R is aluminum/white.

Pin Arrangement (Engaged Side)

| Item | No. of poles | 4 poles | 5 poles |
|---------|--------------------------|---------|---------|
| DC type | Male (plug) contacts | | |
| | Female (socket) contacts | | |
| AC type | Male (plug) contacts | | — |
| | Female (socket) contacts | | — |

Note: The AC and DC mating section forms are different as shown here and therefore cannot be connected together.

Connections

Connection Combinations

| OMRON model No. | | M12 Plug Connectors | Smartclick Plug Connectors |
|------------------------------|---|---|---|
| | | XS2H, XS2G, XS2W (plug side), XS2R (plug side), XS2M | XS5H, XS5G, XS5W (plug side), XS5R (plug side), XS5M |
| M12 Socket Connectors | XS2F, XS2C, XS2W (socket side), XS2R (socket side), XS2P | ○ | ○ |
| Smartclick Socket Connectors | XS5F, XS5C, XS5W (socket side), XS5R (socket side), XS5P | ○ | ⊗ |

⊗: Connected by twisting.

○: Connected by screwing.

Note: The XS□M and XS□P cannot mate with each other.

XS2W Sockets and Plugs on Both Cable Ends

Model Number Structure

Model Number Legend

Use this model number legend to identify products from their model number. Use this model number legend to identify products from their model number. When ordering, use a model number from the table in *Ordering Information*.

XS2W-D **2** **1**

1
2
3
4
5
6
7
8
9

1. Type

W: Connectors with cables, socket and plug on both cable ends

2. AC/DC (Mating Section Form)

D: For DC

3. Connector Poles

4: 4 poles

5: 5 poles

4. Contact Plating

2: Gold plating

5. Cable Connection Direction

1: Straight (socket)/Straight (plug)

2: Right-angle (socket)/Right-angle (plug)

3: Straight (socket)/Right-angle (plug)

4: Right-angle (socket)/Straight (plug)

6. Cable Length

A : 0.3 m

B : 0.5 m

C : 1 m

D : 2 m

E : 3 m

F : 4 m

G : 5 m

H : 7 m

J : 10 m

K : 15 m

L : 20 m

7. Connections (Numbers inside circles are terminal numbers)

8 : ① Brown, ② White, ③ Blue, ④ Black (for DC)

G : ① Brown, ② White, ③ Blue, ④ Black, ⑤ Gray

8. Connectors on One End/Both Ends

1: Both ends

9. Cable Specifications

F : Fire-retardant, PVC robot cable

SA : Spatter-resistant cable

S : Standard PVC cable

XS2W Sockets and Plugs on Both Cable Ends

Ordering Information

| Cable specifications | Cable connection direction | No. of cable cores | Cable diameter (mm) | Cable core cross-sectional area (mm ²) | Cable length L (m) | DC | UL | |
|---------------------------------|--|--------------------|---------------------|--|---|------------------|---|----------|
| | | | | | | Model | | |
| Fire-retardant, PVC robot cable | Straight (Plug)/ Straight (Socket) | 4 | 6.0 dia. | 0.5 | 0.5 | XS2W-D421-B81-F | UL 2238 certified (File No. E207683) | |
| | | | | | 1 | XS2W-D421-C81-F | | |
| | | | | | 2 | XS2W-D421-D81-F | | |
| | | | | | 3 | XS2W-D421-E81-F | | |
| | | | | | 4 | XS2W-D421-F81-F | | |
| | | | | | 5 | XS2W-D421-G81-F | | |
| | | | | | 10 | XS2W-D421-J81-F | | |
| | | | | | 15 | XS2W-D421-K81-F | | |
| | | | | | 20 | XS2W-D421-L81-F | | |
| | | | | | Right-angle (Plug)/ Right-angle (Socket) | 4 | | 6.0 dia. |
| | 5 | XS2W-D422-G81-F | | | | | | |
| | Straight (Socket)/ Right-angle (Plug) | 2 | XS2W-D423-D81-F | | | | | |
| | | 5 | XS2W-D423-G81-F | | | | | |
| | Right-angle (Socket)/ Straight (Plug) | 4 | 6.0 dia. | 0.5 | 1 | XS2W-D424-C81-F | | |
| 2 | | | | | XS2W-D424-D81-F | | | |
| Standard Cable | Straight (Plug)/ Straight (Socket) | 5 | 6.0 dia. | 0.3 | 5 | XS2W-D424-G81-F | | |
| | | | | | 10 | XS2W-D424-J81-F | | |
| Spatter-resistant cable | Straight (Plug)/ Straight (Socket) | 4 | 6.6 dia. | 0.5 | 2 | XS2W-D521-DG1-A | — | |
| | | | | | 5 | XS2W-D521-GG1-A | — | |
| Spatter-resistant cable | Straight (Plug)/ Straight (Socket) | 4 | 6.6 dia. | 0.5 | 2 | XS2W-D421-D81-SA | — | |
| | | | | | 5 | XS2W-D421-G81-SA | — | |

Note: Ask your OMRON representative about other cable lengths.

Dimensions

Straight (Socket)/Straight (Plug)
 Fire-retardant, PVC robot cable
 XS2W-D421-□81-F
 Spatter-resistant cable
 XS2W-D421-D81-SA
 Standard cable (5 cores)
 XS2W-D521-□G1-A

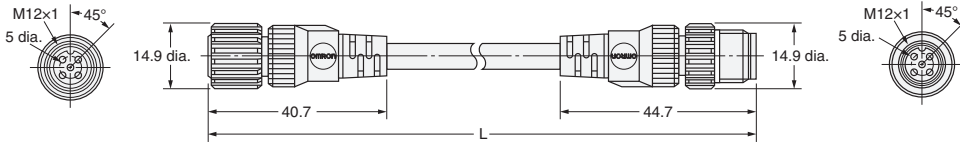

Right-angle/Right-angle
 Fire-retardant, PVC robot cable
 XS2W-D422-□81-F

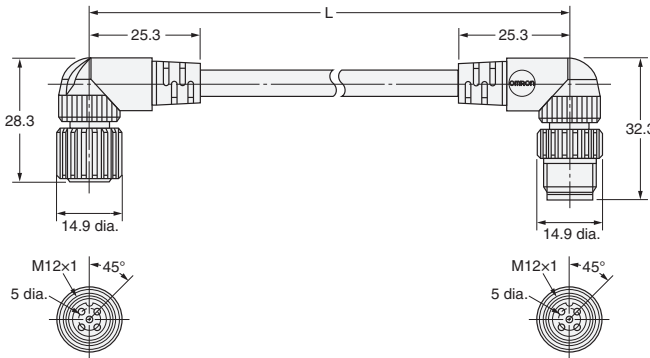

Wiring Diagram for 4 Cores

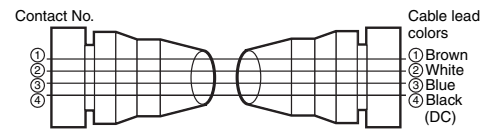

Straight (Socket)/Right-angle (Plug)
 Fire-retardant, PVC robot cable
 XS2W-D423-□81-F

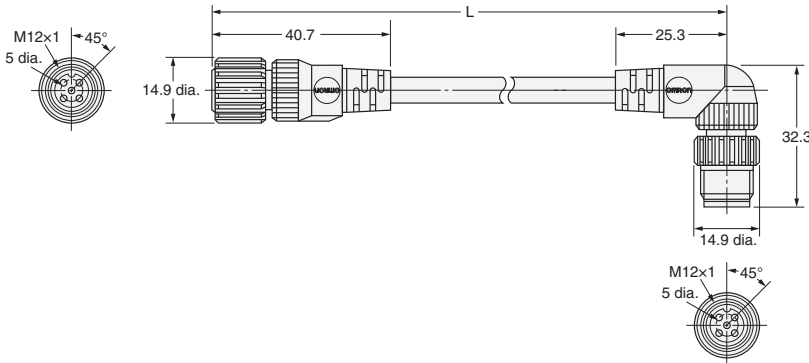

Wiring Diagram for 5 Cores

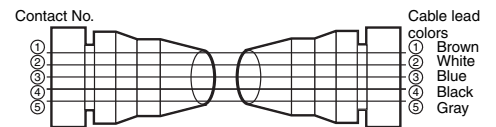

Right-angle (Socket)/Straight (Plug)
 Fire-retardant, PVC robot cable
 XS2W-D424-□81-F

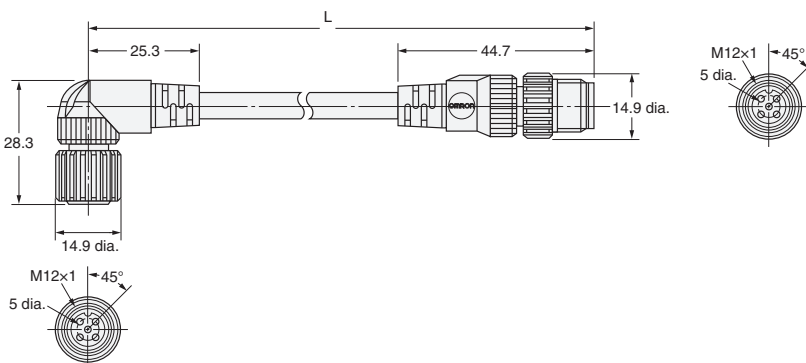

XS2F Socket on One Cable End

Model Number Structure

Model Number Legend

Use this model number legend to identify products from their model number. Use this model number legend to identify products from their model number. When ordering, use a model number from the table in *Ordering Information*.

XS2F- **2** **0**-

1
2
3
4
5
6
7
8
9

1. Type

F: Connector with cables, socket on one cable end

2. AC/DC (Mating Section Form)

A: For AC

D: For DC

E: For DC, stainless steel lock

3. Connector Poles

4: 4 poles

5: 5 poles

4. Contact Plating

2: Gold plating

5. Cable Connection Direction

1: Straight

2: Right-angle

6. Cable Length

A : 0.3 m

B : 0.5 m

C : 1 m

D : 2 m

E : 3 m

F : 4 m

G : 5 m

H : 7 m

J : 10 m

K : 15 m

L : 20 m

Note: Only the 2 m (D), 5 m (G) and 10 m (J), 20 m (L) cables are available for cables with 5 poles.

7. Connections

(Numbers inside circles are terminal numbers)

A : ① Brown, ② ---, ③ ---, ④ Blue (for DC)

B : ① ---, ② ---, ③ Brown, ④ Blue (for AC)

C : ① Brown, ② ---, ③ Blue, ④ Black

D : ① ---, ② ---, ③ Blue, ④ Brown

8 : ① Brown, ② White, ③ Blue, ④ Black (for DC)

9 : ① Brown, ② White, ③ Blue, ④ Black (for AC)

G : ① Brown, ② ---, ③ Blue, ④ Black, ⑤ Gray

8. Connectors on One End/Both Ends

0: One end

9. Cable Specifications

F: Fire-retardant, PVC robot cable

E: Heat-resistant cable up to 105°C

SA: Spatter-resistant cable

A: Standard PVC cable

Note: E type and SA type is a 4-core cable.

Designations for Non-polar DC
(For Limit Switches and Sensors)

6. Cable Length

3: 2 m

4: 5 m

7. Connections

(Numbers inside circles are terminal numbers)

1: ① ---, ② ---, ③ Black, ④ White

8. Connectors on One End/Both Ends

0: One end

9. Cable Specifications

Not designated.

Note: DC non-polarity models have different specific codes. (6, 7 and 9)

XS2F Socket on One Cable End

Ordering Information

| Cable specifications | Cable connection direction | No. of cable cores | Cable diameter (mm) | Cable core cross-sectional area (mm ²) | Cable length L (m) | DC | AC | UL | | | | |
|---|----------------------------|--------------------|---------------------|--|--------------------|------------------|------------------|--------------------------------------|-----------------|-----------------|-----------------|--|
| | | | | | | Model | Model | | | | | |
| Fire-retardant, PVC robot cable | Straight | 2 | 6.0 dia. | 0.5 | 1 | XS2F-D421-CA0-F | XS2F-A421-CB0-F | UL 2238 certified (File No. E207683) | | | | |
| | | 3 | | | | XS2F-D421-CC0-F | — | | | | | |
| | | 4 | | | | XS2F-D421-C80-F | XS2F-A421-C90-F | | | | | |
| | | 2 | | | 2 | XS2F-D421-DA0-F | XS2F-A421-DB0-F | | | | | |
| | | 3 | | | | XS2F-D421-DC0-F | — | | | | | |
| | | 4 | | | | XS2F-D421-D80-F | XS2F-A421-D90-F | | | | | |
| | | 4 | | | 3 | XS2F-D421-E80-F | — | | | | | |
| | | 2 | | | 5 | XS2F-D421-GA0-F | XS2F-A421-GB0-F | | | | | |
| | | 3 | | | | XS2F-D421-GC0-F | — | | | | | |
| | | 4 | | | | XS2F-D421-G80-F | XS2F-A421-G90-F | | | | | |
| | | 2 | | | 10 | XS2F-D421-JA0-F | XS2F-A421-JB0-F | | | | | |
| | | 3 | | | | XS2F-D421-JC0-F | — | | | | | |
| | | 4 | | | | XS2F-D421-J80-F | XS2F-A421-J90-F | | | | | |
| | | 15 | | | 15 | XS2F-D421-K80-F | — | | | | | |
| | 20 | 20 | | | XS2F-D421-L80-F | — | | | | | | |
| | Right-angle | 2 | | | 2 | 6.0 dia. | 0.5 | | 1 | XS2F-D422-CA0-F | XS2F-A422-CB0-F | |
| | | | | | 3 | | | | | XS2F-D422-CC0-F | — | |
| | | | | | 4 | | | | | XS2F-D422-C80-F | — | |
| | | | | | 2 | | | | | XS2F-D422-DA0-F | XS2F-A422-DB0-F | |
| | | 3 | | | 2 | | | | XS2F-D422-DC0-F | — | | |
| | | 4 | | | | | | | XS2F-D422-D80-F | — | | |
| | | 4 | | | | | | | XS2F-D422-E80-F | — | | |
| | | 2 | | | 5 | | | | XS2F-D422-GA0-F | XS2F-A422-GB0-F | | |
| | | 3 | | | | | | | XS2F-D422-GC0-F | — | | |
| | | 4 | | | | | | | XS2F-D422-G80-F | — | | |
| | | 2 | | | 10 | | | | XS2F-D422-JA0-F | XS2F-A422-JB0-F | | |
| | | 3 | | | | | | | XS2F-D422-JC0-F | — | | |
| | | 4 | | | | | | | XS2F-D422-J80-F | — | | |
| Non-polar DC Connectors with Standard PVC cable | | Straight | 2 | 6.6 dia. | | | | 2 | XS2F-D421-310 | XS2F-A421-310 | — | |
| | 2 | | 5 | | | XS2F-D421-410 | XS2F-A421-410 | | | | | |
| | Right-angle | 2 | 2 | | | XS2F-D422-310 | — | | | | | |
| | | 2 | 5 | | | XS2F-D422-410 | XS2F-A422-410 | | | | | |
| E2E models with conventional connector pin with Fire-retardant, PVC robot cable | Straight | 2 | | | 2 | XS2F-D421-DD0 | — | — | | | | |
| | | 2 | | | 5 | XS2F-D421-GD0 | — | | | | | |
| | Right-angle | 2 | | | 2 | XS2F-D422-DD0 | — | | | | | |
| | | 2 | | | 5 | XS2F-D422-GD0 | — | | | | | |
| Heat-resistant cable up to 105°C * | Straight | 4 | | | 2 | XS2F-E421-D80-E | — | — | | | | |
| | | | | | 5 | XS2F-E421-G80-E | — | | | | | |
| | Right-angle | | | | 2 | 2 | XS2F-E422-D80-E | | — | | | |
| | | | | | 5 | 5 | XS2F-E422-G80-E | | — | | | |
| Spatter-resistant cable | Straight | 4 | 6.6 dia. | | 2 | XS2F-D421-D80-SA | — | — | | | | |
| | | | | | 5 | 5 | XS2F-D421-G80-SA | | — | | | |
| Standard PVC cable | Straight | 5 | 6.0 dia. | 0.3 | 2 | XS2F-D521-DG0-A | — | — | | | | |
| | | | | | 5 | 5 | XS2F-D521-GG0-A | | — | | | |
| | | | | | 10 | 10 | XS2F-D521-JG0-A | | — | | | |
| | 20 | | | | 20 | XS2F-D521-LG0-A | — | | | | | |
| | Right-angle | | | | 2 | 2 | XS2F-D522-DG0-A | | — | | | |
| 5 | | 5 | XS2F-D522-GG0-A | — | | | | | | | | |

Note: Ask your OMRON representative about other cable lengths.

*The heat-resistant fixture material is SUS316L stainless steel without surface treatment.

Dimensions

Straight Connectors

Fire-retardant, PVC robot cable

XS2F-D421-□□□0-F

XS2F-A421-□□□0-F

Non-polar DC Connectors with Standard PVC cable

XS2F-D421-□□□0

XS2F-A421-□□□0

E2E models with conventional connector pin with Fire-retardant, PVC robot cable

XS2F-D421-□□□0

Heat-resistant cable up to 105°C

XS2F-E421-□□80-E

Spatter-resistant cable

XS2F-D421-□□80-SA

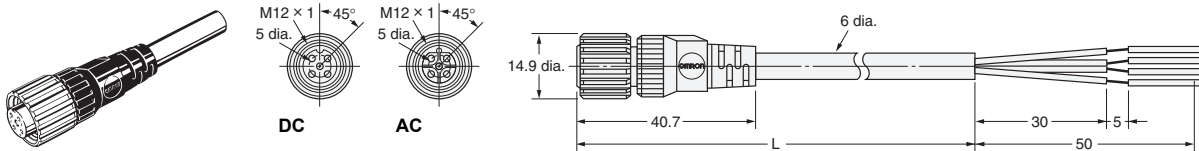

Right-angle Connectors

Fire-retardant, PVC robot cable

XS2F-D422-□□□0-F

XS2F-A422-□□□0-F

Non-polar DC Connectors with Standard PVC cable

XS2F-D422-□□□0

XS2F-A422-□□□0

E2E models with conventional connector pin with Fire-retardant, PVC robot cable

XS2F-D422-□□□0

Heat-resistant cable up to 105°C

XS2F-E422-□□80-E

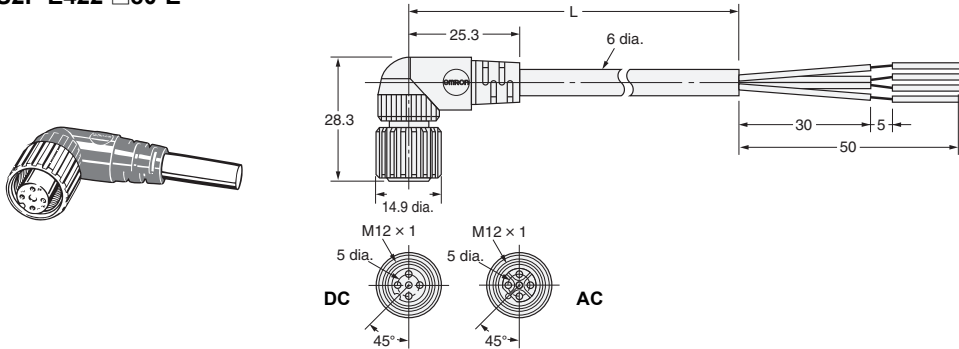

Wiring Diagram

| | | Two-core | Three-core | Four-core |
|---|-------------------|----------|------------|-----------|
| Fire-retardant, PVC robot cable | XS2F-□42□-□□□0-F | | | |
| Spatter-resistant cable * | XS2F-D421-□□80-SA | | | |
| Heat-resistant cable up to 105°C * | XS2F-E42□-□□80-E | | | |
| Non-polar DC Connectors with Standard PVC cable | XS2F-□42□-□□□0 | | — | — |
| E2E models with conventional connector pin with Fire-retardant, PVC robot cable | XS2F-D42□-□□D0 | | — | — |

*Spatter-resistant Cables and Heat-resistant Cables (105°C) are available only for four cores and DC.

Dimensions

Straight
Standard PVC cable
XS2F-D521-□G0-A

Note:
 Use the XS2H-D521-□G0-A in combination
 with the XS2F-D521-□G0-A.

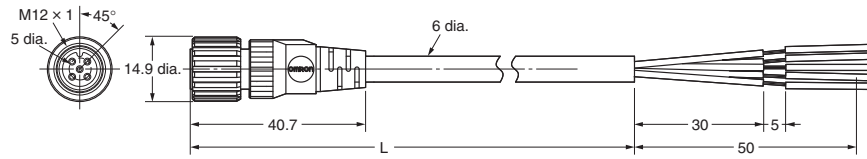
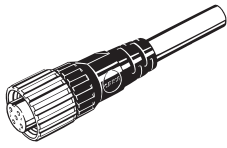

Wiring Diagram

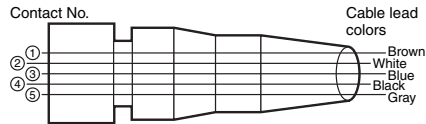

Right-angle
Standard PVC cable
XS2F-D522-□G0-A

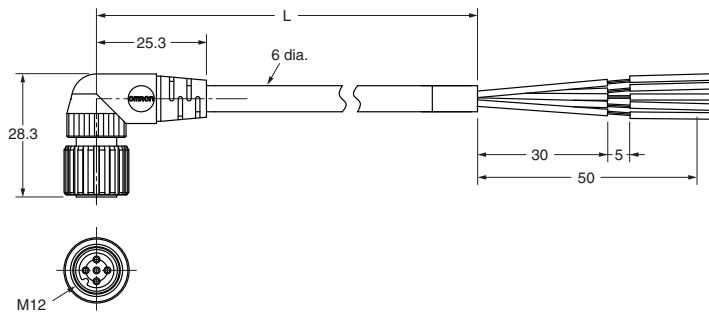
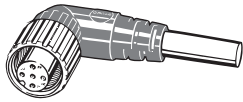

For details on connecting with E2E Proximity Sensors, refer to E2E Small-diameter Proximity Sensor Data Sheet (Cat. No.: SCEC-044).

XS2F-G/H Connectors with Cables, Socket on One Cable End, Screw Loosening-preventing Structure Type

Model Number Structure

Model Number Legend

Use this model number legend to identify products from their model number. Use this model number legend to identify products from their model number. When ordering, use a model number from the table in *Ordering Information*.

XS2F-□42□-□□□-F

1
2
3
4
5

1. Type

F: Connector with cables, sockets on one cable end

2. AC/DC

G: For DC

H: For AC

3. Cable Connection Direction

1: Straight

2: Right-angle

4. Cable Length

G80 : 5m (for DC)

G90 : 5m (for AC)

J80 : 10m (for DC)

J90 : 10m (for AC)

5. Structure

Screw Loosening-preventing

Ordering Information

| Cable connection direction | No. of cable cores | Cable length L (m) | DC | AC | UL |
|----------------------------|--------------------|--------------------|-----------------|-----------------|---|
| | | | Model | Model | |
| Straight | 4 | 5 | XS2F-G421-G80-F | XS2F-H421-G90-F | UL 2238 certified (File No. E207683) |
| | | 10 | XS2F-G421-J80-F | XS2F-H421-J90-F | |
| Right-angle | | 5 | XS2F-G422-G80-F | XS2F-H422-G90-F | |
| | | 10 | XS2F-G422-J80-F | XS2F-H422-J90-F | |

Dimensions

Straight

XS2F-G421-□80-F

XS2F-G421-□90-F

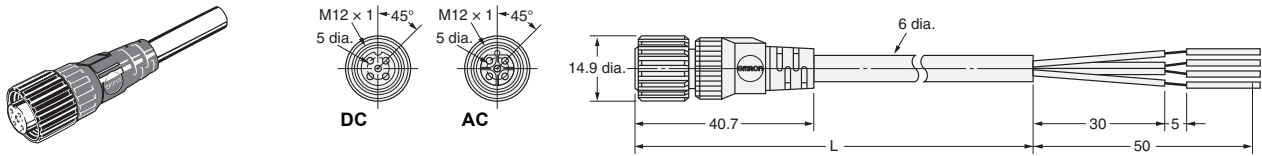

Right-angle

XS2F-G422-□80-F

XS2F-G422-□90-F

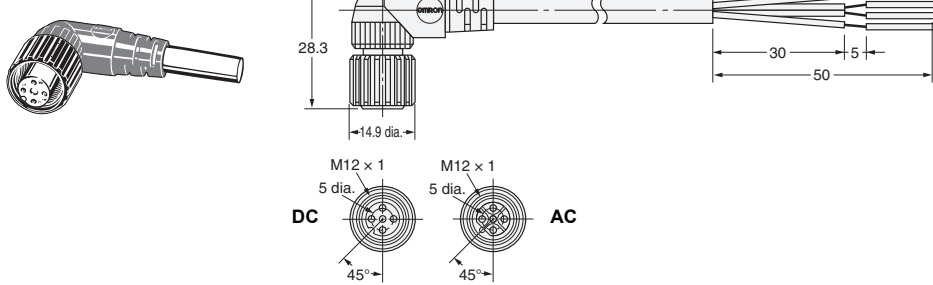

Features

Screw Loosening-preventing Structure

Appearance



Structure

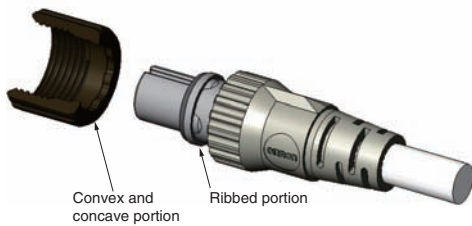

By the above structure, the convex and concave portion of the thread bracket and housing ribs interfere with each other at 45° increments to work as a loosening-preventing mechanism when engaged.

XS2F Sockets on One Cable End with Indicator

Model Number Structure

Model Number Legend

Use this model number legend to identify products from their model number. Use this model number legend to identify products from their model number. When ordering, use a model number from the table in *Ordering Information*.

XS2F-M12PVC□A□□M□LED

1 2 3 4 5 6 7 8

1. Type

F: Connector with cables, sockets on one cable end

4. Connector Poles

3: 3 poles
4: 4 poles

7. Applicable Sensors

P: PNP
N: NPN

2. Mating Section Form

M12: M12

5. Cable Connection Direction

A: Right-angle

8. With indicator

LED: With indicator

3. Cable Material

PVC: PVC

6. Cable Length

2 : 2 m
5 : 5 m
10 : 10 m

Ordering Information

| Cable specifications | Cable connection direction | Cable diameter (mm) | No. of cable cores | Cable core cross-sectional area (mm ²) | Cable length L (m) | LED | Model | UL |
|----------------------|----------------------------|---------------------|--------------------|--|--------------------|-----|----------------------|--------------------------------------|
| PVC | Right-angle | 5 dia. | 3 | 0.34 | 2 | PNP | XS2F-M12PVC3A2MPLED | UL 2238 certified (File No. E207683) |
| | | | | | 5 | | XS2F-M12PVC3A5MPLED | |
| | | | | | 10 | | XS2F-M12PVC3A10MPLED | |
| | | | | | 2 | NPN | XS2F-M12PVC3A2MNLED | |
| | | | | | 5 | | XS2F-M12PVC3A5MNLED | |
| | | | | | 10 | | XS2F-M12PVC3A10MNLED | |
| | | 5.4 dia. | 4 | | 2 | PNP | XS2F-M12PVC4A2MPLED | |
| | | | | | 5 | | XS2F-M12PVC4A5MPLED | |
| | | | | | 10 | | XS2F-M12PVC4A10MPLED | |
| | | | | | | | | |

Dimensions

(Unit: mm)

Right-angle

XS2F-M12PVC3A□MPLED
XS2F-M12PVC4A□MPLED

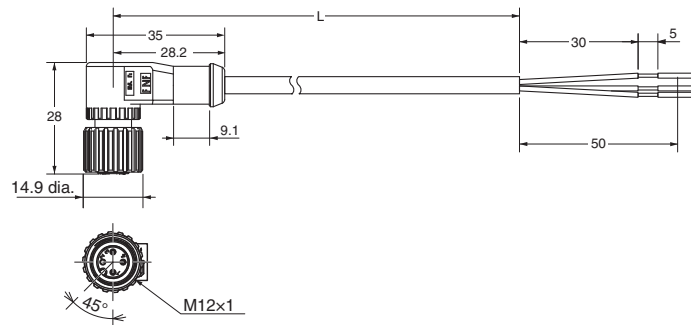
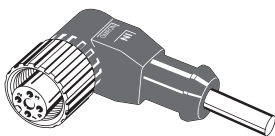

Wiring Diagram

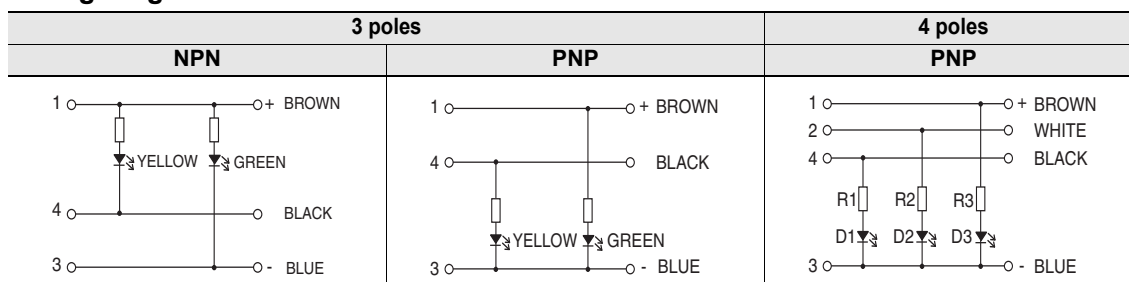

XS2H Plugs on One Cable End

Model Number Structure

Model Number Legend

Use this model number legend to identify products from their model number. When ordering, use a model number from the table in *Ordering Information*.

XS2H-□□21-□□0-□□

1
2
3
4
5
6
7
8
9

1. Type

H: Connector with cables, plug on one cable end

2. AC/DC

A: For AC

D: For DC

3. Connector Poles

4: 4 poles

5: 5 poles

4. Contact Plating

2: Gold plating

5. Cable Connection Direction

1: Straight

6. Cable Length

A : 0.3 m

B : 0.5 m

C : 1 m

D : 2 m

G : 5 m

7. Connections (Numbers inside circles are terminal numbers)

8 : ① Brown, ② White, ③ Blue, ④ Black (for DC)

9 : ① Brown, ② White, ③ Blue, ④ Black (for AC)

A : ① Brown, ② ---, ③ ---, ④ Blue (for DC)

B : ① ---, ② ---, ③ Brown, ④ Blue (for AC)

C : ① Brown, ② ---, ③ Blue, ④ Black (for DC)

G : ① Brown, ② White, ③ Blue, ④ Black, ⑤ Gray

8. Connectors on One End/Both Ends

0: One end

9. Cable Specifications

A :Standard cable

F :Fire-retardant, PVC robot cable

SA :Spatter-resistant cable

XS2H Plugs on One Cable End

Ordering Information

| Cable specifications | No. of connector poles | Cable connection direction | Cable diameter (mm) | No. of cable cores | Cable core cross-sectional area (mm ²) | Cable length L (m) | DC | AC | UL | | | | | | |
|---------------------------------|------------------------|----------------------------|---------------------|-------------------------|--|--------------------|-----------------|-----------------|--------------------------------------|---|-----|-----|------------------|---|---|
| | | | | | | | Model | Model | | | | | | | |
| Fire-retardant, PVC robot cable | 4 | Straight Connectors | 6.0 dia. | 2 | 0.5 | 0.3 | XS2H-D421-AA0-F | XS2H-A421-AB0-F | UL 2238 certified (File No. E207683) | | | | | | |
| | | | | 3 | | | XS2H-D421-AC0-F | — | | | | | | | |
| | | | | 4 | | | XS2H-D421-A80-F | XS2H-A421-A90-F | | | | | | | |
| | | | | 2 | | 1 | 0.5 | XS2H-D421-B80-F | | — | | | | | |
| | | | | 3 | | | XS2H-D421-CA0-F | XS2H-A421-CB0-F | | | | | | | |
| | | | | 4 | | | XS2H-D421-CC0-F | — | | | | | | | |
| | | | | 4 | | | XS2H-D421-C80-F | XS2H-A421-C90-F | | | | | | | |
| | | | | Spatter-resistant cable | | 4 | | 6.6 dia. | | 4 | 0.3 | 0.3 | XS2H-D421-A80-SA | — | — |
| | | | | | | | | | | | | 1 | XS2H-D421-C80-SA | — | |
| | | | | Standard cable | | 5 | | 6.0 dia. | | 5 | 0.3 | 0.3 | XS2H-D521-AG0-A | — | — |
| 1 | XS2H-D521-CG0-A | — | | | | | | | | | | | | | |

Note: Ask your OMRON representative about other cable lengths.

Dimensions

(Unit: mm)

Straight (4 poles)

Fire-retardant, PVC robot cable XS2H-□421-□□0-F

Spatter-resistant cable XS2H-D421-□80-SA

*1. 40mm for XS2H-D421-□80-F
*2. 60mm for XS2H-D421-□80-F

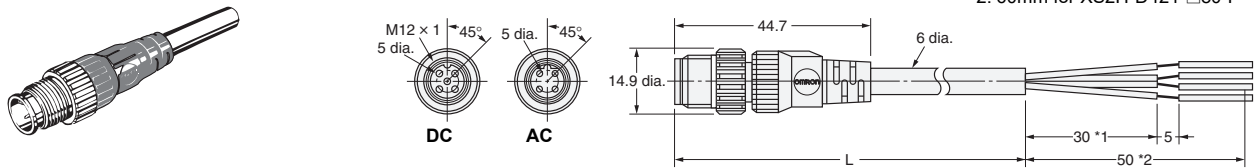

Wiring Diagram

Two-cores

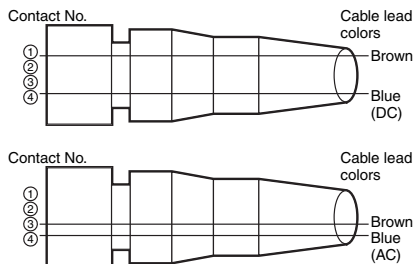

Three-cores

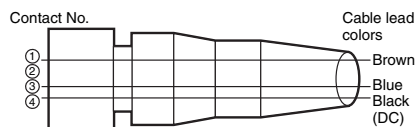

Four-cores

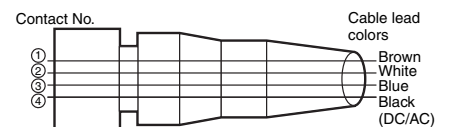

Straight (5 poles)

Standard cable XS2H-D521-□G0-A (For DC)

Note:
Use the XS2F-D521-□G0-A in combination with the XS2H-D521-□G0-A.

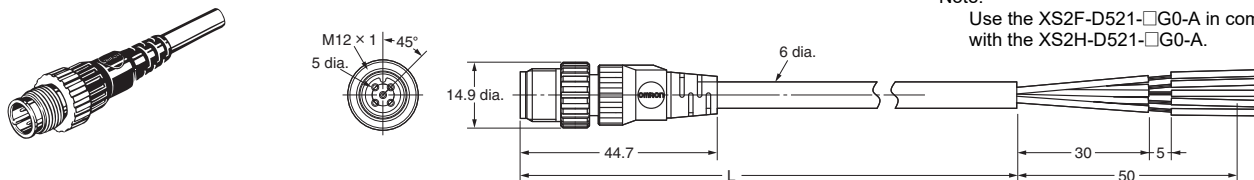

Wiring Diagram

Five-cores



XS2 Sensor I/O Connectors on Cables (8-pole)

Ordering Information

| Connector type | Cable connection direction | Number of cores | Cable length L (m) | Applicable wire diameter | Model | UL |
|------------------------------------|----------------------------|-----------------|--------------------|--------------------------|-----------------|--------------------------------------|
| Panel-mounting Plug | — | — | — | AWG22 to 28 | XS2M-D824-4 | — |
| Panel-mounting socket | | | | | XS2P-D821-2 | |
| Plug on one cable end | Straight | 8 | 0.3 | — | XS2H-D821-AH0-C | UL 2238 certified (File No. E207683) |
| | | | 1 | | XS2H-D821-CH0-C | |
| Socket on one cable end | | | 2 | | XS2F-D821-DH0-C | |
| | | | 5 | | XS2F-D821-GH0-C | |
| Plug and socket on both cable ends | | | 2 | | XS2W-D821-DH1-C | |
| | | | 5 | | XS2W-D821-GH1-C | |

Note: Ask your OMRON representative about other cable lengths.
Ask your OMRON representative about PVC robot cable models (-R).

Ratings and Specifications

| | |
|-------------------------------------|--|
| Rated current | 1.5 A |
| Rated voltage | 36 VDC |
| Contact resistance | 40 mΩ max. (at 20 mVDC max. and 100 mA max.) |
| Insulation resistance | 1,000 MΩ min. (at 500 VDC) |
| Dielectric strength | 1,000 VAC for 1 min (leakage current: 1 mA max.) |
| Degree of protection | IP67 |
| Insertion tolerance | 200 times min. |
| Ambient operating temperature range | -25 to 70°C |

Materials and Finish

| | |
|--------------------------------|---|
| Contacts | Brass, gold plating |
| Thread Bracket, body, M16 nuts | Brass/nickel plated |
| Pin block | PBT resin, light gray |
| Cover *1 | Soft PBT resin |
| Seal rubber and O-ring *2 | Rubber |
| Cable | Standard cable (8 core, shielded) 6 mm dia. AWG24 |

*1. XS2F/XS2H/XS2W only.
*2. O-rings are on sockets only.

Pins and Cable Lead Colors

| XS2F/XS2H/XS2W cable lead colors | Pin No. | | | | | | | |
|----------------------------------|---------|-------|-------|--------|------|------|------|--------|
| | 1 | 2 | 3 | 4 | 5 | 6 | 7 | 8 |
| | White | Brown | Green | Yellow | Gray | Pink | Blue | Shield |

Wiring

Wiring Example

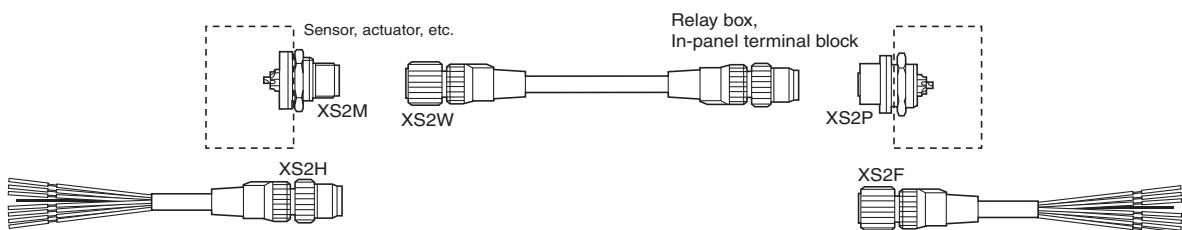

Dimensions

Plug on One Cable End (M12)
XS2H

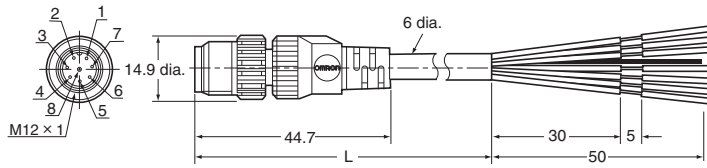
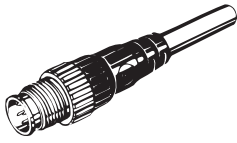

Socket on One Cable End (M12)
XS2F

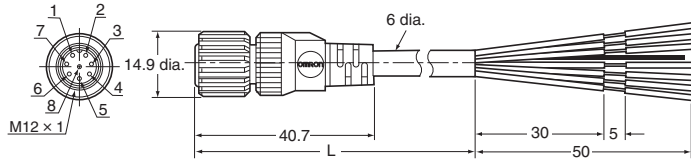
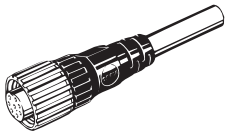

Socket and Plug on Both Cable Ends (M12)
XS2W

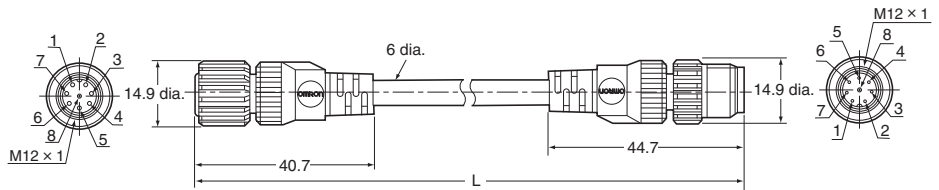
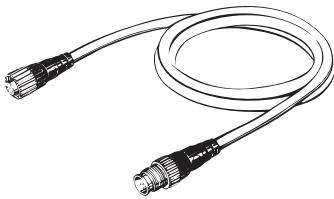

Panel-mounting Socket (M12)
Rear Lock Model
XS2P-D821-2 (with Solder Cup Pins)

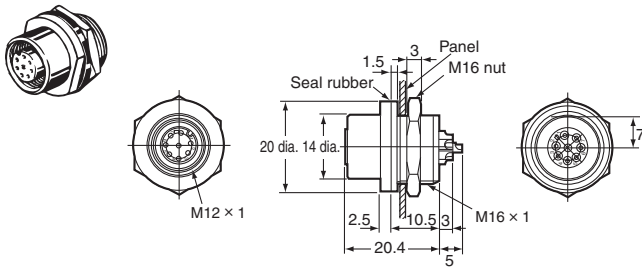

Panel-mounting Plug (M12)
Front Lock Model
XS2M-D824-4 (with Solder Cup Pins)

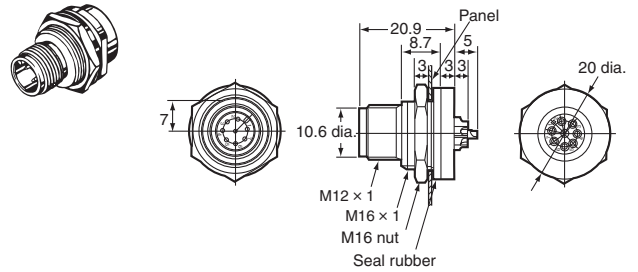

Panel-mounting Socket (M12)
Front Lock Model
XS2P-D822-2 (with Solder Cup Pins)

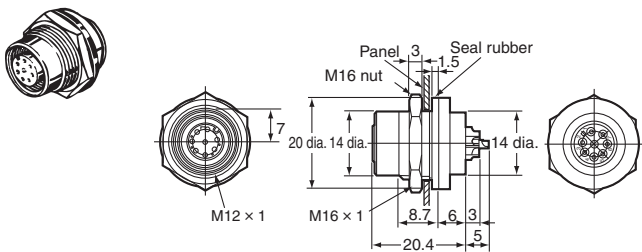

Panel Cutout

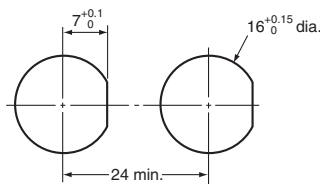

Connector Terminal Numbers (from Connection Side)

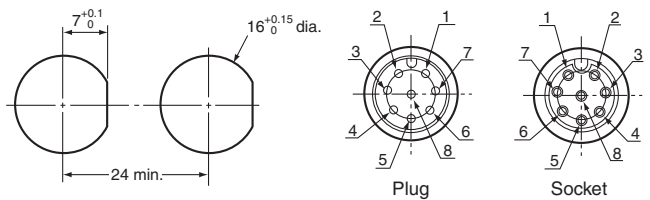

Note: 1. Mounting panel thickness: 1 to 4 mm.
2. Applicable core wire size for solder cup pins: 0.5 mm² max.
3. The M16 nut and seal rubber are included.

XS2G Crimping/Soldering Plug Assemblies

Ordering Information

| Suitable cable (mm) | Core conductor size (mm ²) | Suitable sheath material | Cable connection direction | Connection method | DC | AC | UL |
|----------------------|--|--------------------------|----------------------------|------------------------|------------------------|----------------|--------------------------------------|
| | | | | | Model | Model | |
| 6 dia. (5 to 6 dia.) | 0.18 to 0.3 0.5 to 0.75* | PVC, PE, PUR | Straight | Crimping | XS2G-D4C1 | XS2G-A4C1 | UL 2238 certified (File No. E207683) |
| | Soldering | | | XS2G-D421 XS2G-D422 | XS2G-A421 — | | |
| 4 dia. (4 to 5 dia.) | 0.18 to 0.3 0.5 to 0.75* | | Straight | Crimping | XS2G-D4C3 | XS2G-A4C3 | |
| | 0.5 max. | | | Soldering | XS2G-D423 XS2G-D424 | XS2G-A423 — | |
| 3 dia. (3 to 4 dia.) | 0.18 to 0.3 0.5 to 0.75* | | Straight | Crimping | XS2G-D4C5 | XS2G-A4C5 | |
| | 0.5 max. | | | Soldering | XS2G-D425 XS2G-D426 | XS2G-A425 — | |

*There are two types of contacts.

Note: Crimping plug pins are sold separately.

Use a cable of mentioning. If you do not use one of these cables, there is a possibility that the performance can't be met.

Dimensions

(Unit: mm)

Straight Connectors

XS2G-□4C□ (Crimping Model)

XS2G-□42□ (Soldering Model)

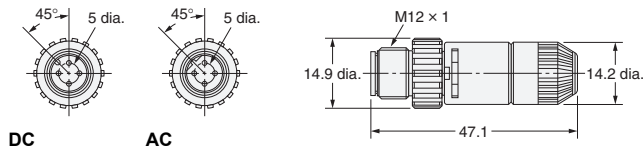
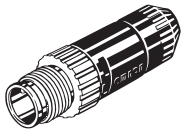

Right-angle

XS2G-D42□ (Soldering Model)

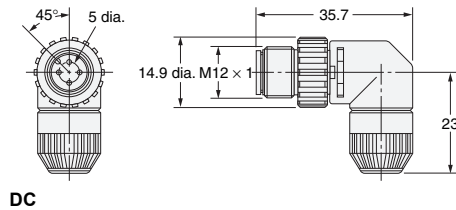
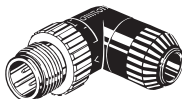

XS2U Crimping Pin for XS2G

Ordering Information

| Suitable core size (mm ²) | Model |
|---------------------------------------|-----------|
| 0.18 to 0.3 | XS2U-3121 |
| 0.5 to 0.75 | XS2U-3122 |

Dimensions

(Unit: mm)

XS2U-312□

* A special tool must be used for crimping. For details, refer to page 33.

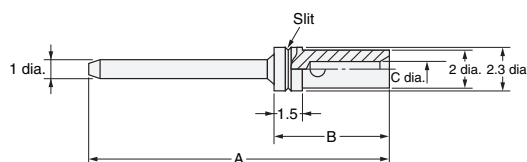

Dimensions

| Model | Suitable core size (mm ²) | Dimension (mm) | | | No. of slits |
|-----------|---------------------------------------|----------------|-----|-----|--------------|
| | | A | B | C | |
| XS2U-3121 | 0.18 to 0.3 | 20.0 | 6.1 | 0.8 | 1 |
| XS2U-3122 | 0.5 to 0.75 | 20.1 | 6.2 | 1.3 | 0 |

XS2C Crimping/Soldering Socket Assemblies

Ordering Information

| Suitable cable (mm) | Core conductor size (mm ²) | Suitable sheath material | Cable connection direction | Connection method | DC | AC | UL |
|----------------------|---|--------------------------|----------------------------|-------------------|-----------|-----------|--------------------------------------|
| | | | | | Model | Model | |
| 6 dia. (5 to 6 dia.) | 0.18 to 0.3 0.5 to 0.75* 0.5 max. | PVC, PE, PUR | Straight | Crimping | XS2C-D4C1 | XS2C-A4C1 | UL 2238 certified (File No. E207683) |
| | | | | Soldering | XS2C-D421 | XS2C-A421 | |
| | Right-angle | | Crimping | XS2C-D4C2 | XS2C-A4C2 | | |
| | | | Soldering | XS2C-D422 | XS2C-A422 | | |
| 4 dia. (4 to 5 dia.) | 0.18 to 0.3 0.5 to 0.75* 0.5 max. | | Straight | Crimping | XS2C-D4C3 | XS2C-A4C3 | |
| | | | | Soldering | XS2C-D423 | XS2C-A423 | |
| | Right-angle | | Crimping | XS2C-D4C4 | XS2C-A4C4 | | |
| | | | Soldering | XS2C-D424 | XS2C-A424 | | |
| 3 dia. (3 to 4 dia.) | 0.18 to 0.3 0.5 to 0.75* 0.5 max. | Straight | Crimping | XS2C-D4C5 | XS2C-A4C5 | | |
| | | | Soldering | XS2C-D425 | XS2C-A425 | | |
| | Right-angle | Crimping | XS2C-D4C6 | XS2C-A4C6 | | | |
| | | Soldering | XS2C-D426 | XS2C-A426 | | | |

*There are two types of contacts.

Note: Crimping plug contacts are sold separately.

Use a cable of mentioning. If you do not use one of these cables, there is a possibility that the performance can't be met.

Dimensions

(Unit: mm)

Straight Connectors

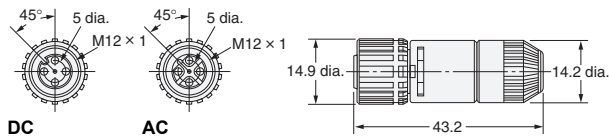
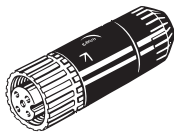

Right-angle Connectors

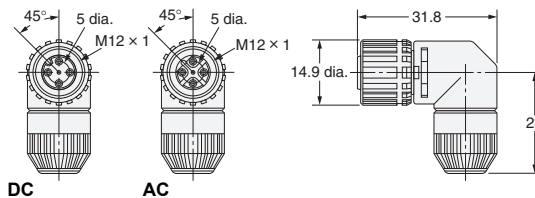

XS2U Crimping Pin for XS2C

Ordering Information

| Suitable core size (mm ²) | Model |
|---------------------------------------|-----------|
| 0.18 to 0.3 | XS2U-2221 |
| 0.5 to 0.75 | XS2U-2222 |

Dimensions

(Unit: mm)

Socket Pin

* A special tool must be used for crimping. For details, refer to page 33.

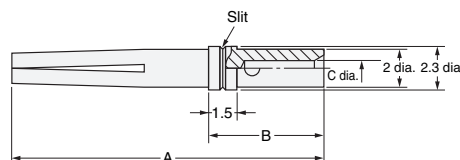

Dimensions

| Model | Suitable core size (mm ²) | Dimension (mm) | | | No. of slits |
|-----------|---------------------------------------|----------------|-----|-----|--------------|
| | | A | B | C | |
| XS2U-2221 | 0.18 to 0.3 | 16.7 | 6.1 | 0.8 | 1 |
| XS2U-2222 | 0.5 to 0.75 | 16.8 | 6.2 | 1.3 | 0 |

XS2G Screw-on Plug Assemblies

Ordering Information

| No. of poles | Suitable cable (mm) | Core conductor size (mm ²) | Suitable sheath material | Straight connectors (for DC) | Right-angle connectors (for DC) | UL |
|--------------|----------------------|--|--------------------------|------------------------------|---------------------------------|---|
| | | | | Model | Model | |
| 5 | 8 dia. (7 to 8 dia.) | 0.18 to 0.75 | PVC, PE, PUR | XS2G-D5S7 | — | UL 2238 certified (File No. E207683) |
| | 7 dia. (6 to 7 dia.) | | | XS2G-D5S9 | — | |
| | 6 dia. (5 to 6 dia.) | | | XS2G-D5S1 | XS2G-D5S2 | |
| 4 | 8 dia. (7 to 8 dia.) | | | XS2G-D4S7 | — | |
| | 7 dia. (6 to 7 dia.) | | | XS2G-D4S9 | — | |
| | 6 dia. (5 to 6 dia.) | | | XS2G-D4S1 | XS2G-D4S2 | |
| | 4 dia. (4 to 5 dia.) | | | XS2G-D4S3 | XS2G-D4S4 | |
| | 3 dia. (3 to 4 dia.) | | | XS2G-D4S5 | XS2G-D4S6 | |

Note: XS2G Screw-on Plugs cannot be connected to side by side to the CN1 and CN2 connectors of XS2R Y-Joint Sockets/Plugs.
Use a cable of mentioning. If you do not use one of these cables, there is a possibility that the performance can't be met.

Dimensions

(Unit: mm)

Straight Connectors

Applicable Cable Outer Diameter: 8 mm

XS2G-D5S7 (5poles)

XS2G-D4S7 (4 poles)

Applicable Cable Outer Diameter: 7 mm

XS2G-D5S9 (5poles)

XS2G-D4S9 (4 poles)

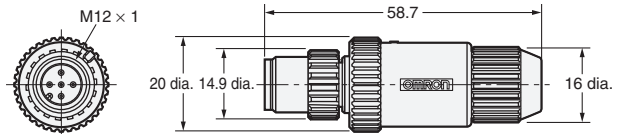
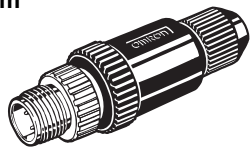

Straight Connectors

Applicable Cable Outer Diameter: 6 mm

XS2G-D5S1 (5poles)

XS2G-D4S1 (4 poles)

Applicable Cable Outer Diameter: 4 mm

XS2G-D4S3 (4 poles)

Applicable Cable Outer Diameter: 3 mm

XS2G-D4S5 (4 poles)

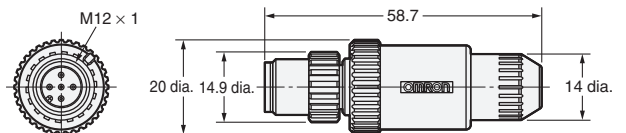
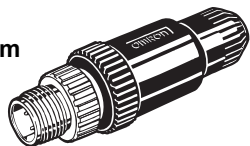

Right-angle Connectors

Applicable Cable Outer Diameter: 6 mm

XS2G-D5S2 (5poles)

XS2G-D4S2 (4 poles)

Applicable Cable Outer Diameter: 4 mm

XS2G-D4S4 (4 poles)

Applicable Cable Outer Diameter: 3 mm

XS2G-D4S6 (4 poles)

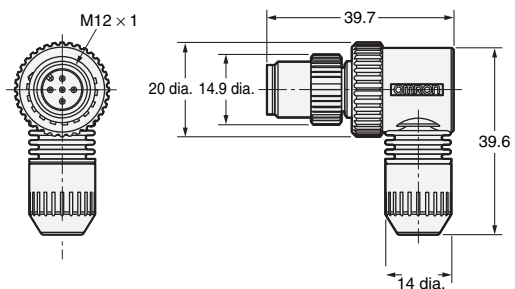
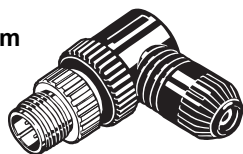

XS2C Screw-on Socket Assemblies

Ordering Information

| No. of poles | Suitable cable (mm) | Core conductor size (mm ²) | Suitable sheath material | Straight connectors (for DC) | Right-angle connectors (for DC) | UL |
|--------------|----------------------|--|--------------------------|------------------------------|---------------------------------|---|
| | | | | Model | Model | |
| 5 | 8 dia. (7 to 8 dia.) | 0.18 to 0.75 | PVC, PE, PUR | XS2C-D5S7 | — | UL 2238 certified (File No. E207683) |
| | 7 dia. (6 to 7 dia.) | | | XS2C-D5S9 | — | |
| | 6 dia. (5 to 6 dia.) | | | XS2C-D5S1 | XS2C-D5S2 | |
| 4 | 8 dia. (7 to 8 dia.) | | | XS2C-D4S7 | — | |
| | 7 dia. (6 to 7 dia.) | | | XS2C-D4S9 | — | |
| | 6 dia. (5 to 6 dia.) | | | XS2C-D4S1 | XS2C-D4S2 | |
| | 4 dia. (4 to 5 dia.) | | | XS2C-D4S3 | XS2C-D4S4 | |
| | 3 dia. (3 to 4 dia.) | | | XS2C-D4S5 | XS2C-D4S6 | |

Note: Use a cable of mentioning. If you do not use one of these cables, there is a possibility that the performance can't be met.

Dimensions

(Unit: mm)

Straight Connectors

Applicable Cable Outer Diameter: 8 mm

XS2C-D5S7 (5 poles)

XS2C-D4S7 (4 poles)

Applicable Cable Outer Diameter: 7 mm

XS2C-D5S9 (5 poles)

XS2C-D4S9 (4 poles)

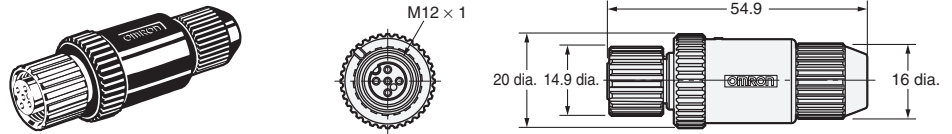

Straight Connectors

Applicable Cable Outer Diameter: 6 mm

XS2C-D5S1 (5 poles)

XS2C-D4S1 (4 poles)

Applicable Cable Outer Diameter: 4 mm

XS2C-D4S3 (4 poles)

Applicable Cable Outer Diameter: 3 mm

XS2C-D4S5 (4 poles)

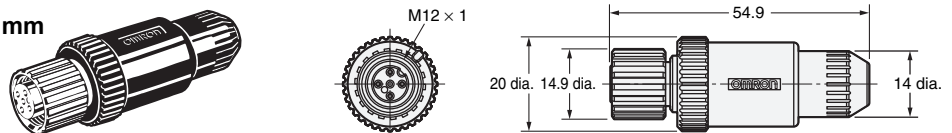

Right-angle Connectors

Applicable Cable Outer Diameter: 6 mm

XS2C-D5S2 (5 poles)

XS2C-D4S2 (4 poles)

Applicable Cable Outer Diameter: 4 mm

XS2C-D4S4 (4 poles)

Applicable Cable Outer Diameter: 3 mm

XS2C-D4S6 (4 poles)

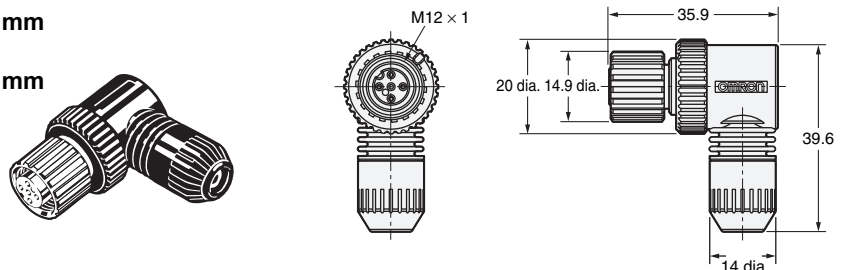

XS2C/XS2G Safety Precautions

Assembly Procedure for XS2C/XS2G Connector Assemblies

(1) Connector and Cable Diameters

- Connectors for 8, 7, 6, 4, and 3 mm diameter Cables (i.e., Cables that are 7 to 8, 6 to 7, 5 to 6, 4 to 5, and 3 to 4 mm in diameter respectively) are available.
- When assembling a Connector used with a cable, make sure that the external diameter of the Connector is suited to that of the cable.
- A waterproof bushing for 6/7 mm diameter Cable has no stripe, that for 8/4 mm diameter Cable has a single stripe, and that for 3 mm diameter Cable has two stripes.

(2) Component Insertion

Crimping/Soldering Connectors

Straight Connectors

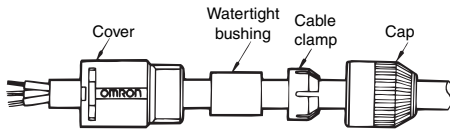

Right-angle Connectors

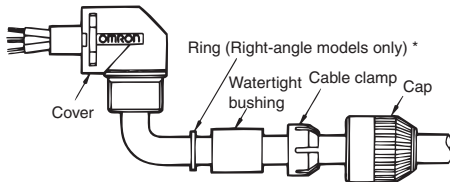

*A ring is not required for Screw-on Connectors.

- As shown in the above illustration, connect the above components to the Cable with its end processed.

Screw-on Connectors

Confirm that you have all of the required parts.

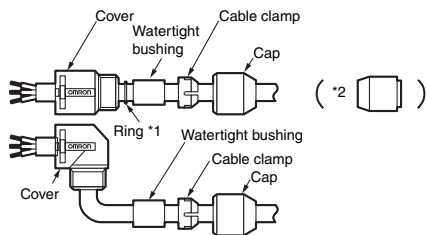

Insulation caps and insulation tubes are included with 5-pole Connectors (XS2C-D5S□ and XS2G-D5S□).

- *1. Rings are not required with 7-mm and 8-mm cables.
- *2. Insert the waterproof bushing for 7-mm and 8-mm cables in the direction shown in the diagram.

(3) Wiring (Dressing the Cable Ends)

Soldering Connectors

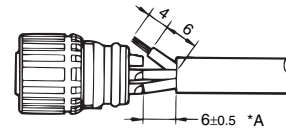

- Strip 10 mm of the Cable sheath and 4 mm of each core.
- Before soldering cores and solder cup pins together, solder-coat each of them.
- The following conditions are recommended for soldering each solder cup pin.
Soldering temperature: 350±5°C
Soldering period: 3±1 s
- The length marked *A should be 6.5 mm max., otherwise the proper degree of protection of the connector will not be maintained.

Crimping Connectors

Crimping

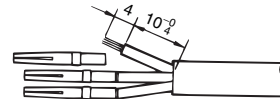

- Strip 14 mm of the Cable sheath and 4 mm of each core.
- Make sure that each core is not damaged and its end strands are not spread out.
- Mount the XY2F-0003 Locator to XY2F-0002 Crimp Tool, both of which are sold separately, and set the selector dial of the Crimp Tool to 8.
- After mounting the crimping pins to the Locator, fully insert the cores to the crimping pins.
- Squeeze the handle of the Crimp Tool to press-fit the cores to the crimping pins.
(Squeeze the handle firmly until the handle automatically returns to the release position.)

Wiring

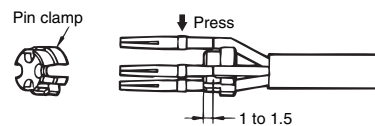

- After press-fitting the cores to the pins, insert the pins into the pin clamp as shown in the illustration. Then make sure that the lead colors correspond to the pin clamp numbers that are identical to the connector pin numbers.

Insertion

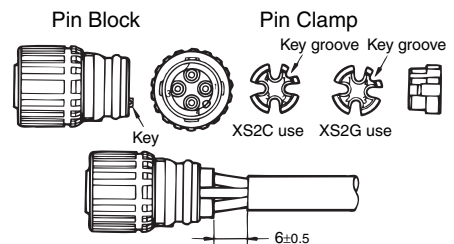

- Tentatively insert the pins to the pin block holes so that the key on the pin block will coincide with the key groove on the pin clamp. Then insert the cable along with the pin clamp.

Screw-on Connectors

Dressing the Cable End

• **Four-pole Connectors**

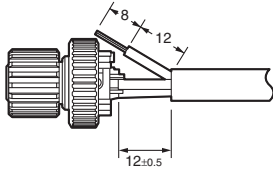

- Loosen the screws on pins 1 to 4 and insert the cores according to the pin numbers.

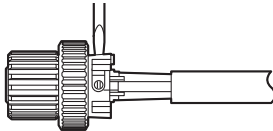

- Use the dedicated Screwdriver (XW4Z-00B)* and tighten the screws securely so that the cores do not pull out. (0.15 to 0.2 N·m)

• **Five-pole Connectors**

- Strip the cable sheath for a total of 15 mm and strip the core covering for 8 mm for the core to connect to pin 5.

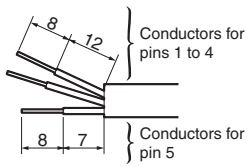

- Connect the core to pin 5 (in the center) first.
- Insert the core from the side of the hold with the tab and tighten the screw securely (tightening torque: Pins 1 to 4: 0.15 to 0.2 N·m, Pin 5: 0.03 to 0.05 N·m), and then cut off the excess wire with wire cutters.

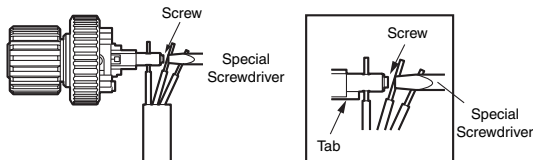

- Bend the cable as shown below, attached the enclosed insulation cap, and then strip the other cores.

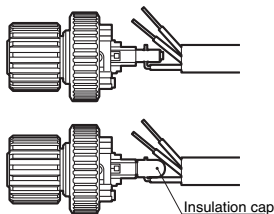

- Connect the cores to pins 1 to 4.

Connecting Shielded Cables to Five-pole Connectors

- Place the insulation tub on the drain line of the shield and connect it to the terminal.
- Tighten the screw and then check visually to see if there is insulation between the cores.

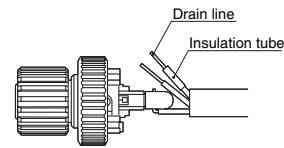

*When tightening the screws, use the dedicated XW4Z-00B Screwdriver that matches with the screw-slot dimensions.



(4) Inserting Pin Block

Pin block (Soldering Model)

Cover (Straight Model)

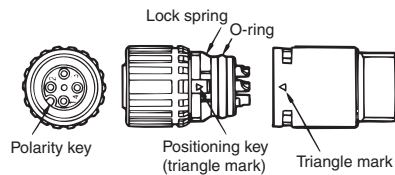

(Crimping Model)

(Right-angle Model)



- Mount the cover to the pin block so that the triangle mark on the pin block will coincide with the triangle mark on the cover.
- If the cover is used for a Right-angle model, the relationship between the position of the polarity key on the engaged side and cable connection direction will be determined by the direction in which the positioning key is inserted into the cover, which can be rotated by 90°.
- Fully insert the positioning key until the positioning key is hidden by the casing.

Pin block (Screw-on Connectors)

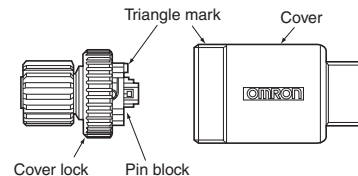

- Align the triangular marks on the pin block and cover and insert the pin block into the cover.
- Press them together firmly until the pin block does not come out of the cover. (0.39 to 0.49 N·m)

(5) Mounting Cap

- After mounting the cover to the pin block and the cover snaps into place, tighten the cap securely by hand (0.39 to 0.49 N·m)

Note: If the cap is not tighten securely enough, the degree of protection (IP67) may not be maintained or vibration may cause the cap to become loose. Do not tighten the cap with pliers or similar tools; they may damage the cap.

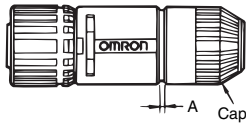

- After fully tightening the cap, length A should be approximately one of the following according to the cable external diameter and the Connector model. (Use these as a guide.)

| External diameter of applicable cable | Cable external diameter (mm) | | | |
|---------------------------------------|------------------------------|------|------|------|
| | 6 mm | 5 mm | 4 mm | 3 mm |
| For 6-mm-dia. cable | 1 | 0 | — | — |
| For 4-mm-dia. cable | — | 2 | 1 | — |
| For 3-mm-dia. cable | — | — | 2 | 1 |

(6) After Assembly

- Confirm the insulation between cores after completing assembly.

Recommended Cables

When connecting a commercially available cable to a connector assembly, use a cable with an outside diameter of 3 to 6 mm and core conductor sizes of 0.18 to 0.75 mm² for crimping connectors and 0.5 mm² maximum for soldering connectors.

Connector Arrangement

For safety, when constructing a connection system between a Sensor and panel with a connector, make sure that the connector plug is on the Sensor side and the connector socket is on the panel side (i.e., the female pins are located on the power-supply side).

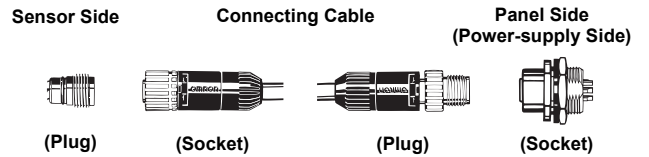

XS2P Panel-mounting Sockets for Terminal Boxes

Ordering Information

| No. of poles | Lock method | Pin shape* | Applicable wire diameter | DC | AC | UL |
|--------------|-------------|----------------|--------------------------|--------------------|--------------------|---|
| | | | | Model | Model | |
| 4 | Rear lock | Solder cup pin | AWG20 to 28 | XS2P-D421-2 | XS2P-A421-2 | UL 2238 certified (File No. E207683) |
| | Front lock | Solder cup pin | | XS2P-D422-2 | XS2P-A422-2 | |
| | | DIP pin | | XS2P-D422-1 | — | |
| 5 | Front lock | Solder cup pin | | XS2P-D522-2 | — | — |
| | | DIP pin | | XS2P-D522-1 | — | |

*The solder cup pin is for wire mounting, and the DIP pin is for PCB mounting. Soldering is required for both pins.

Dimensions

(Unit: mm)

Rear Lock Model

XS2P-□421-2 (with Solder Cup Pins)

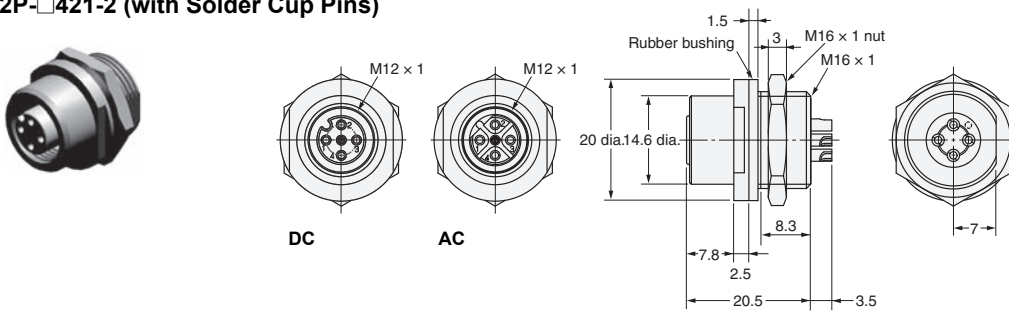

Front Lock Model

XS2P-□422-1 (with DIP Pins)

XS2P-□422-2 (with Solder Cup Pins)

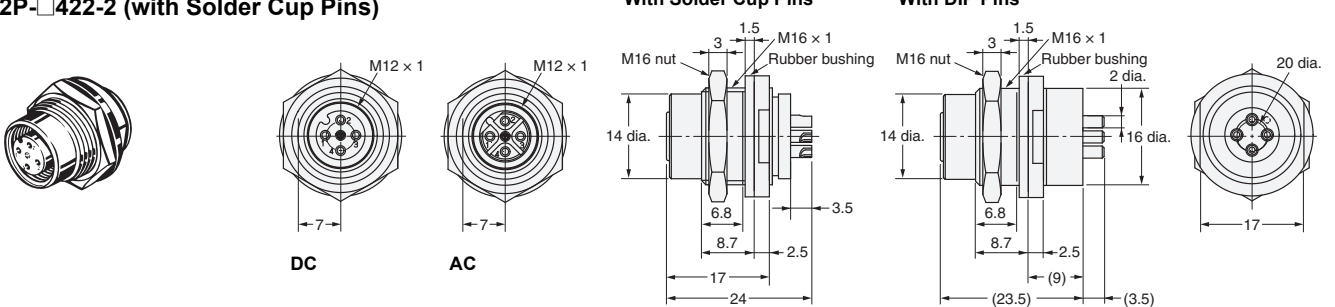

Front Lock Model

XS2P-D522-1 (with DIP Pins)

XS2P-D522-2 (with Solder Cup Pins)

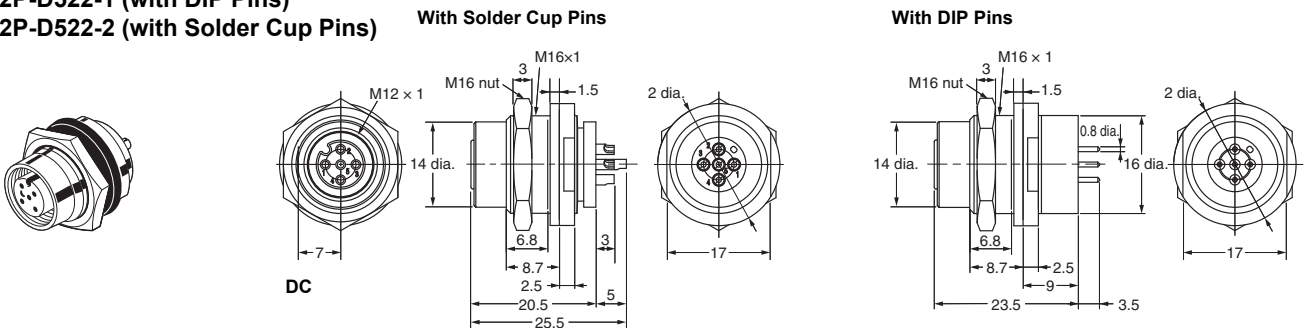

Panel Cutout

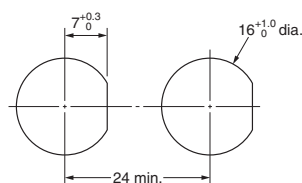

Note: The panel thickness is 1 to 4 mm.

PCB-mounting Dimensions With DIP Pins

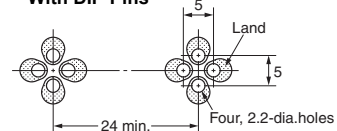

XS2R Y-Joint Plug/Socket Connectors

Ordering Information

| Cable | Connector | DC | | UL |
|---------------|-------------------------------|--------------------|-----------------|---|
| | | Cable length L (m) | Model | |
| With cable | Connectors on both cable ends | 0.5 | XS2R-D426-B11-F | UL 2238 certified (File No. E207683) |
| | | 1 | XS2R-D426-C11-F | |
| | | 2 | XS2R-D426-D11-F | |
| | | 3 | XS2R-D426-E11-F | |
| | Connector on one cable end | 2 | XS2R-D426-D10-F | |
| | | 5 | XS2R-D426-G10-F | |
| Cable | Connector | DC | | UL |
| | | Cable length L (m) | Model | |
| Without cable | Connectors on both cable ends | — | XS2R-D426-1 | — |
| | | | XS2R-D426-5 | |
| | | | XS2R-D426-81 | |
| | | | XS2R-D426-82 | |

Note: XS2G Screw-on Plugs cannot be connected side-by-side to the CN1 and CN2 connectors.
Consider using a crimping or soldering model instead. Refer to page 18 for details.

Dimensions

(Unit: mm)

Connectors on Both Cable Ends (Y-Joint Plug/Socket) XS2R-D426-□11-F

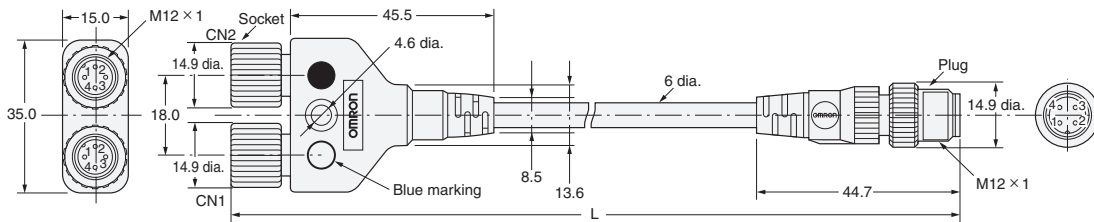

Wiring Diagram

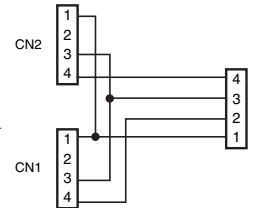

Connectors on One Cable End (Y-Joint Socket) XS2R-D426-□10-F

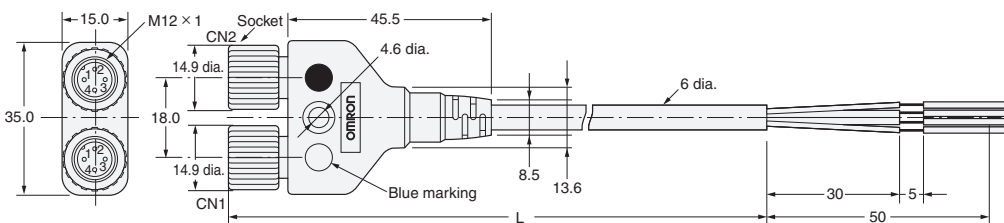

Wiring Diagram

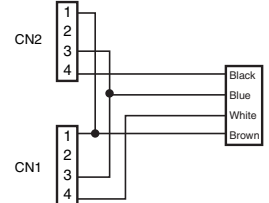

Y-Joint Plug/Socket without Cable XS2R-D426-1

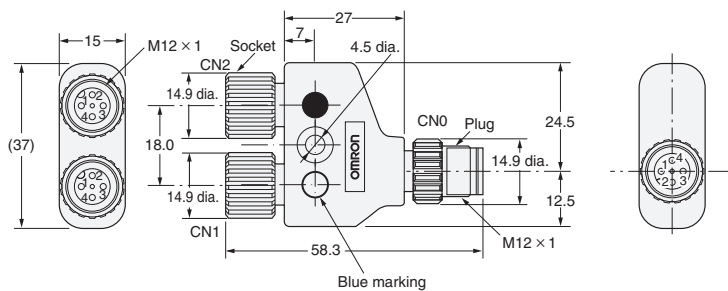

Wiring Diagram

XS2R-D426-1

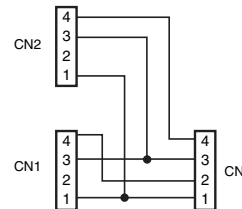

XS2R-D426-5

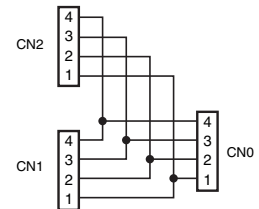

XS2R-D426-81

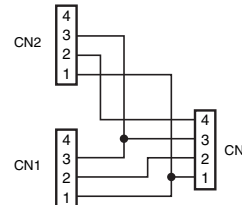

XS2R-D426-82

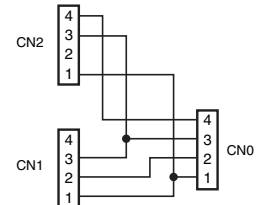

XS2R T-Joint Plug/Socket Connectors

Ordering Information

| Type | DC | UL |
|-------------------|-------------|--|
| | Model | |
| Aggregate model | XS2R-D422-1 | UL 2238 certified (File No. E207683) |
| | XS2R-D422-5 | |
| Bifurcated model | XS2R-D423-1 | |
| Daisy-chain model | XS2R-D424-1 | |

Dimensions

(Unit: mm)

Aggregate model
XS2R-D422-1
XS2R-D422-5

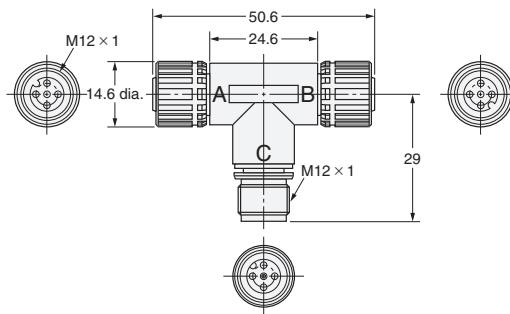
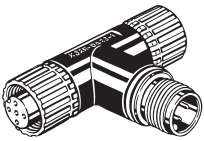

Wiring Diagram
XS2R-D422-1

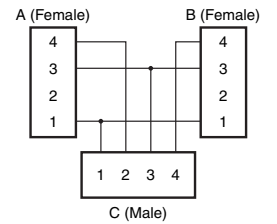

XS2R-D422-5

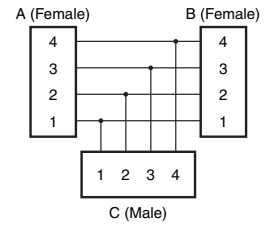

Bifurcated model
XS2R-D423-1

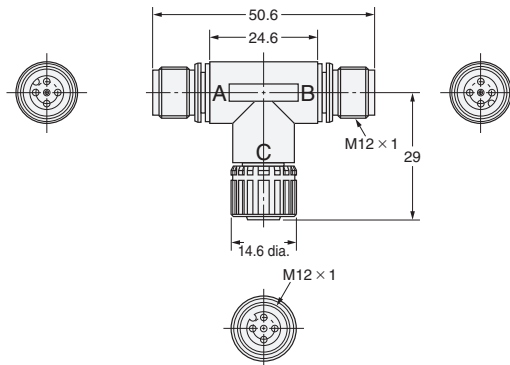
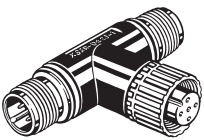

Wiring Diagram

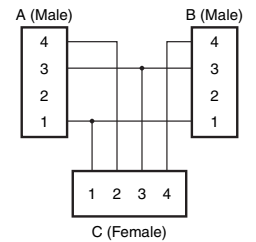

Daisy-chain model
XS2R-D424-1

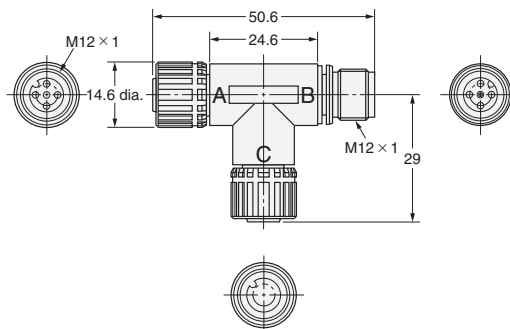

Wiring Diagram

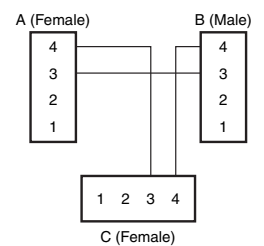

Features

XS2R Application Examples

XS2R-D422-1 (Aggregate Model)

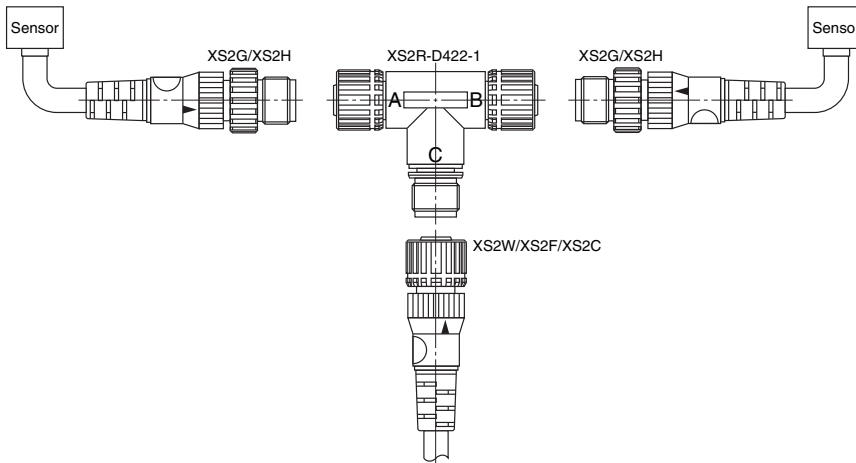

- A pair of Two-wire Sensors or Three-wire Sensors can be connected as shown in the illustration.
- The XS2R-D422-5 has feed through connections, thus working as a connector for the extension cable.

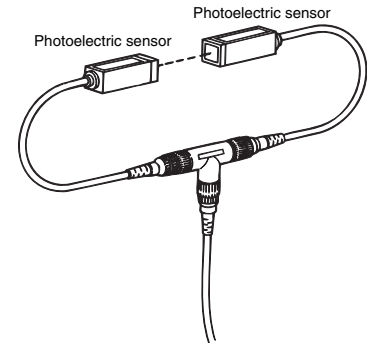

XS2R-D423-1 (Bifurcated Model)

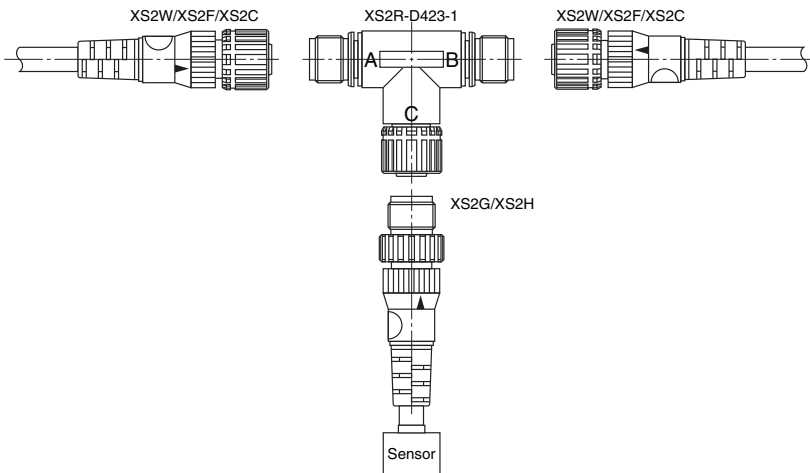

- Two or Three-wire Sensor signals can be bifurcated.

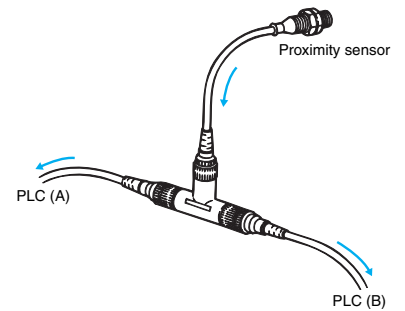

XS2R-D424-1 (Daisy Chain Model)

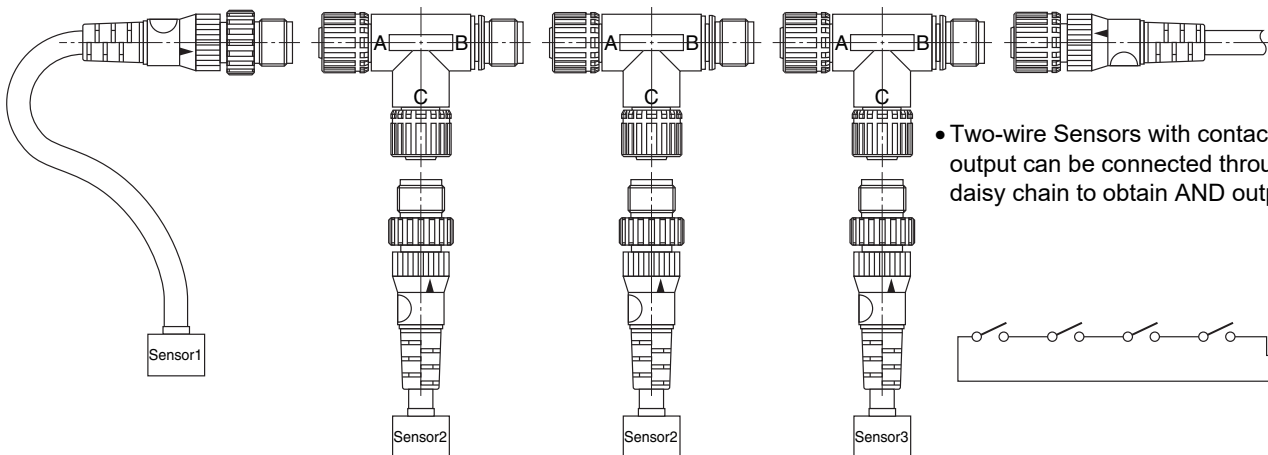

- Two-wire Sensors with contact output can be connected through a daisy chain to obtain AND output.

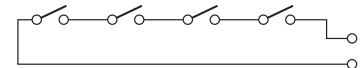

Safety Precautions

Precautions for Correct Use

Do not use the product in atmospheres or environments that exceed product ratings.

- Before using the XS2R for Sensors, make sure that the wiring of the Sensors and the internal connections of the XS2R are correct.

XS2M Sensor-embedded Plugs

Ordering Information

| No. of poles | Mounting method | Pin shape | Applicable wire diameter | DC | AC | UL |
|--------------|--------------------------------|----------------|--------------------------|------------------|------------------|---|
| | | | | Model | Model | |
| 4 | Embedded with screw threads | Solder cup pin | AWG22 to 28 | XS2M-D421 | XS2M-A421 | UL 2238 certified (File No. E207683) |
| | Embedded without screw threads | | | XS2M-D422 | XS2M-A422 | |

Dimensions

(Unit: mm)

Embedded with screw threads

XS2M-D421 (For DC)

XS2M-A421 (For AC)

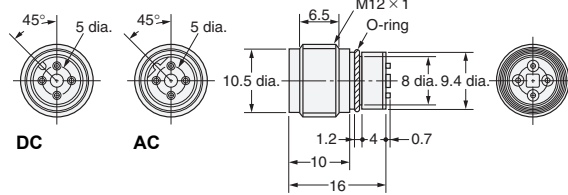

Mounting Dimensions

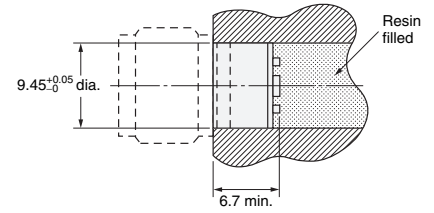

Note: After mounting, anchor the solder cup pins by injecting resin.

Embedded without screw threads

XS2M-D422 (For DC)

XS2M-A422 (For AC)

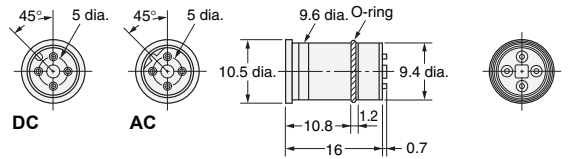

Mounting Dimensions

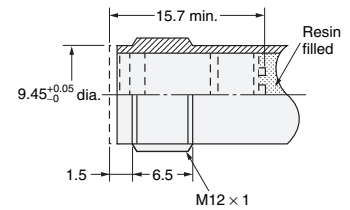

Note: After mounting, anchor the solder cup pins by injecting resin.

XS2M Panel-mounting Plugs

Ordering Information

Resin Body

| No. of poles | Mounting method | Pin shape*1 | Applicable wire diameter | DC | AC | UL |
|--------------|-----------------|----------------|--------------------------|--------------------|--------------------|---|
| | | | | Model | Model | |
| 4 | Flange-mounting | Solder cup pin | AWG22 to 28 | XS2M-D423 | XS2M-A423 | UL 2238 certified (File No. E207683) |
| | Screw-mounting | DIP pin | — | XS2M-D424-1 | XS2M-A424-1 | |
| | | Solder cup pin | AWG20 to 28 | XS2M-D424-2 | XS2M-A424-2 | |
| 5 | Screw-mounting | DIP pin | — | XS2M-D524-1 | — | |
| | | Solder cup pin | AWG20 to 28 | XS2M-D524-2 | — | |

Metal Body

| No. of poles | Mounting method | Pin shape*1 | Applicable wire diameter | DC | UL |
|--------------|-----------------|----------------|--------------------------|--------------------|----|
| | | | | Model | |
| 4 | Screw-mounting | DIP pin | — | XS2M-D424-3 | — |
| | | Solder cup pin | AWG20 to 28 | XS2M-D424-4 | |
| 5 | | DIP pin | — | XS2M-D524-3 | |
| | | Solder cup pin | AWG20 to 28 | XS2M-D524-4 | |

*1. The solder cup pin is for wire mounting, and the DIP pin is for PCB mounting.
Soldering is required for both pins.

Dimensions

(Unit: mm)

Flange-mounting XS2M-D423 (For DC) XS2M-A423 (For AC)

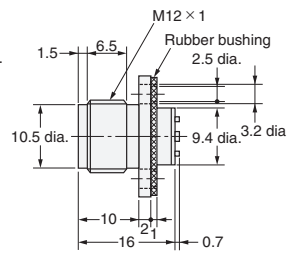
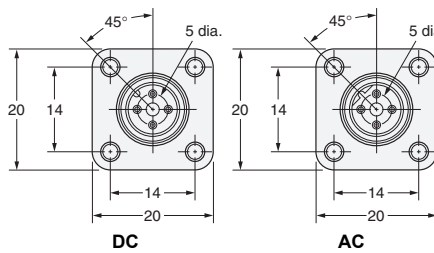

Panel Cutouts

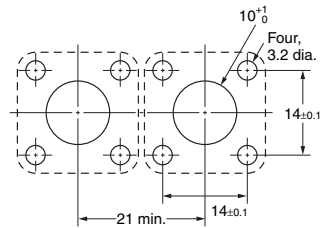

Screw-mounting XS2M-□424-1 DIP pin (Resin Body) XS2M-D424-3 DIP pin (Metal Body)

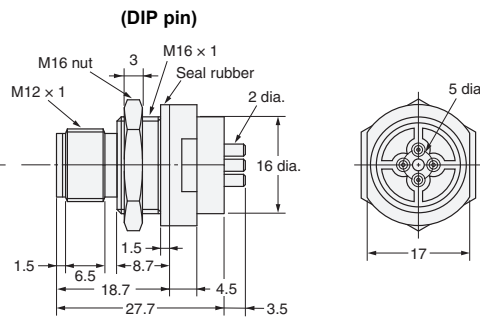
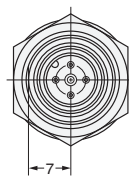
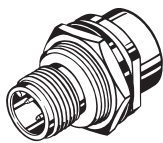

Panel Cutout

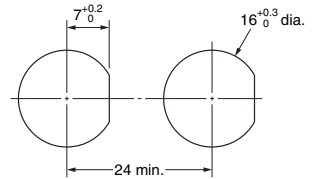

Note: The panel thickness is 1 to 4 mm.

PCB-mounting Dimensions

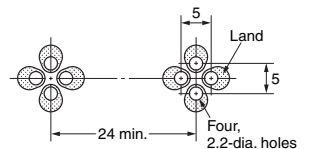

Screw-mounting

XS2M-□424-2 Solder Cup Pins (Resin Body)

XS2M-D424-4 Solder Cup Pins (Metal Body)

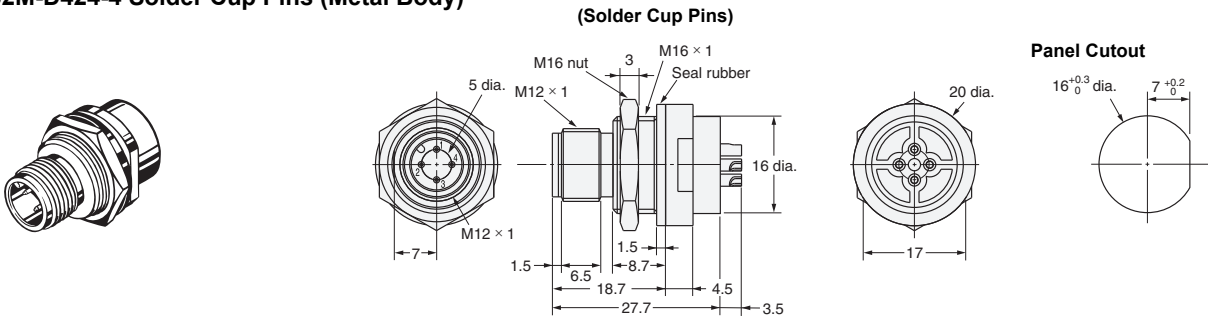

Screw-mounting

XS2M-D524-1 DIP pin (Resin Body)

Panel Cutout

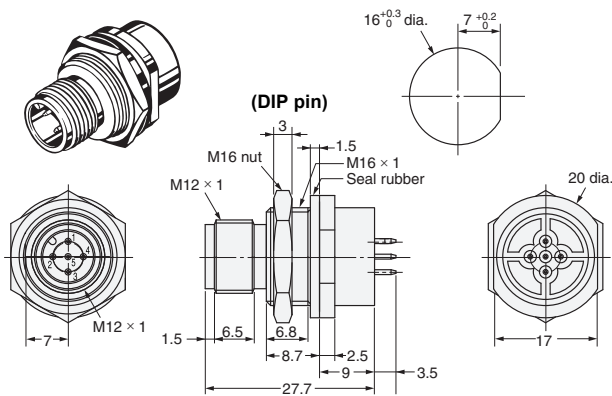

Screw-mounting

XS2M-D524-2 Solder Cup Pins (Resin Body)

Panel Cutout

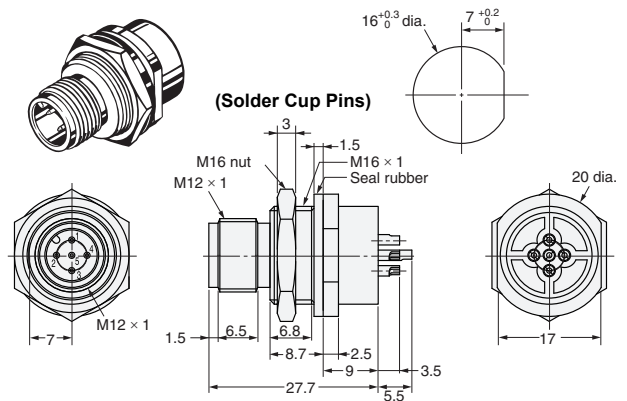

Screw-mounting

XS2M-D524-3 DIP pin (Metal Body)

Panel Cutout

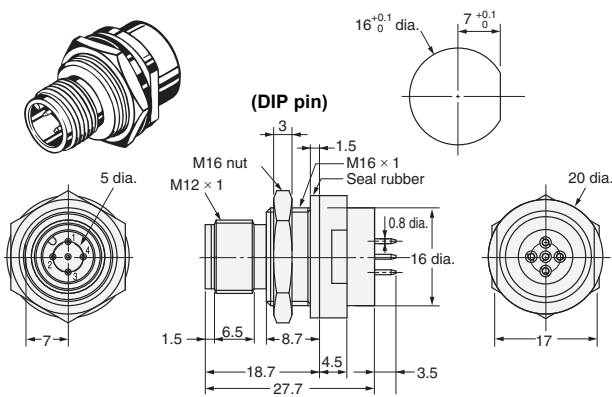

Screw-mounting

XS2M-D524-4 Solder Cup Pins (Metal Body)

Panel Cutout

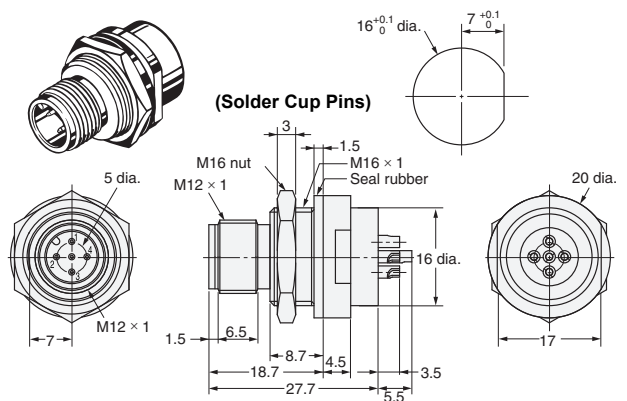

Common Accessories and Tools (Order Separately)

Ordering Information

Connector Covers

Waterproof Covers

XS2Z-11

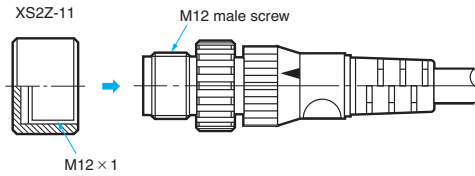
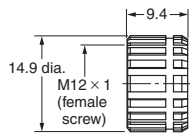

Application Example: XS2Z-11



You can use the Waterproof Cover when the connector is not connected to ensure an IP67 degree of protection. When mounting the Water-resistant Cover to a Connector, be sure to apply a torque range between 0.39 and 0.49 N·m to tighten the Water-resistant Cover.

XS2Z-22

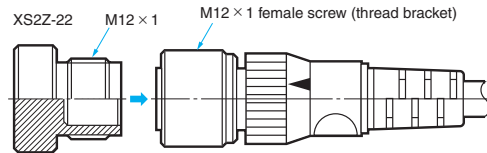
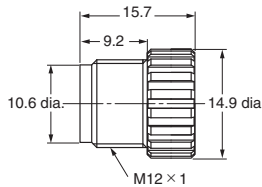

| Model | Materials | Suitable connector | |
|---------|--------------------------------|--|--------------------------------------|
| | | Model | Mounting portion |
| XS2Z-11 | Copper alloy/ Nickel plated | XS2G/XS2H/XS2M/XS2R/XS2W/XS5H/ XS5M/XS5W | M12 male screw |
| XS2Z-22 | | XS2C/XS2R/XS2F/XS2P/XS2W/XW3B/ XS5F/XS5W/XS5R/XS5P/XW3D | M12 female screw (thread bracket) |

Dust Covers

XS2Z-13

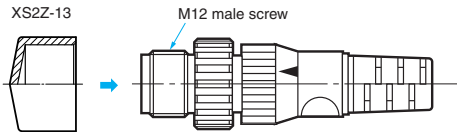

Application Example: XS2Z-13



XS2Z-15/XS2Z-14

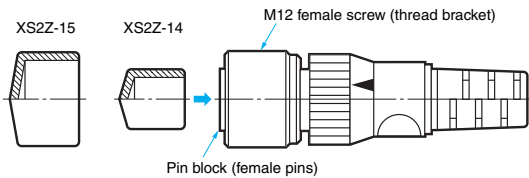

The Dust Cover is for dust prevention and does not ensure IP67 degree of protection. When mounting the Dust Cover to a Connector, be sure to press the Dust Cover onto the Connector until the Connector is fully inserted into the Dust Cover.

| Model | Materials | Suitable connector | |
|---------|--------------|--------------------------|--------------------------------------|
| | | Model | Mounting portion |
| XS2Z-13 | Rubber/black | XS2G/XS2H/XS2M/XS2R | M12 male screw |
| XS2Z-14 | | XS2C/XS2R/XS2F/XS2P/XW3B | Pin block (female pins) |
| XS2Z-15 | | | M12 female screw (thread bracket) |

Loosening-preventing C-ring

XS2Z-18



Application Example: XS2Z-18

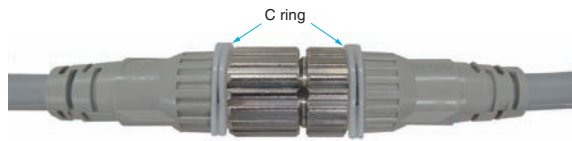

Note: Attach C-rings to both the plug and socket.

This C-ring prevents the M12 connector from becoming loose. When you attach the C-ring, press it securely between the thread bracket and cover.

| Model | Materials | Suitable connector |
|---------|-----------|--------------------|
| XS2Z-18 | POM | XS2F/H/W |

Sputter Protective Cover

XS2Z-31

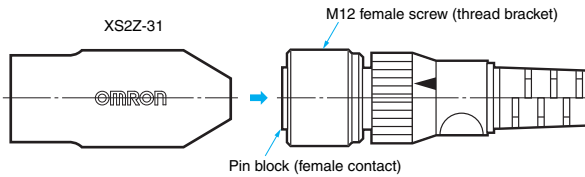
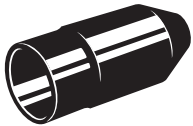

Application Example: XS2Z-31



The Sputter Protective Cover protects the connector from weld sputter. Make sure it covers the entire connector.

| Model | Materials | Suitable connector |
|---------|-----------------------|-----------------------------------|
| XS2Z-31 | Silicone rubber/black | XS5F/XS5H/XS5W/ XS2F/XS2H/XS2W |

Tools

Torque Wrench

XY2F-0004

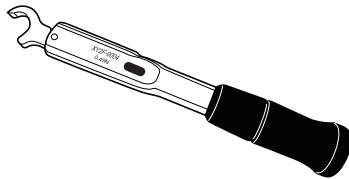

Crimp Tool

XY2F-0002

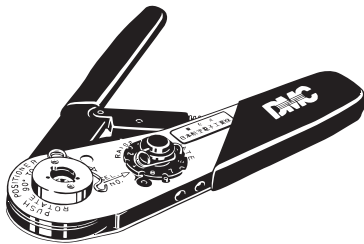

Locator

XY2F-0003

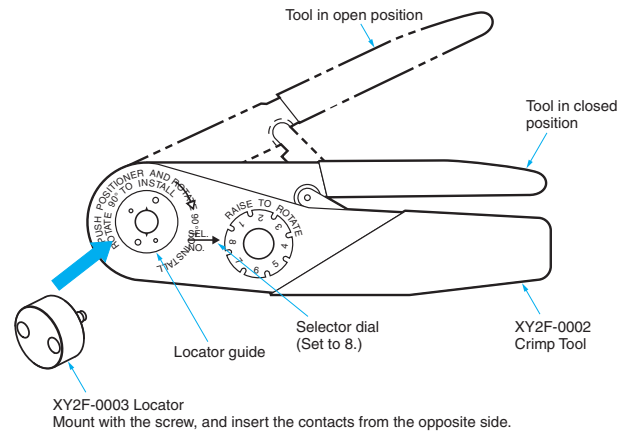

Use the Crimp Tool to crimp a cable core to the XS2U Crimping Pin used with the XS2C or XS2G Crimping Connector. Both the Crimp Tool and the optional Locator are required for use.

- The XY2F-0002 Crimp Tool is DMC's AFM8 (M22520/2-01).
- The XY2F-0003 Locator is a component for positioning crimp terminals. Use the screw provided to mount the Locator to the locator guide of the Crimp Tool.

Pin-block Extraction Tool

XY2F-0001

Use this tool to extract a Pin Block from the covers in order to make wiring changes or corrections after the cover has been mounted to the pin block for Connector Assemblies (XS2C/ XS2G, soldering/crimping).

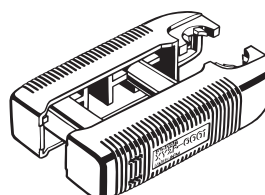

Safety Precautions

Extraction Procedure

(1) Disconnecting Components

- Disconnect all components on the cap side from the cover.

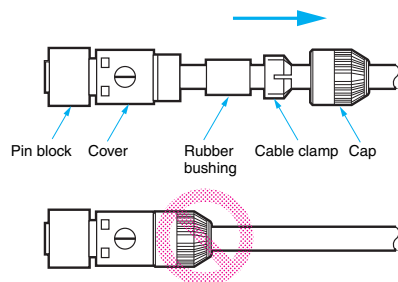

(2) Extracting Pin Block

- Insert the claws of the Tool into the four holes of the cover.

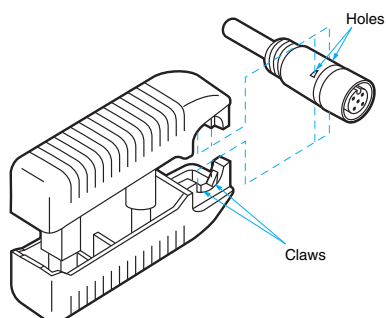

- Make sure that the pin block is outside the Tool.

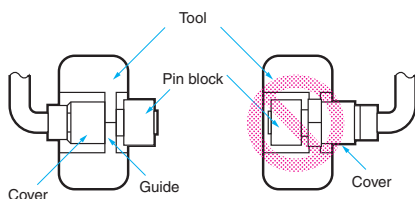

- Press the Tool so that the guides of the Tool are in close contact. Then pull the pin block straight.

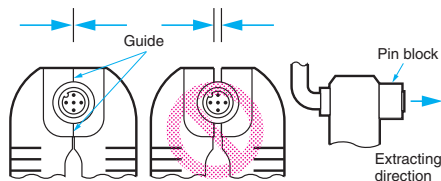

Precautions for Correct Use

- The pin block must not be extracted from the same Connector more than 3 times, otherwise the proper degree of protection of the pin block or Connector will not be maintained.
- Do not use the product in atmospheres or environments that exceed product ratings.

Tightening Cap (Connector Assemblies)

- 1) Do not use pliers to tighten caps, otherwise the caps may be damaged. Use your fingers to tighten the Connectors sufficiently. (0.39 to 0.49 N·m)
- 2) If caps are not tightened securely, the Connectors may not maintain their proper degree of protection (i.e., IP67) or the caps may become loose due to vibration.

Connector Connection and Disconnection

- When connecting or disconnecting Connectors, be sure to hold the Connectors by hand.
- Do not hold the cable when disconnecting Connectors.
- Connectors mating with sockets must be fully inserted into the mating sections. Tighten the thread bracket carefully so that the threads will not be damaged.
- Fully tighten thread bracket within a torque range between 0.39 and 0.49 N·m and be sure that the threads of the opposite parts are hidden by the thread bracket.
- When disconnecting Connectors, be sure to loosen the thread brackets first. Do not loosen the caps.
- Thread brackets must be loosened in the cutout direction.

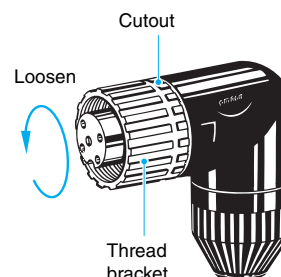

Degree of Protection

- Do not impose external force continuously on the joints of pin blocks and covers, otherwise the Connectors may not keep its proper degree of protection (i.e., IP67).
- The degree of protection of connectors (IP67) is not for a fully watertight structure. Do not use them underwater.
- Connectors are of resin mold construction. Do not impose excessive force on them.

Setup

- Do not make any cable bends near the base of the Unit.
- Any bends made must have a minimum radius of 40 mm.

Terms and Conditions Agreement

Read and understand this catalog.

Please read and understand this catalog before purchasing the products. Please consult your OMRON representative if you have any questions or comments.

Warranties.

(a) Exclusive Warranty. Omron's exclusive warranty is that the Products will be free from defects in materials and workmanship for a period of twelve months from the date of sale by Omron (or such other period expressed in writing by Omron). Omron disclaims all other warranties, express or implied.

(b) Limitations. OMRON MAKES NO WARRANTY OR REPRESENTATION, EXPRESS OR IMPLIED, ABOUT NON-INFRINGEMENT, MERCHANTABILITY OR FITNESS FOR A PARTICULAR PURPOSE OF THE PRODUCTS. BUYER ACKNOWLEDGES THAT IT ALONE HAS DETERMINED THAT THE PRODUCTS WILL SUITABLY MEET THE REQUIREMENTS OF THEIR INTENDED USE.

Omron further disclaims all warranties and responsibility of any type for claims or expenses based on infringement by the Products or otherwise of any intellectual property right. (c) Buyer Remedy. Omron's sole obligation hereunder shall be, at Omron's election, to (i) replace (in the form originally shipped with Buyer responsible for labor charges for removal or replacement thereof) the non-complying Product, (ii) repair the non-complying Product, or (iii) repay or credit Buyer an amount equal to the purchase price of the non-complying Product; provided that in no event shall Omron be responsible for warranty, repair, indemnity or any other claims or expenses regarding the Products unless Omron's analysis confirms that the Products were properly handled, stored, installed and maintained and not subject to contamination, abuse, misuse or inappropriate modification. Return of any Products by Buyer must be approved in writing by Omron before shipment. Omron Companies shall not be liable for the suitability or unsuitability or the results from the use of Products in combination with any electrical or electronic components, circuits, system assemblies or any other materials or substances or environments. Any advice, recommendations or information given orally or in writing, are not to be construed as an amendment or addition to the above warranty.

See <http://www.omron.com/global/> or contact your Omron representative for published information.

Limitation on Liability: Etc.

OMRON COMPANIES SHALL NOT BE LIABLE FOR SPECIAL, INDIRECT, INCIDENTAL, OR CONSEQUENTIAL DAMAGES, LOSS OF PROFITS OR PRODUCTION OR COMMERCIAL LOSS IN ANY WAY CONNECTED WITH THE PRODUCTS, WHETHER SUCH CLAIM IS BASED IN CONTRACT, WARRANTY, NEGLIGENCE OR STRICT LIABILITY.

Further, in no event shall liability of Omron Companies exceed the individual price of the Product on which liability is asserted.

Suitability of Use.

Omron Companies shall not be responsible for conformity with any standards, codes or regulations which apply to the combination of the Product in the Buyer's application or use of the Product. At Buyer's request, Omron will provide applicable third party certification documents identifying ratings and limitations of use which apply to the Product. This information by itself is not sufficient for a complete determination of the suitability of the Product in combination with the end product, machine, system, or other application or use. Buyer shall be solely responsible for determining appropriateness of the particular Product with respect to Buyer's application, product or system. Buyer shall take application responsibility in all cases.

NEVER USE THE PRODUCT FOR AN APPLICATION INVOLVING SERIOUS RISK TO LIFE OR PROPERTY OR IN LARGE QUANTITIES WITHOUT ENSURING THAT THE SYSTEM AS A WHOLE HAS BEEN DESIGNED TO ADDRESS THE RISKS, AND THAT THE OMRON PRODUCT(S) IS PROPERLY RATED AND INSTALLED FOR THE INTENDED USE WITHIN THE OVERALL EQUIPMENT OR SYSTEM.

Programmable Products.

Omron Companies shall not be responsible for the user's programming of a programmable Product, or any consequence thereof.

Performance Data.

Data presented in Omron Company websites, catalogs and other materials is provided as a guide for the user in determining suitability and does not constitute a warranty. It may represent the result of Omron's test conditions, and the user must correlate it to actual application requirements. Actual performance is subject to the Omron's Warranty and Limitations of Liability.

Change in Specifications.

Product specifications and accessories may be changed at any time based on improvements and other reasons. It is our practice to change part numbers when published ratings or features are changed, or when significant construction changes are made. However, some specifications of the Product may be changed without any notice. When in doubt, special part numbers may be assigned to fix or establish key specifications for your application. Please consult with your Omron's representative at any time to confirm actual specifications of purchased Product.

Errors and Omissions.

Information presented by Omron Companies has been checked and is believed to be accurate; however, no responsibility is assumed for clerical, typographical or proofreading errors or omissions.