

Sensor/actuator cable - SAC-8P-MR/ 1,5-542/ FS SCO BK - 1406095

Please be informed that the data shown in this PDF Document is generated from our Online Catalog. Please find the complete data in the user's documentation. Our General Terms of Use for Downloads are valid (<http://phoenixcontact.com/download>)



Sensor/actuator cable, 8-position, PVC, yellow, Plug angled M12 SPEEDCON, A-coded, on Socket straight M12 SPEEDCON, A-coded, cable length: 1.5 m



Key Commercial Data

| | |
|--------------------------------------|---|
| Packing unit | 1 pc |
| GTIN |  4 046356 799539 |
| GTIN | 4046356799539 |
| Weight per Piece (excluding packing) | 1.000 g |
| Custom tariff number | 85444290 |
| Country of origin | United States |

Technical data

Dimensions

| | |
|-----------------|-------|
| Length of cable | 1.5 m |
|-----------------|-------|

Ambient conditions

| | |
|---------------------------------|----------------------------------|
| Ambient temperature (operation) | -25 °C ... 90 °C (Plug / socket) |
| Degree of protection | IP65 |
| | IP67 |
| | IP68 |

General

| | |
|-----------------------|---------|
| Rated current at 40°C | 2 A |
| Rated voltage | 30 V AC |
| | 30 V DC |

Sensor/actuator cable - SAC-8P-MR/ 1,5-542/ FS SCO BK - 1406095

Technical data

General

| | |
|------------------------------|-------------------------------|
| Number of positions | 8 |
| Color handle area | black |
| Insulation resistance | ≥ 100 MΩ |
| Coding | A - standard |
| Standards/regulations | M12 connector IEC 61076-2-101 |
| Status display | No |
| Protective circuit/component | unwired |
| Overvoltage category | II |
| Degree of pollution | 3 |
| Insertion/withdrawal cycles | ≥ 100 |
| Torque | 0.4 Nm (M12 connector) |

Material

| | |
|--|---|
| Flammability rating according to UL 94 | HB |
| Contact material | CuZn |
| Contact surface material | Ni/Au |
| Contact carrier material | TPU GF |
| Material of grip body | TPU, hardly inflammable, self-extinguishing |
| Material, knurls | Zinc die-cast, nickel-plated |
| Sealing material | NBR |

Standards and Regulations

| | |
|--|-------------------------------|
| Standards/specifications | M12 connector IEC 61076-2-101 |
| Flammability rating according to UL 94 | HB |

Cable

| | |
|---|--|
| Cable type | PVC yellow 105 °C |
| Cable type (abbreviation) | 542 |
| UL AWM style | 2517 (105 °C / 300 V) |
| AWG signal line | 24 |
| Conductor structure signal line | 32x 1.10 mm |
| Core diameter including insulation | 1.12 mm ±0.03 mm |
| Wire colors | white, brown, green, yellow, gray, pink, blue, red |
| Overall twist | 8 wires around filler to the core |
| External sheath, color | yellow |
| External cable diameter D | 5.7 mm ±0.2 mm |
| Minimum bending radius, flexible installation | 8 x D |
| Cable weight | 44 kg/km |
| Outer sheath, material | PVC |

Sensor/actuator cable - SAC-8P-MR/ 1,5-542/ FS SCO BK - 1406095

Technical data

Cable

| | |
|---------------------------------|---|
| Material, filler | PP |
| Material conductor insulation | PVC |
| Conductor material | Tin-plated Cu litz wires |
| Insulation resistance | ≥ (550 M Ohms/m @ 500V) |
| Conductor resistance | max. 79.7 Ω/km (20 °C) |
| Nominal voltage, cable | 300 V |
| Flame resistance | FT1, VW-1 |
| Other resistance | UV resistant |
| Ambient temperature (operation) | -30 °C ... 105 °C (cable, fixed installation) |
| | -5 °C ... 105 °C (cable, flexible installation) |

Environmental Product Compliance

| | |
|------------|---|
| | Lead 7439-92-1 |
| China RoHS | Environmentally Friendly Use Period = 50 |
| | For details about hazardous substances go to tab "Downloads", Category "Manufacturer's declaration" |

Drawings

Sensor/actuator cable - SAC-8P-MR/ 1,5-542/ FS SCO BK - 1406095

Schematic diagram

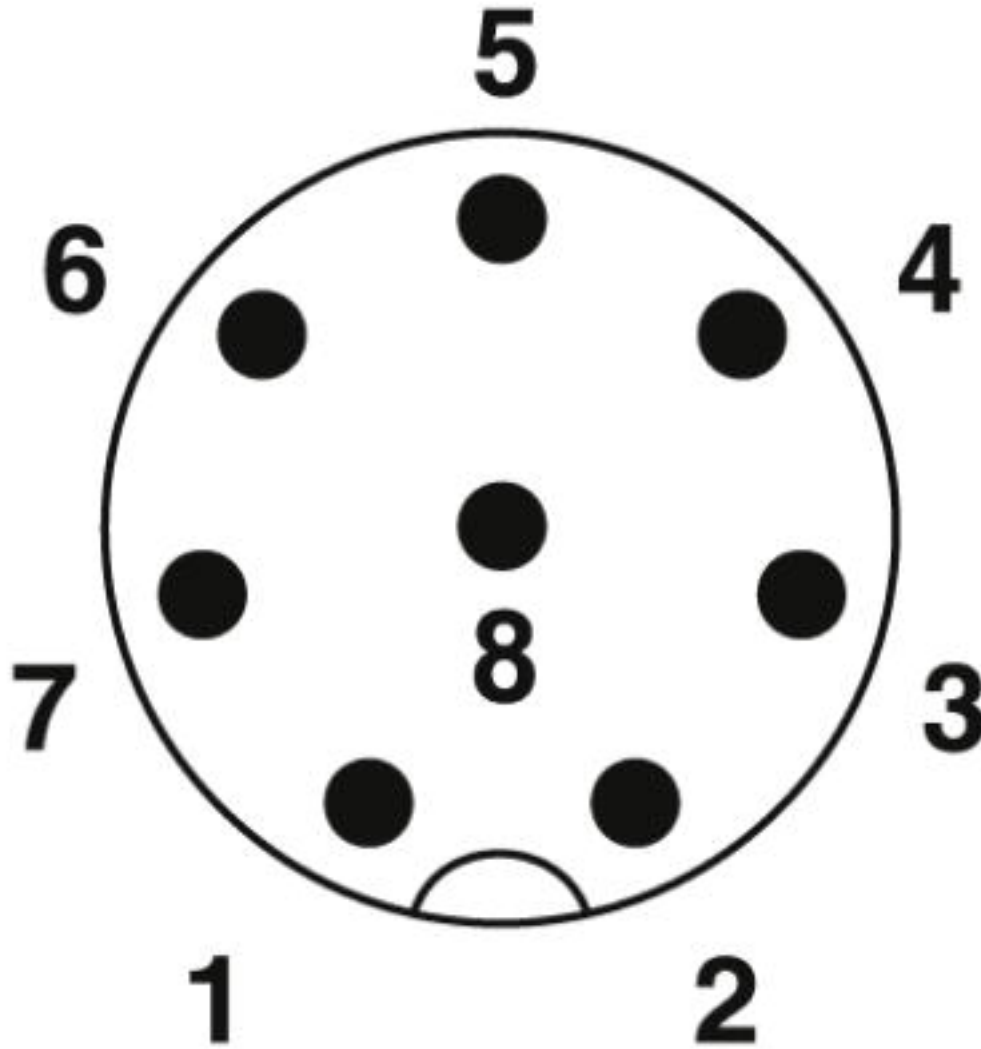

Pin assignment M12 plug, 8-pos., A-coded, view plug side

Sensor/actuator cable - SAC-8P-MR/ 1,5-542/ FS SCO BK - 1406095

Schematic diagram

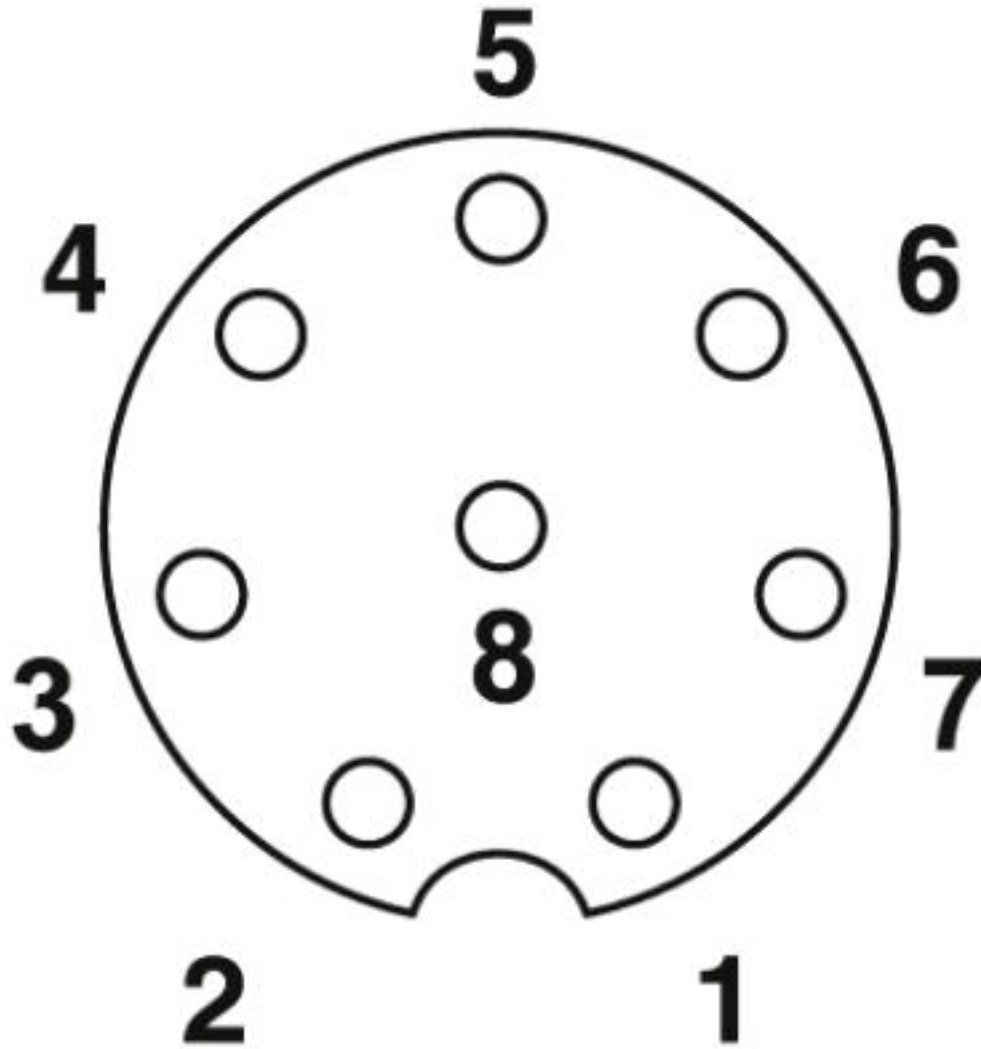

Pin assignment M12 socket, 8-pos., A-coded, view female side

Sensor/actuator cable - SAC-8P-MR/ 1,5-542/ FS SCO BK - 1406095

Dimensional drawing

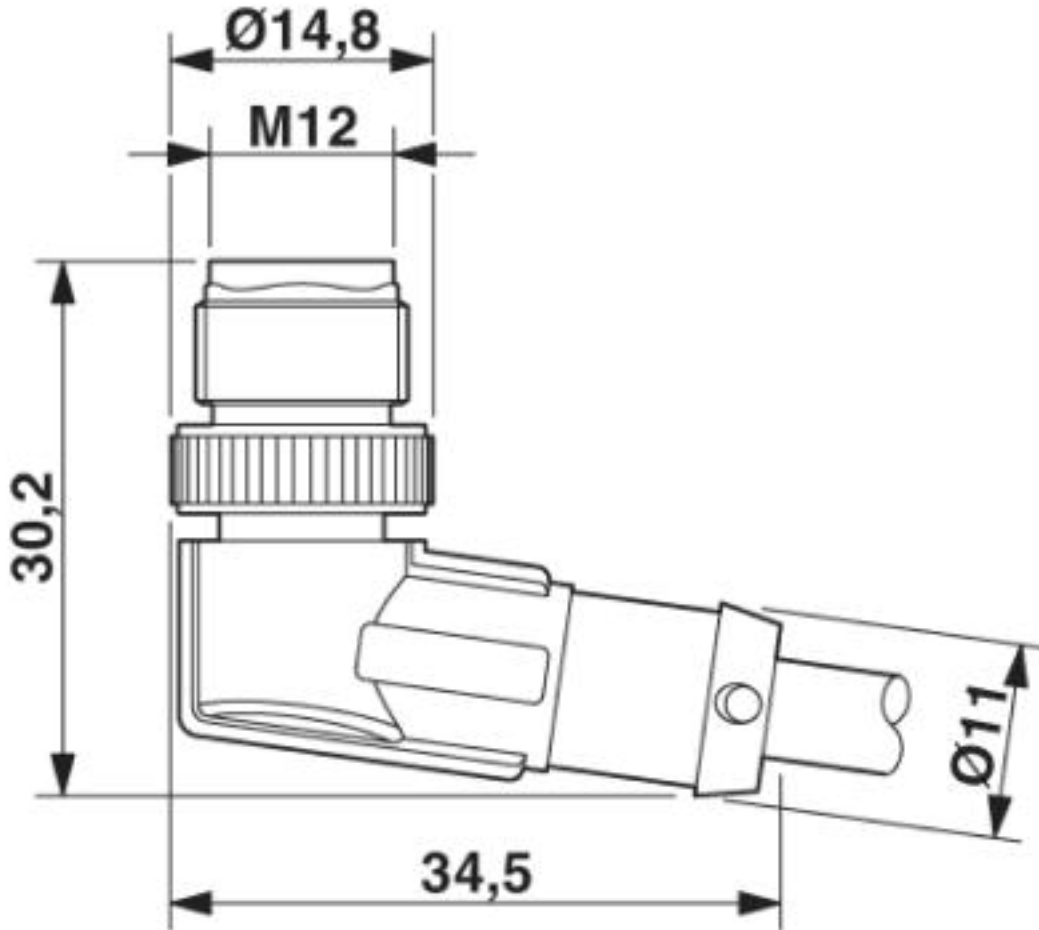

M12 x 1 male plug, angled

Sensor/actuator cable - SAC-8P-MR/ 1,5-542/ FS SCO BK - 1406095

Dimensional drawing

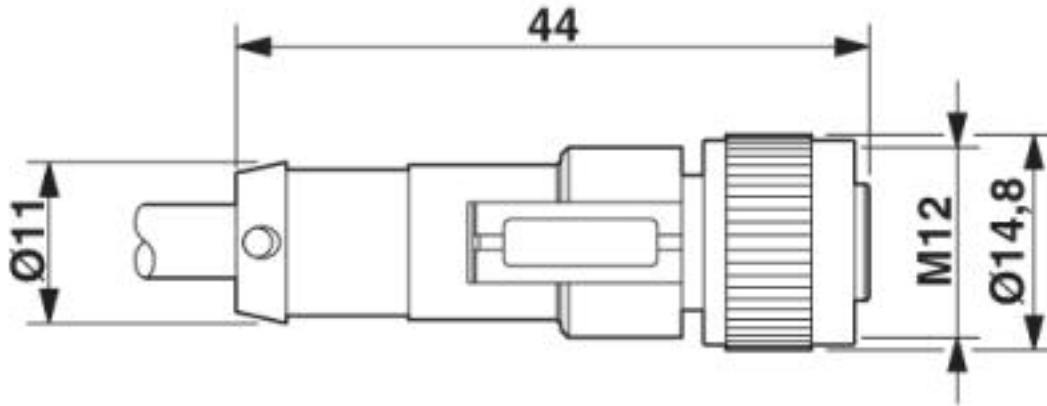

M12 x 1 socket, straight

Circuit diagram

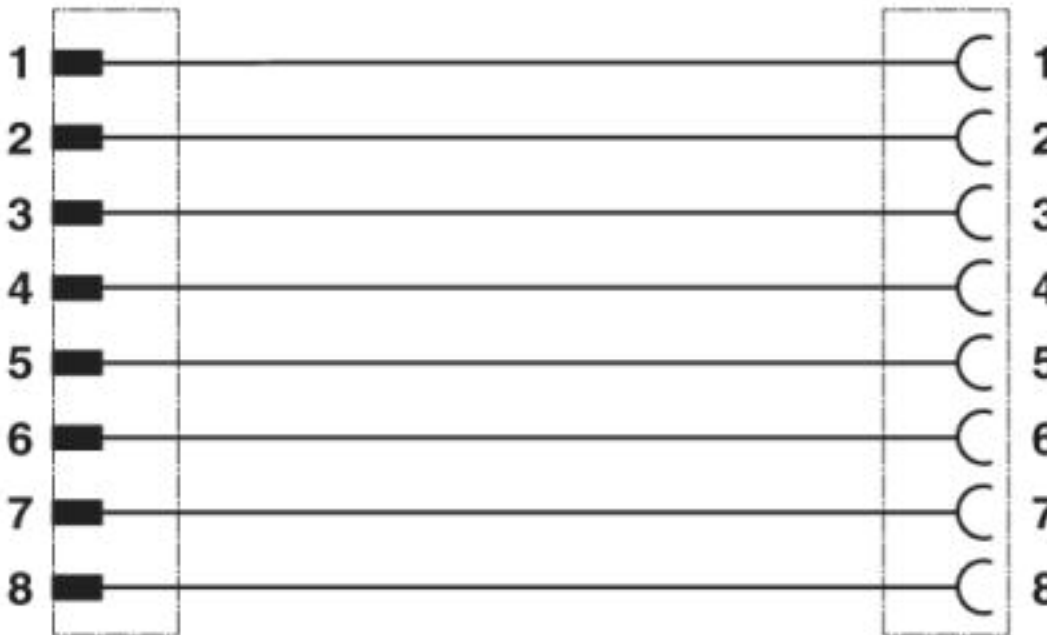

Contact assignment of the M12 plug and the M12 socket

Sensor/actuator cable - SAC-8P-MR/ 1,5-542/ FS SCO BK - 1406095

Cable cross section

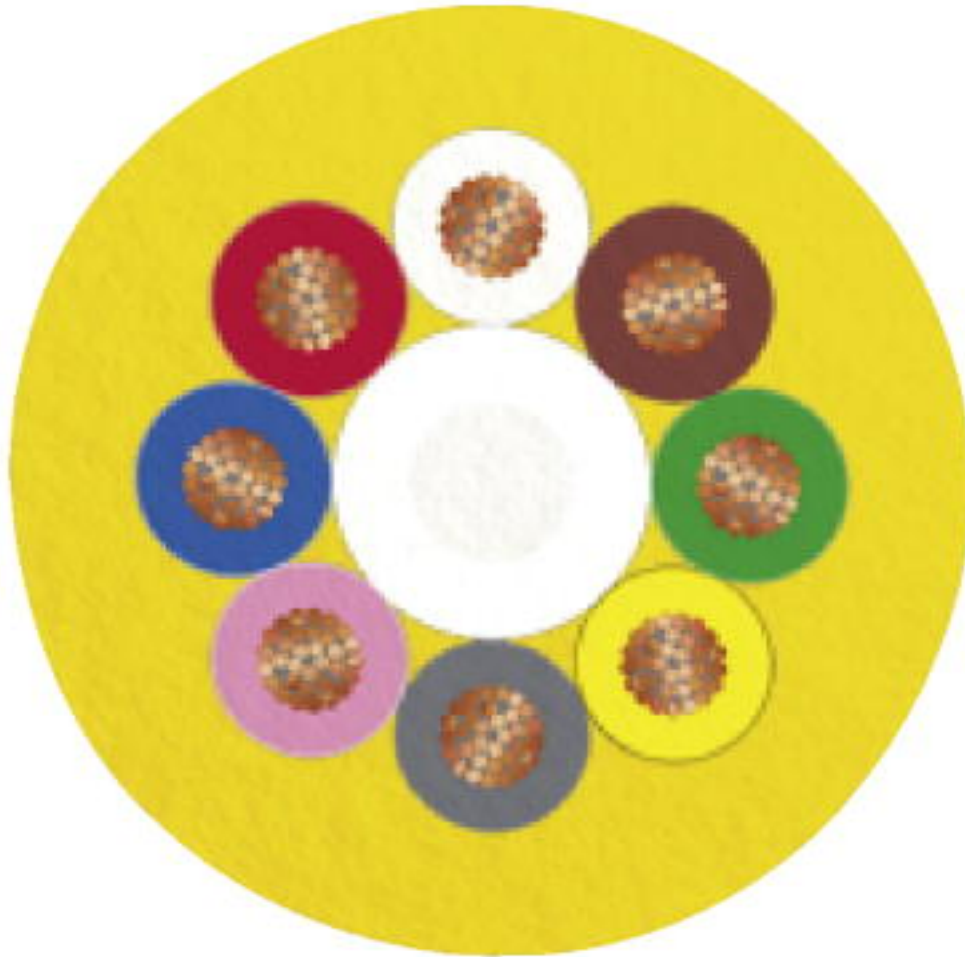

PVC yellow 105 °C [542]

Classifications

eCl@ss

| | |
|------------|----------|
| eCl@ss 4.0 | 27060300 |
| eCl@ss 4.1 | 27060300 |
| eCl@ss 5.0 | 27061800 |
| eCl@ss 5.1 | 27061800 |
| eCl@ss 6.0 | 27279200 |
| eCl@ss 7.0 | 27279218 |
| eCl@ss 8.0 | 27279218 |

Sensor/actuator cable - SAC-8P-MR/ 1,5-542/ FS SCO BK - 1406095

Classifications

eCl@ss

| | |
|------------|----------|
| eCl@ss 9.0 | 27060311 |
|------------|----------|

ETIM

| | |
|----------|----------|
| ETIM 3.0 | EC001855 |
| ETIM 4.0 | EC001855 |
| ETIM 5.0 | EC001855 |
| ETIM 6.0 | EC001855 |
| ETIM 7.0 | EC001855 |

UNSPSC

| | |
|---------------|----------|
| UNSPSC 6.01 | 31251501 |
| UNSPSC 7.0901 | 31251501 |
| UNSPSC 11 | 31251501 |
| UNSPSC 12.01 | 31251501 |
| UNSPSC 13.2 | 31251501 |
| UNSPSC 19.0 | 31251501 |
| UNSPSC 20.0 | 31251501 |
| UNSPSC 21.0 | 31251501 |

Approvals

Approvals

Approvals

UL Listed / cUL Listed / EAC / cULus Listed

Ex Approvals

Approval details

| | | | |
|--------------------|---|---|---------------|
| UL Listed |  | http://database.ul.com/cgi-bin/XYV/template/LISEXT/1FRAME/index.htm | FILE E 221474 |
| Nominal voltage UN | 30 V | | |
| Nominal current IN | 2 A | | |

Sensor/actuator cable - SAC-8P-MR/ 1,5-542/ FS SCO BK - 1406095

Approvals

| | | | |
|--------------------|--|---|---------------|
| cUL Listed | | http://database.ul.com/cgi-bin/XYVV/template/LISEXT/1FRAME/index.htm | FILE E 221474 |
| Nominal voltage UN | | 30 V | |
| Nominal current IN | | 2 A | |

| | | |
|-----|--|--------------------------|
| EAC | | RU C- DE.BL08.B.00286 |
|-----|--|--------------------------|

| | |
|--------------|--|
| cULus Listed | |
|--------------|--|

Accessories

Accessories

Conductor marking

Insert label - PABA WH/23 - 1013779



Insert label, Strip, white, unlabeled, can be labeled with: CMS-P1-PLOTTER, mounting type: thread on, cable diameter range: 1.5 ... 35 mm, lettering field size: 23 x 4 mm, Number of individual labels: 20

Insert label - PABA YE/23 - 1013782



Insert label, Strip, yellow, unlabeled, can be labeled with: CMS-P1-PLOTTER, mounting type: thread on, cable diameter range: 1.5 ... 35 mm, lettering field size: 23 x 4 mm, Number of individual labels: 20

Marker pen

Sensor/actuator cable - SAC-8P-MR/ 1,5-542/ FS SCO BK - 1406095

Accessories

Marker pen - B-STIFT - 1051993



Marker pen, for manual labeling of unprinted Zack strips, smear-proof and waterproof, line thickness 0.5 mm

Plug for cable screw gland

Screw plug - PROT-M12 MS-PA-CHAIN - 1430899

M12 sealing cap with fixing band, for sensor cables, for free M12 sockets



Protective cap

Sealing cap - PROT-M12 FS-PA-CHAIN - 1430873

M12 sealing cap made of plastic with fixing band, for sensor cables, for free M12 plugs



Safety locking

Locking clip - SAC-M12-EXCLIP-M - 1558988



Locking clip for the pin side of sensor/actuator cables with M12 connector and M12 connectors for assembly, for knurl diameter: 15 mm or for Allen key with a wrench size of 14 mm, prevents the disconnection of plug-in connections without tools

Sensor/actuator cable - SAC-8P-MR/ 1,5-542/ FS SCO BK - 1406095

Accessories

Locking clip - SAC-M12-EXCLIP-F - 1558991



Locking clip for the socket side of sensor/actuator cables with M12 connector and M12 connectors for assembly, for knurl diameter: 15 mm or for Allen key with a wrench size of 14 mm, prevents the disconnection of plug-in connections without tools

Screwdriver tools

Adapter insert - TSD-M SAC-BIT ADAPTER - 1212600



Adapter bit for TSD-M...torque tools, E6.3-1/4" drive with 4 mm hexagon to accommodate SAC bits

Tool - SAC BIT M12-D15 - 1208432



Nut for assembling sensor/actuator cables with M12 connector and M12 connectors for assembly, with a knurl diameter of 15 mm, for 4 mm hexagonal drive

Torque tool

Torque screwdriver - TSD 04 SAC - 1208429



Torque screwdriver, with preset torque of 0.4 Nm and 4 mm hexagonal drive for M12 connectors

Torque screwdriver - TSD-M 1,2NM - 1212224



Torque screw driver, accuracy as per EN ISO 6789 standard, adjustable from 0.3 - 1.2 Nm

Sensor/actuator cable - SAC-8P-MR/ 1,5-542/ FS SCO BK - 1406095

Accessories

Phoenix Contact 2020 © - all rights reserved
<http://www.phoenixcontact.com>