

## Contact insert - HC-BB 18-ESTC - 1687464

Please be informed that the data shown in this PDF Document is generated from our Online Catalog. Please find the complete data in the user's documentation. Our General Terms of Use for Downloads are valid (<http://phoenixcontact.com/download>)

HEAVYCON male insert, BB18 series, 18-pos., crimp connection



### Key Commercial Data

Packing unit	1 pc
Weight per Piece (excluding packing)	50.8 g
Custom tariff number	85366990
Country of origin	Romania

### Technical data

#### General

Note	For HC-B10 housing, crimp contacts CK 2,5-ED (crimp contacts not included in scope of supply)
Connection method	Crimp connection
Degree of pollution	3
Overvoltage category	III
Number of positions	18+PE
Insertion/withdrawal cycles	≥ 500
Size	B10
Connection in acc. with standard	IEC / EN
Conductor cross section	0.5 mm <sup>2</sup> ... 4 mm <sup>2</sup>
Connection cross section AWG	20 ... 12
Stripping length of the individual wire	7.5 mm
Assembly instructions	- Housing heights of $h \geq 72$ mm are recommended when there is a high number of wires.
Connection	Connectors may be plugged in only when there is no load/voltage.

#### Ambient conditions

# Contact insert - HC-BB 18-ESTC - 1687464

## Technical data

### Ambient conditions

Ambient temperature (operation)	-40 °C ... 125 °C (including heating up of contacts)
---------------------------------	--

### Material data

Flammability rating according to UL 94	V0
Contact material	Copper alloy
Contact surface material	Ag (alternatively Au)
Contact carrier material	PC

### Electrical characteristics

Rated voltage (III/3)	500 V
Rated surge voltage	6 kV
Rated current	16 A

### Standards and Regulations

Connection in acc. with standard	IEC / EN
	CSA
Flammability rating according to UL 94	V0

## Classifications

### eCl@ss

eCl@ss 4.0	27140816
eCl@ss 4.1	27140816
eCl@ss 5.0	27143424
eCl@ss 5.1	27143424
eCl@ss 6.0	27261205
eCl@ss 7.0	27440207
eCl@ss 8.0	27440205
eCl@ss 9.0	27440205

### ETIM

ETIM 2.0	EC000438
ETIM 3.0	EC000438
ETIM 4.0	EC000438
ETIM 5.0	EC000438

### UNSPSC

UNSPSC 6.01	30211923
UNSPSC 7.0901	39121522

# Contact insert - HC-BB 18-ESTC - 1687464

## Classifications

### UNSPSC

UNSPSC 11	39121522
UNSPSC 12.01	39121522
UNSPSC 13.2	39121522

## Approvals

### Approvals

Approvals

CSA / UL Recognized / EAC / EAC

Ex Approvals

Approvals submitted

### Approval details

CSA 	
mm <sup>2</sup> /AWG/kcmil	20-12
Nominal current I <sub>N</sub>	16 A
Nominal voltage U <sub>N</sub>	600 V

UL Recognized 
---

EAC
-----

EAC
-----

## Drawings

# Contact insert - HC-BB 18-ESTC - 1687464

Diagram

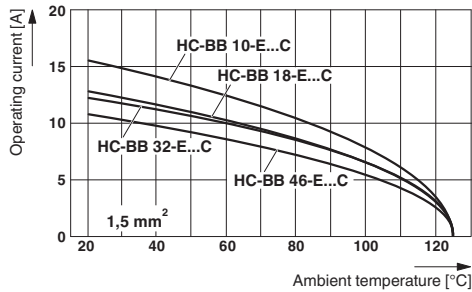

Derating diagram: Conductor cross section 1.5 mm<sup>2</sup>

Diagram

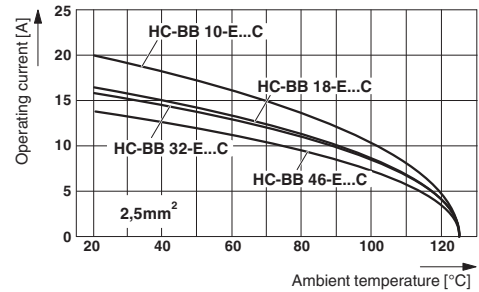

Derating diagram: Conductor cross section 2.5 mm<sup>2</sup>

Dimensional drawing

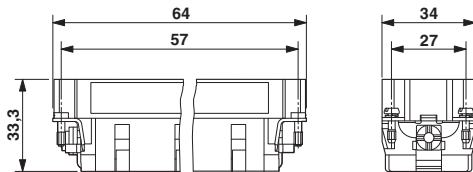

Male insert

Schematic diagram

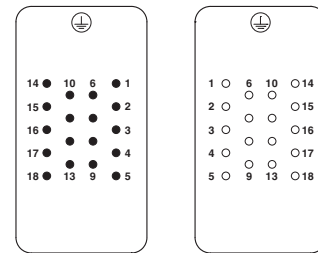

Connector pin assignment: Left pin - right socket

Dimensional drawing

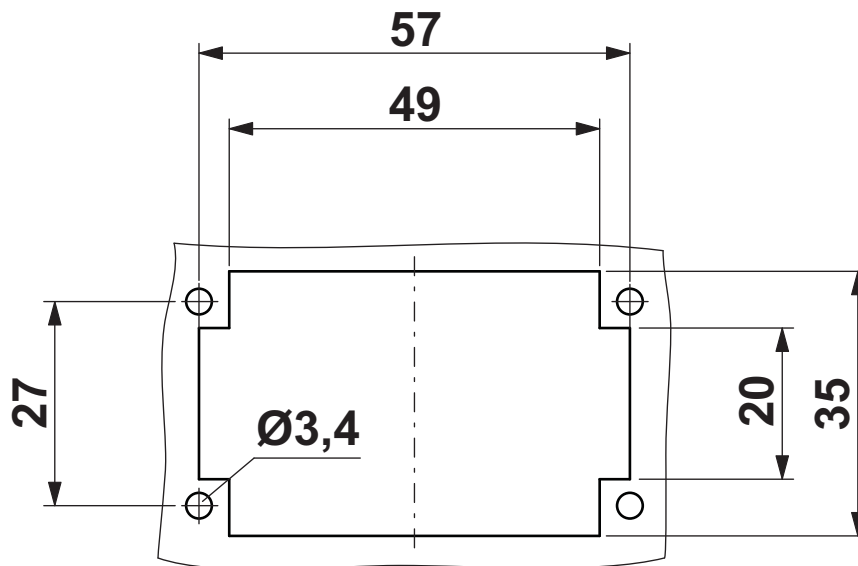

Panel cutout

