

Single relay - REL-IR4/LDP- 48DC/4X21 - 2903678

Please be informed that the data shown in this PDF Document is generated from our Online Catalog. Please find the complete data in the user's documentation. Our General Terms of Use for Downloads are valid (<http://phoenixcontact.com/download>)



Plug-in industrial relay with power contacts, 4 PDTs, test key, status LED, freewheeling diode, mechanical switch position indicator, polarity: A1+, A2-, coil voltage: 48 V DC



COMPLETE™

Key Commercial Data

Packing unit	1 pc
Minimum order quantity	10 pc
GTIN	 4 046356 758918
GTIN	4046356758918
Weight per Piece (excluding packing)	34.000 g
Custom tariff number	85364190
Country of origin	Poland

Technical data

Dimensions

Width	21.2 mm
Height	27.5 mm
Depth	35.6 mm

Ambient conditions

Ambient temperature (operation)	-40 °C ... 70 °C
Ambient temperature (storage/transport)	-40 °C ... 85 °C
Degree of protection	RT I

Coil side

Nominal input voltage U_N	48 V DC
-----------------------------	---------

Single relay - REL-IR4/LDP- 48DC/4X21 - 2903678

Technical data

Coil side

Input voltage range in reference to U_N	see diagram
Typical input current at U_N	22 mA
Typical response time	13 ms
Typical release time	14 ms
Protective circuit	Damping diode
Status display	Yellow LED
Power dissipation for nominal condition	1.06 W

Contact side

Contact type	4 PDTs
Type of switch contact	Single contact
Contact material	AgNi
Maximum switching voltage	250 V AC/DC
Minimum switching voltage	5 V (At 24 mA)
Min. switching current	5 mA (at 24 V)
Maximum inrush current	16 A (20 ms, N/O contact)
Limiting continuous current	6 A
Interrupting rating (ohmic load) max.	144 W (at 24 V DC)
	124 W (at 48 V DC)
	108 W (at 60 V DC)
	52 W (at 110 V DC)
	48 W (at 220 V DC)
	1500 VA (for 250 V AC)
Switching capacity min.	0.12 W
Switching capacity	2 A (at 24 V, DC13)
	0.22 A (at 120 V, DC13)
	0.11 A (at 250 V, DC13)
	1.5 A (at 24 V, AC15)
	1.5 A (at 120 V, AC15)
	1 A (at 240 V, AC15)
Motor load according to UL 508	1/3 HP, 240 V AC

General

Test voltage relay winding/relay contact	2.5 kV _{rms} (50 Hz, 1 min.)
Test voltage PDT/PDT	2 kV _{rms} (50 Hz, 1 min.)
Operating mode	100% operating factor
Mechanical service life	approx. 2×10^7 cycles
Service life, electrical	see diagram

Single relay - REL-IR4/LDP- 48DC/4X21 - 2903678

Technical data

General

Mounting position	any
-------------------	-----

Connection data

Connection method	Plug connection
-------------------	-----------------

Standards and Regulations

Connection in acc. with standard	CSA
Standards/regulations	IEC 60664
	IEC 61810
Rated insulation voltage	250 V AC
Rated surge voltage	2.5 kV
Insulation	Basic insulation
Pollution degree	2
Overvoltage category	II

Environmental Product Compliance

China RoHS	Environmentally Friendly Use Period = 50
	For details about hazardous substances go to tab "Downloads", Category "Manufacturer's declaration"

Drawings

Single relay - REL-IR4/LDP- 48DC/4X21 - 2903678

Diagram

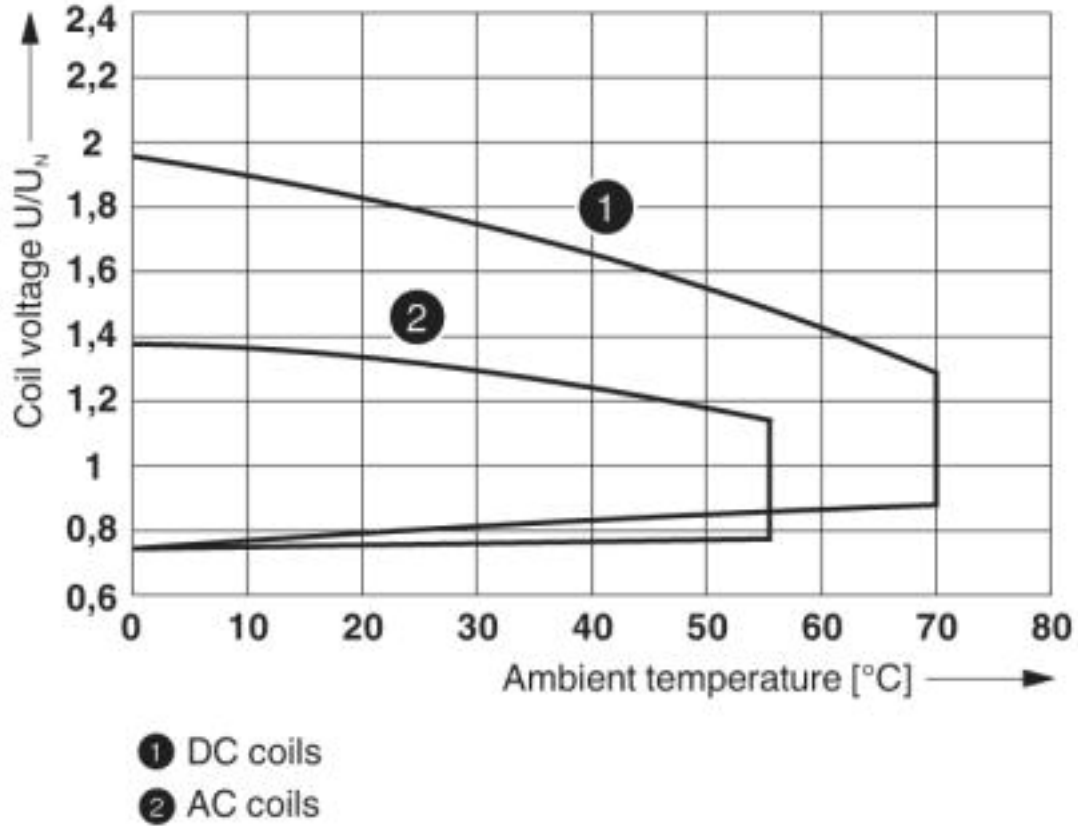

Operating voltage range

Single relay - REL-IR4/LDP- 48DC/4X21 - 2903678

Diagram

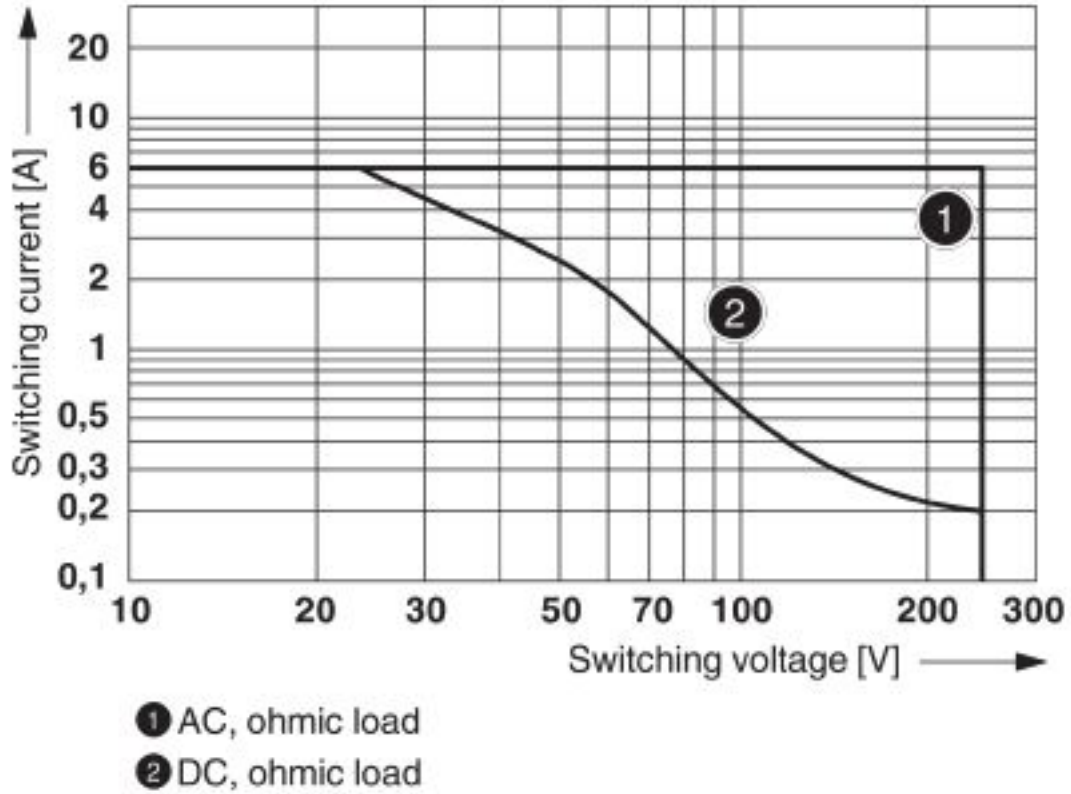

Interrupting rating

Single relay - REL-IR4/LDP- 48DC/4X21 - 2903678

Diagram

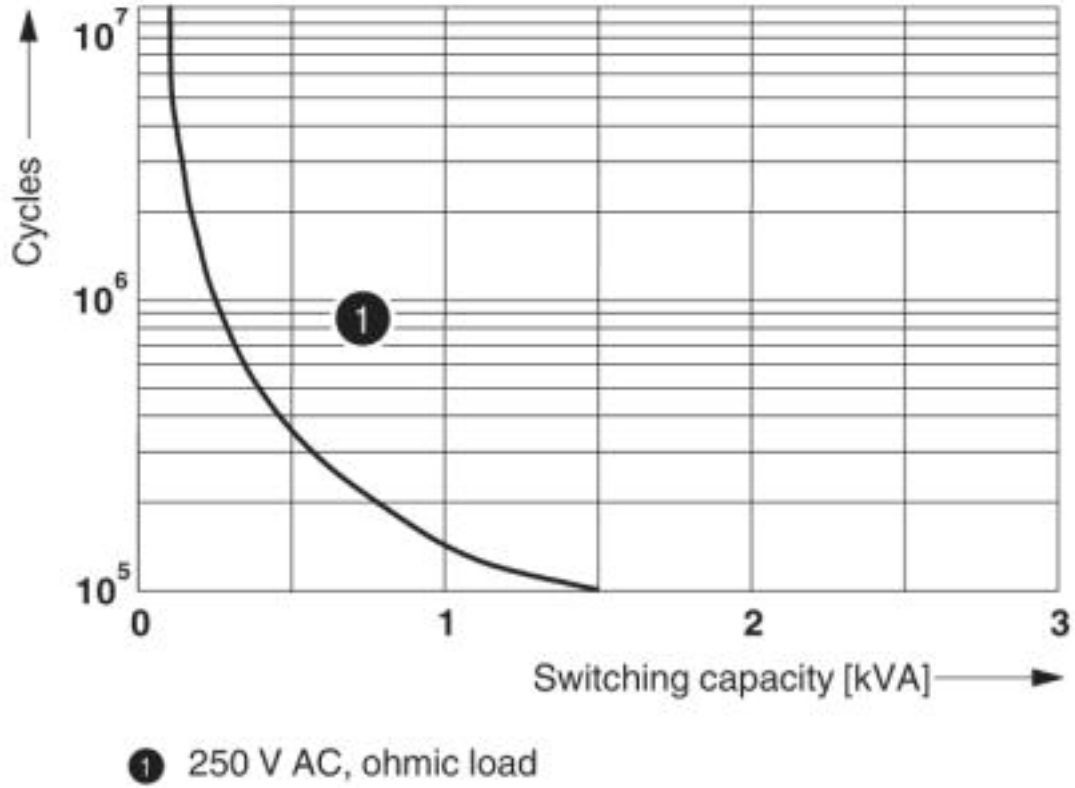

Electrical service life

Single relay - REL-IR4/LDP- 48DC/4X21 - 2903678

Diagram

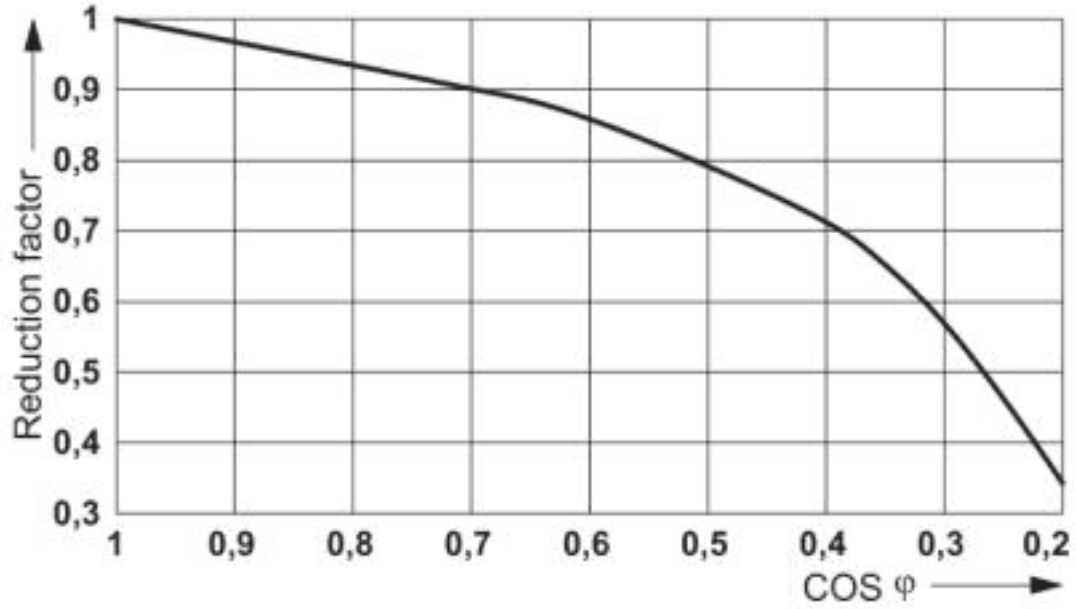

Service life reduction factor

Single relay - REL-IR4/LDP- 48DC/4X21 - 2903678

Circuit diagram

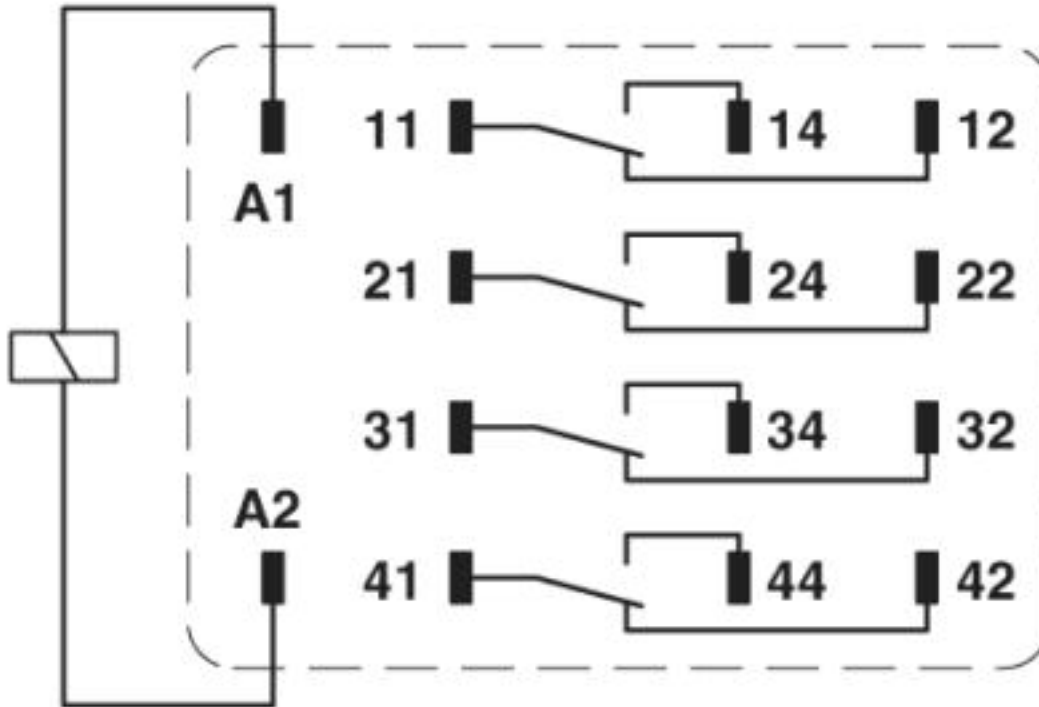

Classifications

eCl@ss

eCl@ss 4.0	27371100
eCl@ss 4.1	27371100
eCl@ss 5.0	27371600
eCl@ss 5.1	27371600
eCl@ss 6.0	27371600
eCl@ss 7.0	27371601
eCl@ss 8.0	27371601
eCl@ss 9.0	27371601

ETIM

ETIM 2.0	EC001437
ETIM 3.0	EC001437
ETIM 4.0	EC001437
ETIM 5.0	EC001437
ETIM 6.0	EC001437
ETIM 7.0	EC001437

Single relay - REL-IR4/LDP- 48DC/4X21 - 2903678

Classifications

UNSPSC

UNSPSC 6.01	30211916
UNSPSC 7.0901	39121515
UNSPSC 11	39121515
UNSPSC 12.01	39121515
UNSPSC 13.2	39122334

Approvals

Approvals

Approvals

CSA / UL Recognized / cUL Recognized / VDE Zeichengenehmigung / EAC / cULus Recognized

Ex Approvals

Approval details

CSA		http://www.csagroup.org/services-industries/product-listing/	2554095
-----	---	---	---------

UL Recognized		http://database.ul.com/cgi-bin/XYV/template/LISEXT/1FRAME/index.htm	FILE E 172140
---------------	---	---	---------------

cUL Recognized		http://database.ul.com/cgi-bin/XYV/template/LISEXT/1FRAME/index.htm	FILE E 172140
----------------	---	---	---------------

VDE Zeichengenehmigung		http://www2.vde.com/de/Institut/Online-Service/VDE-gepruefteProdukte/Seiten/Online-Suche.aspx	40040427
------------------------	---	---	----------

EAC			TR_TS_D_00573_c
-----	---	--	-----------------

Single relay - REL-IR4/LDP- 48DC/4X21 - 2903678

Approvals

cULus Recognized



Accessories

Accessories

Relay socket

Relay base - RIF-2-BPT/4X21 - 2900934



RIF-2... relay base, for industrial relay with 2 or 4 PDTs, push-in connection, plug-in option for input/suppressor modules, for mounting on NS 35/7,5