

Data sheet | Item number: 857-358

Relay module; Nominal input voltage: 230 V AC/DC; 1 changeover contact;
Limiting continuous current: 6 A; Yellow status indicator; Module width: 6
mm; 2,50 mm²; gray

www.wago.com/857-358

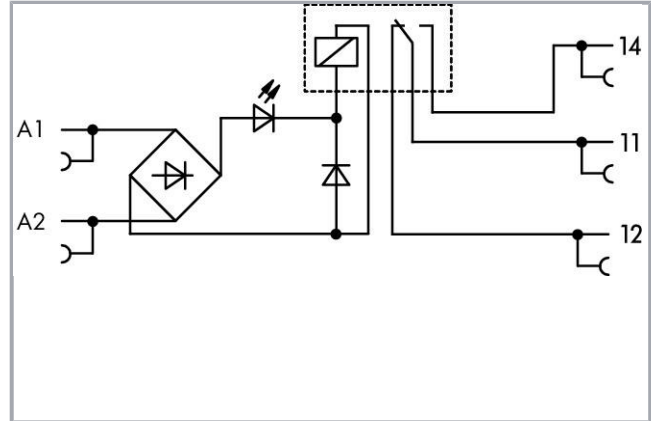

RoHS Compliant

[BOMcheck.net](https://www.bomcheck.net)

Color:

Subject to changes. Please also observe the further product documentation!

WAGO Kontakttechnik GmbH & Co. KG
Hansastr. 27
32423 Minden
Phone: +49571 887-0 | Fax: +49571 887-169
Email: info.de@wago.com | Web: www.wago.com

Do you have any questions about our products?
We are always happy to take your call at +49 (571) 887-44222.

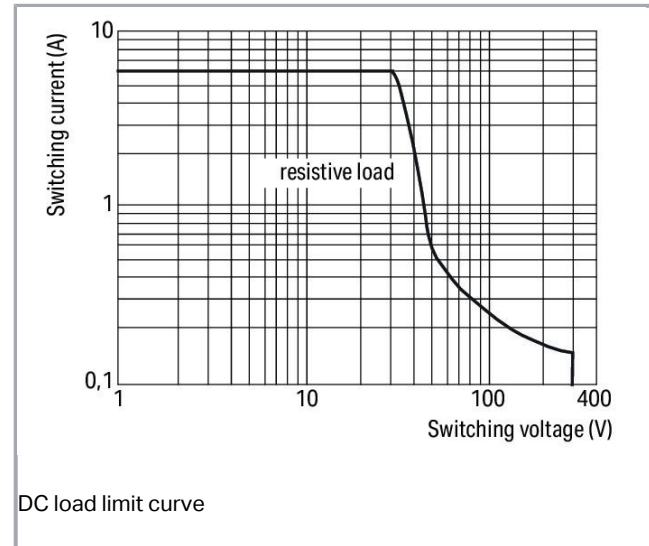
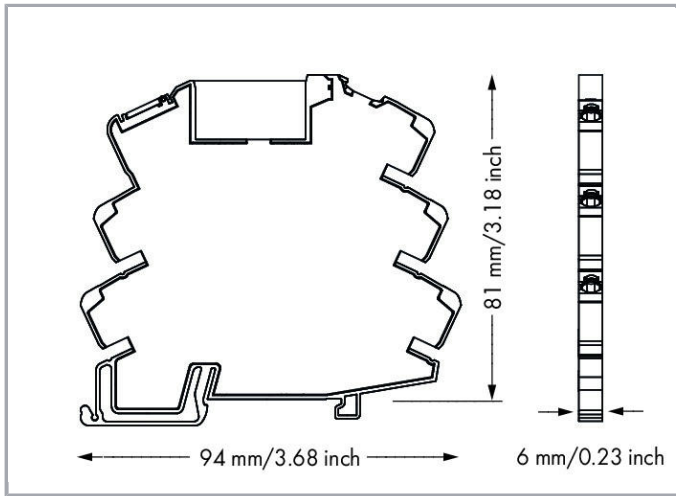

Item description

Note:

To protect the relay coils and contacts, inductive loads must be dampened with an effective protection circuit.

Data

Technical Data

Control circuit

Nominal input voltage U_N	AC/DC 230 V
Input voltage range	-20 ... +10 %
Nominal input current at U_N	3,5 mA

Load circuit:

Number of changeover/switchover contacts	1
Contact material (relay)	AgSnO ₂
Limiting continuous current	6 A
Inrush current (resistive) (max.)	(AC) 20 A / 0,02 s
Switching voltage (max.)	AC 250 V
Switching power (resistive) (max.)	AC 1500 VA; DC (see load limit curve)
Switching capacity	AC-15: 3 A / AC 250 V; DC-13: 2 A / DC 24 V

Subject to changes. Please also observe the further product documentation!



Recommended minimum load	10 V / 10 mA; 24 V / 1 mA
Pull-in time (typ.)	15 ms
Drop-out time (typ.)	25 ms
Bounce time (typ.)	3.5 ms
Electrical life (NO; resistive load; 23 °C)	50 x 10 ³ switching operations
Mechanical life	5 x 10 ⁶ switching operations
Switching frequency with/without load (max.)	6 min ⁻¹ / 180 min ⁻¹

Signaling

Status indicator	Yellow LED
------------------	------------

Safety and protection:

Rated voltage	250 V
Rated surge voltage	4 kV
Pollution degree	2
Dielectric strength, control/load circuit (AC, 1 min)	4 kVrms
Dielectric strength, open contact (AC, 1 min)	1 kVrms
Protection type	IP20

Connection data

Connection technology	Push-in CAGE CLAMP®
Solid conductor	0,34 ... 2,5 mm ² / 22 ... 14 AWG
Fine-stranded conductor	0,34 ... 2,5 mm ² / 22 ... 14 AWG
Strip length	9 ... 10 mm / 0.35 ... 0.39 inch

Geometrical Data

Width	6 mm / 0.236 inch
Height from upper-edge of DIN-rail	81 mm / 3.189 inch
Depth	94 mm / 3.701 inch

Mechanical data

Mounting type	DIN-35 rail
---------------	-------------

Material Data

Color	gray
-------	------

Subject to changes. Please also observe the further product documentation!

Fire load	0.651 MJ
Weight	32 g

Environmental Requirements

Surrounding air temperature (operation at U_N)	-40 ... 60 °C
Surrounding air temperature (storage)	-40 ... 70 °C
Processing temperature	-25 ... +50 °C

Standards and specifications

Standards/specifications	EN 61010-2-201; EN 61810-1; EN 61373; UL 508; GL; ATEX; IEC Ex
--------------------------	--

Elementary relay



WAGO Basic Relay	857-155
------------------	---------

Commercial data

Product Group	6 (Interface Electronics)
Packaging type	BOX
Country of origin	CN
GTIN	4045454471576
Customs tariff number	85364900990

Approvals / Certificates

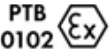
Ex-Approvals





Logo	Approval	Additional Approval Text	Certificate name
	ATEX DEKRA EXAM GmbH	EN 60079-0	BVS_14_ATEX_E_091_X
	IECEX DEKRA EXAM GmbH	IEC 60079-0	IECEX_BVS_14.0079_X
	UL UL International Germany GmbH (HAZARDOUS LOCATIONS)	ANSI/ISA 12.12.01	E198726 Sec.4

Ship Approvals

Subject to changes. Please also observe the further product documentation!

WAGO Kontakttechnik GmbH & Co. KG
Hansastr. 27
32423 Minden
Phone: +49571 887-0 | Fax: +49571 887-169
Email: info.de@wago.com | Web: www.wago.com

Do you have any questions about our products?
We are always happy to take your call at +49 (571) 887-44222.

Logo	Approval	Additional Approval Text	Certificate name
	BV Bureau Veritas S.A.	-	40179_A0
	DNV GL Det Norske Veritas, Germanischer Lloyd	-	TAA00001D1
	NK Nippon Kaiji Kyokai	-	TA17255M
	PRS Polski Rejestr Statków	-	TE/2186 /880590/18



UL-Approvals

Logo	Approval	Additional Approval Text	Certificate name
	UL UL International Netherlands B.V. (ORDINARY LOCATIONS)	UL 508	E175199 Sec.4

Counterpart

Compatible products

General accessories

	Item no.: 209-184 Protection cover; transparent	www.wago.com/209-184
	Item no.: 857-155 Basic relay; Nominal input voltage: 60 VDC; 1 changeover contact; Limiting continuous current: 6 A; Module width: 5 mm; Module height: 15 mm	www.wago.com/857-155

tools

Subject to changes. Please also observe the further product documentation!



Item no.: 210-720

Operating tool; Blade: 3.5 x 0.5 mm; with a partially insulated shaft

www.wago.com/210-720

ferrule



Item no.: 216-241

Ferrule; Sleeve for 0.5 mm² / 20 AWG; insulated; electro-tin plated; electrolytic copper; gastight crimped; acc. to DIN 46228, Part 4/09.90; white

www.wago.com/216-241



Item no.: 216-242

Ferrule; Sleeve for 0.75 mm² / 18 AWG; insulated; electro-tin plated; electrolytic copper; gastight crimped; acc. to DIN 46228, Part 4/09.90; gray

www.wago.com/216-242



Item no.: 216-243

Ferrule; Sleeve for 1 mm² / AWG 18; insulated; electro-tin plated; electrolytic copper; gastight crimped; acc. to DIN 46228, Part 4/09.90; red

www.wago.com/216-243



Item no.: 216-244

Ferrule; Sleeve for 1.5 mm² / AWG 16; insulated; electro-tin plated; electrolytic copper; gastight crimped; acc. to DIN 46228, Part 4/09.90; black

www.wago.com/216-244

Jumper



Item no.: 281-482

Jumper; insulated; gray

www.wago.com/281-482



Item no.: 859-402

Jumper; for jumper slot; 2-way; insulated; light gray

www.wago.com/859-402



Item no.: 859-402/000-005

Jumper; for jumper slot; 2-way; insulated; red

www.wago.com/859-402/000-005



Item no.: 859-402/000-006

Jumper; for jumper slot; 2-way; insulated; blue

www.wago.com/859-402/000-006



Item no.: 859-402/000-029

Jumper; for jumper slot; 2-way; insulated; yellow

www.wago.com/859-402/000-029



Item no.: 859-403

Jumper; for jumper slot; 3-way; insulated; light gray

www.wago.com/859-403



Item no.: 859-403/000-005

Jumper; for jumper slot; 3-way; insulated; red

www.wago.com/859-403/000-005



Item no.: 859-403/000-006

Jumper; for jumper slot; 3-way; insulated; blue

www.wago.com/859-403/000-006



Item no.: 859-403/000-029

Jumper; for jumper slot; 3-way; insulated; yellow

www.wago.com/859-403/000-029

Subject to changes. Please also observe the further product documentation!

WAGO Kontakttechnik GmbH & Co. KG

Hansastr. 27





32423 Minden

Phone: +49571 887-0 | Fax: +49571 887-169

Email: info.de@wago.com | Web: www.wago.com

Do you have any questions about our products?

We are always happy to take your call at +49 (571) 887-44222.

	Item no.: 859-404 Jumper; for jumper slot; 4-way; insulated; light gray	www.wago.com/859-404
	Item no.: 859-404/000-005 Jumper; for jumper slot; 4-way; insulated; red	www.wago.com/859-404/000-005
	Item no.: 859-404/000-006 Jumper; for jumper slot; 4-way; insulated; blue	www.wago.com/859-404/000-006
	Item no.: 859-404/000-029 Jumper; for jumper slot; 4-way; insulated; yellow	www.wago.com/859-404/000-029
	Item no.: 859-405 Jumper; for jumper slot; 5-way; insulated; light gray	www.wago.com/859-405
	Item no.: 859-405/000-005 Jumper; for jumper slot; 5-way; insulated; red	www.wago.com/859-405/000-005
	Item no.: 859-405/000-006 Jumper; for jumper slot; 5-way; insulated; blue	www.wago.com/859-405/000-006
	Item no.: 859-405/000-029 Jumper; for jumper slot; 5-way; insulated; yellow	www.wago.com/859-405/000-029
	Item no.: 859-406 Jumper; for jumper slot; 6-way; insulated; light gray	www.wago.com/859-406
	Item no.: 859-406/000-005 Jumper; for jumper slot; 6-way; insulated; red	www.wago.com/859-406/000-005
	Item no.: 859-406/000-006 Jumper; for jumper slot; 6-way; insulated; blue	www.wago.com/859-406/000-006
	Item no.: 859-406/000-029 Jumper; for jumper slot; 6-way; insulated; signal yellow	www.wago.com/859-406/000-029
	Item no.: 859-407 Jumper; for jumper slot; 7-way; insulated; light gray	www.wago.com/859-407
	Item no.: 859-407/000-005 Jumper; for jumper slot; 7-way; insulated; red	www.wago.com/859-407/000-005

Subject to changes. Please also observe the further product documentation!



Item no.: 859-407/000-006
Jumper; for jumper slot; 7-way; insulated; blue

www.wago.com/859-407/000-006



Item no.: 859-407/000-029
Jumper; for jumper slot; 7-way; insulated; yellow

www.wago.com/859-407/000-029



Item no.: 859-408
Jumper; for jumper slot; 8-way; insulated; light gray

www.wago.com/859-408



Item no.: 859-408/000-005
Jumper; for jumper slot; 8-way; insulated; red

www.wago.com/859-408/000-005



Item no.: 859-408/000-006
Jumper; for jumper slot; 8-way; insulated; blue

www.wago.com/859-408/000-006



Item no.: 859-408/000-029
Jumper; for jumper slot; 8-way; insulated; yellow

www.wago.com/859-408/000-029



Item no.: 859-409
Jumper; for jumper slot; 9-way; insulated; light gray

www.wago.com/859-409



Item no.: 859-409/000-005
Jumper; for jumper slot; 9-way; insulated; red

www.wago.com/859-409/000-005



Item no.: 859-409/000-006
Jumper; for jumper slot; 9-way; insulated; blue

www.wago.com/859-409/000-006



Item no.: 859-409/000-029
Jumper; for jumper slot; 9-way; insulated; yellow

www.wago.com/859-409/000-029



Item no.: 859-410
Jumper; for jumper slot; 10-way; insulated; light gray

www.wago.com/859-410



Item no.: 859-410/000-005
Jumper; for jumper slot; 10-way; insulated; red

www.wago.com/859-410/000-005

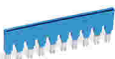

Item no.: 859-410/000-006
Jumper; for jumper slot; 10-way; insulated; blue

www.wago.com/859-410/000-006

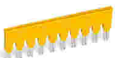















Item no.: 859-410/000-029
Jumper; for jumper slot; 10-way; insulated; yellow

www.wago.com/859-410/000-029

Marking accessories

Subject to changes. Please also observe the further product documentation!

	Item no.: 2009-110 Marking strips; on reel; not stretchable; plain; snap-on type; white	www.wago.com/2009-110
	Item no.: 2009-115 WMB-Inline; for Smart Printer; 1500 pieces on roll; stretchable 5 - 5.2 mm; plain; snap-on type; white	www.wago.com/2009-115
	Item no.: 2009-115/000-002 WMB-Inline; for Smart Printer; 1500 pieces on roll; stretchable 5 - 5.2 mm; plain; snap-on type; yellow	www.wago.com/2009-115/000-002
	Item no.: 2009-115/000-006 WMB-Inline; for Smart Printer; 1500 pieces on roll; stretchable 5 - 5.2 mm; plain; snap-on type; blue	www.wago.com/2009-115/000-006
	Item no.: 2009-115/000-007 WMB-Inline; for Smart Printer; 1500 pieces on roll; stretchable 5 - 5.2 mm; plain; snap-on type; gray	www.wago.com/2009-115/000-007
	Item no.: 2009-115/000-012 WMB-Inline; for Smart Printer; 1500 pieces on roll; stretchable 5 - 5.2 mm; plain; snap-on type; orange	www.wago.com/2009-115/000-012
	Item no.: 2009-115/000-017 WMB-Inline; for Smart Printer; 1500 pieces on roll; stretchable 5 - 5.2 mm; plain; snap-on type; light green	www.wago.com/2009-115/000-017
	Item no.: 2009-115/000-023 WMB-Inline; for Smart Printer; 1500 pieces on roll; stretchable 5 - 5.2 mm; plain; snap-on type; green	www.wago.com/2009-115/000-023
	Item no.: 2009-115/000-024 WMB-Inline; for Smart Printer; 1500 pieces on roll; stretchable 5 - 5.2 mm; plain; snap-on type; violet	www.wago.com/2009-115/000-024
	Item no.: 209-128 Adaptor; gray	www.wago.com/209-128
	Item no.: 209-183 Marker card; white	www.wago.com/209-183
	Item no.: 210-110 Fiber-tip pen	www.wago.com/210-110
	Item no.: 249-105 Group marker carrier; gray	www.wago.com/249-105
	Item no.: 793-501 WMB marking card; as card; not stretchable; plain; snap-on type; white	www.wago.com/793-501
	Item no.: 793-501/000-002 WMB marking card; as card; not stretchable; plain; snap-on type; yellow	www.wago.com/793-501/000-002

Subject to changes. Please also observe the further product documentation!



Item no.: 793-501/000-005
WMB marking card; as card; not stretchable; plain; snap-on type; red

www.wago.com/793-501/000-005



Item no.: 793-501/000-006
WMB marking card; as card; not stretchable; plain; snap-on type; blue

www.wago.com/793-501/000-006



Item no.: 793-501/000-007
WMB marking card; as card; not stretchable; plain; snap-on type; gray

www.wago.com/793-501/000-007



Item no.: 793-501/000-012
WMB marking card; as card; not stretchable; plain; snap-on type; orange

www.wago.com/793-501/000-012



Item no.: 793-501/000-017
WMB marking card; as card; not stretchable; plain; snap-on type; light green

www.wago.com/793-501/000-017



Item no.: 793-501/000-023
WMB marking card; as card; not stretchable; plain; snap-on type; green

www.wago.com/793-501/000-023



Item no.: 793-501/000-024
WMB marking card; as card; not stretchable; plain; snap-on type; violet

www.wago.com/793-501/000-024



Item no.: 793-502
WMB marking card; as card; MARKED; 1 ... 10 (10x); not stretchable; Horizontal marking; snap-on type; white

www.wago.com/793-502



Item no.: 793-502/000-002
WMB marking card; as card; MARKED; 1 ... 10 (10x); not stretchable; Horizontal marking; snap-on type; yellow

www.wago.com/793-502/000-002



Item no.: 793-502/000-005
WMB marking card; as card; MARKED; 1 ... 10 (10x); not stretchable; Horizontal marking; snap-on type; red

www.wago.com/793-502/000-005



Item no.: 793-502/000-006
WMB marking card; as card; MARKED; 1 ... 10 (10x); not stretchable; Horizontal marking; snap-on type; blue

www.wago.com/793-502/000-006



Item no.: 793-502/000-007
WMB marking card; as card; MARKED; 1 ... 10 (10x); not stretchable; Horizontal marking; snap-on type; gray

www.wago.com/793-502/000-007



Item no.: 793-502/000-012
WMB marking card; as card; MARKED; 1 ... 10 (10x); not stretchable; Horizontal marking; snap-on type; orange

www.wago.com/793-502/000-012



Item no.: 793-502/000-017
WMB marking card; as card; MARKED; 1 ... 10 (10x); not stretchable; Horizontal marking; snap-on type;

www.wago.com/793-502/000-017

Subject to changes. Please also observe the further product documentation!

light green

**Item no.: 793-502/000-023**

WMB marking card; as card; MARKED; 1 ... 10 (10x); not stretchable; Horizontal marking; snap-on type; green

www.wago.com/793-502/000-023**Item no.: 793-502/000-024**

WMB marking card; as card; MARKED; 1 ... 10 (10x); not stretchable; Horizontal marking; snap-on type; violet

www.wago.com/793-502/000-024**Item no.: 793-503**

WMB marking card; as card; MARKED; 11 ... 20 (10x); not stretchable; Horizontal marking; snap-on type; white

www.wago.com/793-503**Item no.: 793-503/000-002**

WMB marking card; as card; MARKED; 11 ... 20 (10x); not stretchable; Horizontal marking; snap-on type; yellow

www.wago.com/793-503/000-002**Item no.: 793-503/000-005**

WMB marking card; as card; MARKED; 11 ... 20 (10x); not stretchable; Horizontal marking; snap-on type; red

www.wago.com/793-503/000-005**Item no.: 793-503/000-006**

WMB marking card; as card; MARKED; 11 ... 20 (10x); not stretchable; Horizontal marking; snap-on type; blue

www.wago.com/793-503/000-006**Item no.: 793-503/000-007**

WMB marking card; as card; MARKED; 11 ... 20 (10x); not stretchable; Horizontal marking; snap-on type; gray

www.wago.com/793-503/000-007**Item no.: 793-503/000-012**

WMB marking card; as card; MARKED; 11 ... 20 (10x); not stretchable; Horizontal marking; snap-on type; orange

www.wago.com/793-503/000-012**Item no.: 793-503/000-017**

WMB marking card; as card; MARKED; 11 ... 20 (10x); not stretchable; Horizontal marking; snap-on type; light green

www.wago.com/793-503/000-017**Item no.: 793-503/000-023**

WMB marking card; as card; MARKED; 11 ... 20 (10x); not stretchable; Horizontal marking; snap-on type; green

www.wago.com/793-503/000-023**Item no.: 793-503/000-024**

WMB marking card; as card; MARKED; 11 ... 20 (10x); not stretchable; Horizontal marking; snap-on type; violet

www.wago.com/793-503/000-024**Item no.: 793-504**

WMB marking card; as card; MARKED; 21 ... 30 (10x); not stretchable; Horizontal marking; snap-on type; white

www.wago.com/793-504**Item no.: 793-504/000-002**

WMB marking card; as card; MARKED; 21 ... 30 (10x); not stretchable; Horizontal marking; snap-on type; yellow

www.wago.com/793-504/000-002**Item no.: 793-504/000-005**

Subject to changes. Please also observe the further product documentation!

WAGO Kontakttechnik GmbH & Co. KG

Hansastr. 27

32423 Minden

Phone: +49571 887-0 | Fax: +49571 887-169

Email: info.de@wago.com | Web: www.wago.com

Do you have any questions about our products?

We are always happy to take your call at +49 (571) 887-44222.



WMB marking card; as card; MARKED; 21 ... 30 (10x); not stretchable; Horizontal marking; snap-on type; www.wago.com/793-504/000-005
red



Item no.: 793-504/000-006
WMB marking card; as card; MARKED; 21 ... 30 (10x); not stretchable; Horizontal marking; snap-on type; www.wago.com/793-504/000-006
blue



Item no.: 793-504/000-012
WMB marking card; as card; MARKED; 21 ... 30 (10x); not stretchable; Horizontal marking; snap-on type; www.wago.com/793-504/000-012
orange



Item no.: 793-504/000-017
WMB marking card; as card; MARKED; 21 ... 30 (10x); not stretchable; Horizontal marking; snap-on type; www.wago.com/793-504/000-017
light green



Item no.: 793-504/000-023
WMB marking card; as card; MARKED; 21 ... 30 (10x); not stretchable; Horizontal marking; snap-on type; www.wago.com/793-504/000-023
green



Item no.: 793-505
WMB marking card; as card; MARKED; 31 ... 40 (10x); not stretchable; Horizontal marking; snap-on type; www.wago.com/793-505
white



Item no.: 793-505/000-005
WMB marking card; as card; MARKED; 31 ... 40 (10x); not stretchable; Horizontal marking; snap-on type; www.wago.com/793-505/000-005
red



Item no.: 793-505/000-006
WMB marking card; as card; MARKED; 31 ... 40 (10x); not stretchable; Horizontal marking; snap-on type; www.wago.com/793-505/000-006
blue



Item no.: 793-505/000-007
WMB marking card; as card; MARKED; 31 ... 40 (10x); not stretchable; Horizontal marking; snap-on type; www.wago.com/793-505/000-007
gray



Item no.: 793-505/000-012
WMB marking card; as card; MARKED; 31 ... 40 (10x); not stretchable; Horizontal marking; snap-on type; www.wago.com/793-505/000-012
orange



Item no.: 793-506
WMB marking card; as card; MARKED; 41 ... 50 (10x); not stretchable; Horizontal marking; snap-on type; www.wago.com/793-506
white



Item no.: 793-506/000-005
WMB marking card; as card; MARKED; 41 ... 50 (10x); not stretchable; Horizontal marking; snap-on type; www.wago.com/793-506/000-005
red















Item no.: 793-506/000-006
WMB marking card; as card; MARKED; 41 ... 50 (10x); not stretchable; Horizontal marking; snap-on type; www.wago.com/793-506/000-006
blue



Item no.: 793-506/000-012
WMB marking card; as card; MARKED; 41 ... 50 (10x); not stretchable; Horizontal marking; snap-on type; www.wago.com/793-506/000-012
orange

Subject to changes. Please also observe the further product documentation!

	<p>Item no.: 793-506/000-017 WMB marking card; as card; MARKED; 41 ... 50 (10x); not stretchable; Horizontal marking; snap-on type; light green</p>	www.wago.com/793-506/000-017
	<p>Item no.: 793-5501 WMB marking card; as card; for terminal block width 5 - 17.5 mm; stretchable 5 - 5.2 mm; plain; snap-on type; white</p>	www.wago.com/793-5501
	<p>Item no.: 793-5501/000-002 WMB marking card; as card; for terminal block width 5 - 17.5 mm; stretchable 5 - 5.2 mm; plain; snap-on type; yellow</p>	www.wago.com/793-5501/000-002
	<p>Item no.: 793-5501/000-005 WMB marking card; as card; for terminal block width 5 - 17.5 mm; stretchable 5 - 5.2 mm; plain; snap-on type; red</p>	www.wago.com/793-5501/000-005
	<p>Item no.: 793-5501/000-006 WMB marking card; as card; for terminal block width 5 - 17.5 mm; stretchable 5 - 5.2 mm; plain; snap-on type; blue</p>	www.wago.com/793-5501/000-006
	<p>Item no.: 793-5501/000-007 WMB marking card; as card; for terminal block width 5 - 17.5 mm; stretchable 5 - 5.2 mm; plain; snap-on type; gray</p>	www.wago.com/793-5501/000-007
	<p>Item no.: 793-5501/000-012 WMB marking card; as card; for terminal block width 5 - 17.5 mm; stretchable 5 - 5.2 mm; plain; snap-on type; orange</p>	www.wago.com/793-5501/000-012
	<p>Item no.: 793-5501/000-014 WMB marking card; as card; for terminal block width 5 - 17.5 mm; stretchable 5 - 5.2 mm; plain; snap-on type; brown</p>	www.wago.com/793-5501/000-014
	<p>Item no.: 793-5501/000-017 WMB marking card; as card; for terminal block width 5 - 17.5 mm; stretchable 5 - 5.2 mm; plain; snap-on type; green</p>	www.wago.com/793-5501/000-017
	<p>Item no.: 793-5501/000-023 WMB marking card; as card; for terminal block width 5 - 17.5 mm; stretchable 5 - 5.2 mm; plain; snap-on type; light green</p>	www.wago.com/793-5501/000-023
	<p>Item no.: 793-5501/000-024 WMB marking card; as card; for terminal block width 5 - 17.5 mm; stretchable 5 - 5.2 mm; plain; snap-on type; violet</p>	www.wago.com/793-5501/000-024
	<p>Item no.: 793-566 WMB marking card; as card; MARKED; 1 ... 50 (2x); not stretchable; Horizontal marking; snap-on type; white</p>	www.wago.com/793-566
	<p>Item no.: 793-566/000-002 WMB marking card; as card; MARKED; 1 ... 50 (2x); not stretchable; Horizontal marking; snap-on type; yellow</p>	www.wago.com/793-566/000-002
	<p>Item no.: 793-566/000-005 WMB marking card; as card; MARKED; 1 ... 50 (2x); not stretchable; Horizontal marking; snap-on type;</p>	

Subject to changes. Please also observe the further product documentation!



red

www.wago.com/793-566/000-005
**Item no.: 793-566/000-006**

WMB marking card; as card; MARKED; 1 ... 50 (2x); not stretchable; Horizontal marking; snap-on type; blue

www.wago.com/793-566/000-006
**Item no.: 793-566/000-007**

WMB marking card; as card; MARKED; 1 ... 50 (2x); not stretchable; Horizontal marking; snap-on type; gray

www.wago.com/793-566/000-007
**Item no.: 793-566/000-012**

WMB marking card; as card; MARKED; 1 ... 50 (2x); not stretchable; Horizontal marking; snap-on type; orange

www.wago.com/793-566/000-012
**Item no.: 793-566/000-017**

WMB marking card; as card; MARKED; 1 ... 50 (2x); not stretchable; Horizontal marking; snap-on type; light green

www.wago.com/793-566/000-017
**Item no.: 793-566/000-023**

WMB marking card; as card; MARKED; 1 ... 50 (2x); not stretchable; Horizontal marking; snap-on type; green

www.wago.com/793-566/000-023
**Item no.: 793-566/000-024**

WMB marking card; as card; MARKED; 1 ... 50 (2x); not stretchable; Horizontal marking; snap-on type; violet

www.wago.com/793-566/000-024
Downloads**Documentation****Bid Text**

857-358 GAEB X81 - Datei	Feb 19, 2019	xml 4.8 kB	Download
-----------------------------	--------------	---------------	----------

857-358 GAEB docx - Datei	Feb 20, 2019	docx 17.0 kB	Download
------------------------------	--------------	-----------------	----------

Instruction Leaflet

Relaisbaustein mit steckbarem Kleinschaltrelais 1 Wechsler (1u) Eingangsnennspannung AC/DC 230 V		pdf 2.4 MB	Download
---	--	---------------	----------

Elektromechanical and Solid-State Relays/Optocouplers	V 1.4.0 Oct 15, 2019	pdf 2.4 MB	Download
---	-------------------------	---------------	----------

Subject to changes. Please also observe the further product documentation!

CAD/CAE-Data

CAD data

2D/3D Models 857-358	URL	Download
----------------------	---------------------	--------------------------

CAE data

EPLAN Data Portal 857-358	URL	Download
---------------------------	---------------------	--------------------------

WSCAD Universe 857-358	URL	Download
------------------------	---------------------	--------------------------

ZUKEN Portal 857-358	URL	Download
----------------------	---------------------	--------------------------

Installation Notes

Conductor termination

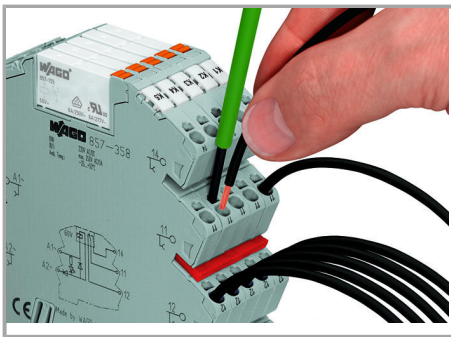

Connection of conductor

Commoning

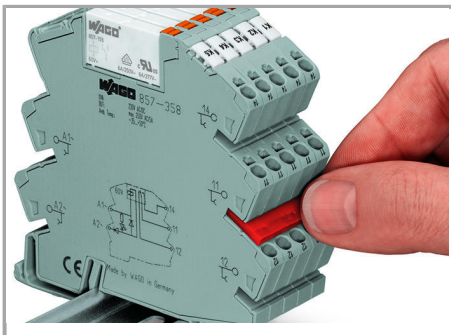

Easy commoning using adjacent jumpers

Marking

Subject to changes. Please also observe the further product documentation!



Marking using WMB Multi markers

Installation

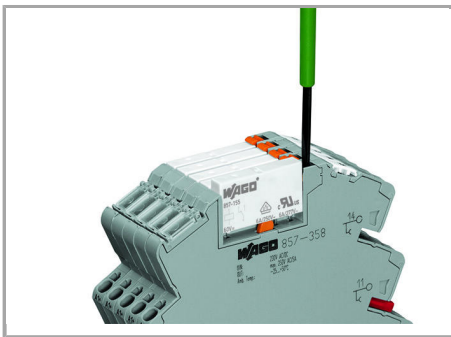

Operation of the relay ejector

Subject to changes. Please also observe the further product documentation!