

OMNIMATE Signal - series BL/SL 5.08 BLZ 5.08/05/270B SN OR BX

Weidmüller Interface GmbH & Co. KG
Klingenbergstraße 26
D-32758 Detmold
Germany
Fon: +49 5231 14-0
Fax: +49 5231 14-292083
www.weidmueller.com

Product image



Similar to illustration

Do not use product for new developments

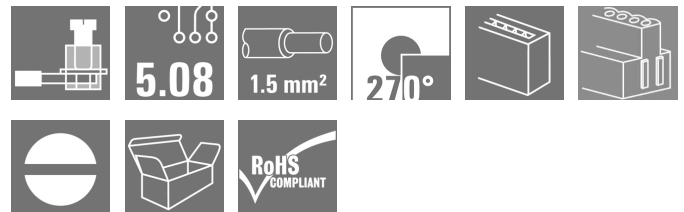

Female plugs with clamping-yoke screw connection.
The female plugs provide space for labelling and can be coded.

General ordering data

Delivery status	This article will no longer be available in the future.
Available until	2023-12-31
Type	BLZ 5.08/05/270B SN OR BX
Order No.	1559960000
Version	PCB plug-in connector, female plug, 5.08 mm, Number of poles: 5, 270°, Clamping yoke connection, Clamping range, max. : 3.31 mm², Box
GTIN (EAN)	4008190123253
Qty.	66 pc(s).
Product data	IEC: 400 V / 15 A / 0.2 - 2.5 mm²
Creation date	April 22, 2020 11:24:10 AM CEST
Packaging	Box
Alternative product	1950340000

Catalogue status 17.04.2020 / We reserve the right to make technical changes.

**OMNIMATE Signal - series BL/SL 5.08
BLZ 5.08/05/270B SN OR BX**

Weidmüller Interface GmbH & Co. KG
 Klingenbergstraße 26
 D-32758 Detmold
 Germany
 Fon: +49 5231 14-0
 Fax: +49 5231 14-292083
 www.weidmueller.com

Technical data**Dimensions and weights**

Width	27.4 mm	Width (inches)	1.079 inch
Height	14.1 mm	Height (inches)	0.555 inch
Depth	26.9 mm	Depth (inches)	1.059 inch
Net weight	9.879 g		

System Parameters

Product family	OMNIMATE Signal - series BL/SL 5.08	Type of connection	Field connection
Wire connection method	Clamping yoke connection	Pitch in mm (P)	5.08 mm
Pitch in inches (P)	0.2 inch	Conductor outlet direction	270°
Number of poles	5	L1 in mm	20.32 mm
L1 in inches	0.8 inch	Number of rows	1
Pin series quantity	1	Rated cross-section	2.5 mm ²
Touch-safe protection acc. to DIN VDE 57 106	Safe from finger touch	Volume resistance	≤ 5mΩ
Can be coded	Yes	Stripping length	7 mm
Tightening torque, min.	0.4 Nm	Tightening torque, max.	0.5 Nm
Clamping screw	M 2.5	Screwdriver blade	0.6 x 3.5
Screwdriver blade standard	DIN 5264	Plugging cycles	25
Plugging force/pole, max.	8.5 N	Pulling force/pole, max.	6.5 N

Material data

Insulating material	PBT	Colour	orange
Colour chart (similar)	RAL 2000	Insulating material group	IIIa
Comparative Tracking Index (CTI)	≥ 200	Insulation strength	≥ 10 ⁸ Ω
UL 94 flammability rating	V-0	GWFI	960 °C
Contact material	Copper alloy	Contact surface	tinned
Layer structure of plug contact	4-8 μm Sn hot-dip tinned	Storage temperature, min.	-25 °C
Storage temperature, max.	50 °C	Max. relative humidity during storage	70 %
Operating temperature, min.	-50 °C	Operating temperature, max.	100 °C
Temperature range, installation, min.	-25 °C	Temperature range, installation, max.	100 °C

Conductors suitable for connection

Clamping range, min.	0.13 mm ²
Clamping range, max.	3.31 mm ²
Wire connection cross section AWG, min.	AWG 26
Wire connection cross section AWG, max.	AWG 12
Solid, min. H05(07) V-U	0.2 mm ²
Solid, max. H05(07) V-U	2.5 mm ²
Flexible, min. H05(07) V-K	0.2 mm ²
Flexible, max. H05(07) V-K	2.5 mm ²
w. plastic collar ferrule, DIN 46228 pt 4, min.	0.2 mm ²
w. plastic collar ferrule, DIN 46228 pt 4, max.	2.5 mm ²
w. wire end ferrule, DIN 46228 pt 1, min.	0.2 mm ²
w. wire end ferrule, DIN 46228 pt 1, max.	2.5 mm ²
Plug gauge in accordance with EN 60999 a x b; ø	2.8 mm x 2.0 mm; 2.4 mm

Creation date April 22, 2020 11:24:10 PM CEST

**OMNIMATE Signal - series BL/SL 5.08
BLZ 5.08/05/270B SN OR BX**

Weidmüller Interface GmbH & Co. KG
 Klingenbergstraße 26
 D-32758 Detmold
 Germany
 Fon: +49 5231 14-0
 Fax: +49 5231 14-292083
 www.weidmueller.com

Technical data

Clampable conductor	Cross-section for conductor connection	Type	fine-wired
		nominal	0.5 mm ²
wire end ferrule		Stripping length	nominal 6 mm
		Recommended wire-end ferrule	H0.5/6
Clampable conductor	Cross-section for conductor connection	Type	fine-wired
		nominal	1 mm ²
wire end ferrule		Stripping length	nominal 6 mm
		Recommended wire-end ferrule	H1.0/6
Clampable conductor	Cross-section for conductor connection	Type	fine-wired
		nominal	1.5 mm ²
wire end ferrule		Stripping length	nominal 7 mm
		Recommended wire-end ferrule	H1.5/7
Clampable conductor	Cross-section for conductor connection	Type	fine-wired
		nominal	2.5 mm ²
wire end ferrule		Stripping length	nominal 7 mm
		Recommended wire-end ferrule	H2.5/7
Clampable conductor	Cross-section for conductor connection	Type	fine-wired
		nominal	0.75 mm ²
wire end ferrule		Stripping length	nominal 6 mm
		Recommended wire-end ferrule	H0.75/6
Reference text	The outside diameter of the plastic collar should not be larger than the pitch (P). Length of ferrules is to be chosen depending on the product and the rated voltage.		
Max. clamping range	3.31 mm ²		

Rated data acc. to IEC

tested acc. to standard	IEC 60664-1, IEC 61984	Rated current, min. number of poles (Tu=20°C)	15 A
Rated current, max. number of poles (Tu=20°C)	12 A	Rated current, min. number of poles (Tu=40°C)	12 A
Rated current, max. number of poles (Tu=40°C)	10 A	Rated voltage for surge voltage class / pollution degree II/2	400 V
Rated voltage for surge voltage class / pollution degree III/2	320 V	Rated voltage for surge voltage class / pollution degree III/3	250 V
Rated impulse voltage for surge voltage class/ pollution degree II/2	4 kV	Rated impulse voltage for surge voltage class/ pollution degree III/2	4 kV
Rated impulse voltage for surge voltage class/ contamination degree III/3	4 kV	Short-time withstand current resistance	3 x 1s with 120 A

Rated data acc. to CSA

Institute (CSA)		Certificate No. (CSA)	200039-1121690
Rated voltage (Use group B / CSA)	300 V	Rated voltage (Use group D / CSA)	300 V
Rated current (Use group B / CSA)	10 A	Rated current (Use group D / CSA)	10 A
Wire cross-section, AWG, min.	AWG 26	Wire cross-section, AWG, max.	AWG 12
Reference to approval values	Specifications are maximum values, details - see approval certificate.		

Data sheet

**OMNIMATE Signal - series BL/SL 5.08
BLZ 5.08/05/270B SN OR BX**

Weidmüller Interface GmbH & Co. KG
Klingenbergstraße 26
D-32758 Detmold
Germany
Fon: +49 5231 14-0
Fax: +49 5231 14-292083
www.weidmueller.com

Technical data

Rated data acc. to UL 1059

Institute (UR)		Certificate No. (UR)	E60693
Rated voltage (Use group B / UL 1059)	300 V	Rated voltage (Use group D / UL 1059)	300 V
Rated current (Use group B / UL 1059)	10 A	Rated current (Use group D / UL 1059)	10 A
Wire cross-section, AWG, min.	AWG 26	Wire cross-section, AWG, max.	AWG 12
Reference to approval values	Specifications are maximum values, details - see approval certificate.		

Packing

Packaging	Box	VPE length	30 mm
VPE width	135 mm	VPE height	350 mm

Classifications

ETIM 6.0	EC002638	ETIM 7.0	EC002638
eClass 9.0	27-44-03-09	eClass 9.1	27-44-03-09
eClass 10.0	27-44-03-09	UNSPSC	30-21-18-10

Notes

Notes	<ul style="list-style-type: none"> • Additional colours on request • Gold-plated contact surfaces on request • Rated current related to rated cross-section & min. No. of poles. • Wire end ferrule without plastic collar to DIN 46228/1 • Wire end ferrule with plastic collar to DIN 46228/4 • P on drawing = pitch • Rated data refer only to the component itself. Clearance and creepage distances to other components are to be designed in accordance with the relevant application standards.
IPC conformity	Conformity: The products are developed, manufactured and delivered according international recognized standards and norms and comply with the assured properties in the data sheet resp. fulfill decorative properties in accordance with IPC-A-610 "Class 2". Further claims on the products can be evaluated on request.

Approvals

Approvals	
ROHS	Conform

**OMNIMATE Signal - series BL/SL 5.08
BLZ 5.08/05/270B SN OR BX**

Weidmüller Interface GmbH & Co. KG
Klingenbergstraße 26
D-32758 Detmold
Germany
Fon: +49 5231 14-0
Fax: +49 5231 14-292083
www.weidmueller.com

Technical data**Downloads**

Approval/Certificate/Document of
Conformity

[Declaration of the Manufacturer](#)

Brochure/Catalogue

[FL DRIVES EN](#)
[MB DEVICE MANUF. EN](#)
[FL DRIVES DE](#)
[FL BUILDING SAFETY EN](#)
[FL APPL LED LIGHTING EN](#)
[FLIndustr.CONTROLS EN](#)
[FL MACHINE SAFETY EN](#)
[FL HEATING ELECTR EN](#)
[FL APPL INVERTER EN](#)
[FL_BASE_STATION_EN](#)
[FL ELEVATOR EN](#)
[FL POWER SUPPLY EN](#)
[FL 72H SAMPLE SER EN](#)
[PO OMNIMATE EN](#)

Data sheet**OMNIMATE Signal - series BL/SL 5.08
BLZ 5.08/05/270B SN OR BX**

Weidmüller Interface GmbH & Co. KG
Klingenbergstraße 26
D-32758 Detmold
Germany
Fon: +49 5231 14-0
Fax: +49 5231 14-292083
www.weidmueller.com

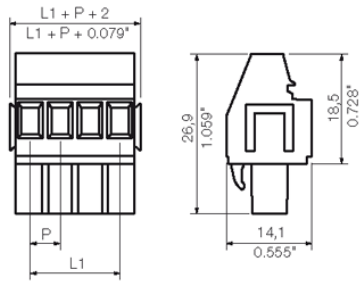
Drawings**Dimensional drawing**

MASSE OHNE TOLERANZ SIND KEINE PRUEFMASSE
 DIMS. WITHOUT TOLERANCE ARE NOT CONTROL DIMS.

DIE DEUTSCHE VERSION IST VERBINDLICH
 THE GERMAN VERSION IS BINDING

WEITERGABE SOWIE VERVIELFAELTIGUNG DIESES DOKUMENTS, VERWERTUNG UND MITTEILUNG SEINES INHALTS SIND VERBOTEN, SOWEIT NICHT AUSDRUECKLICH GESTATTET.
 ZUWIDERHANDLUNGEN VERPFLICHTEN ZU SCHADENERSATZ. ALLE RECHTE FUER DEN FALL DER PATENT-, GEBRAUCHSMUSTER- ODER GESCHMACKSMUSTEREINTRAGUNG VORBEHALTEN.
 THE REPRODUCTION, DISTRIBUTION AND UTILIZATION OF THIS DOCUMENT AS WELL AS THE COMMUNICATION OF ITS CONTENTS TO OTHERS WITHOUT EXPLICIT AUTHORIZATION IS PROHIBITED.
 OFFENDERS WILL BE HELD LIABLE FOR THE PAYMENT OF DAMAGES. WEIDMUELLER EXCLUSIVELY RESERVES THE RIGHT TO FILE FOR PATENTS, UTILITY MODELS OR DESIGNS.
 © WEIDMUELLER INTERFACE GmbH & Co.KG

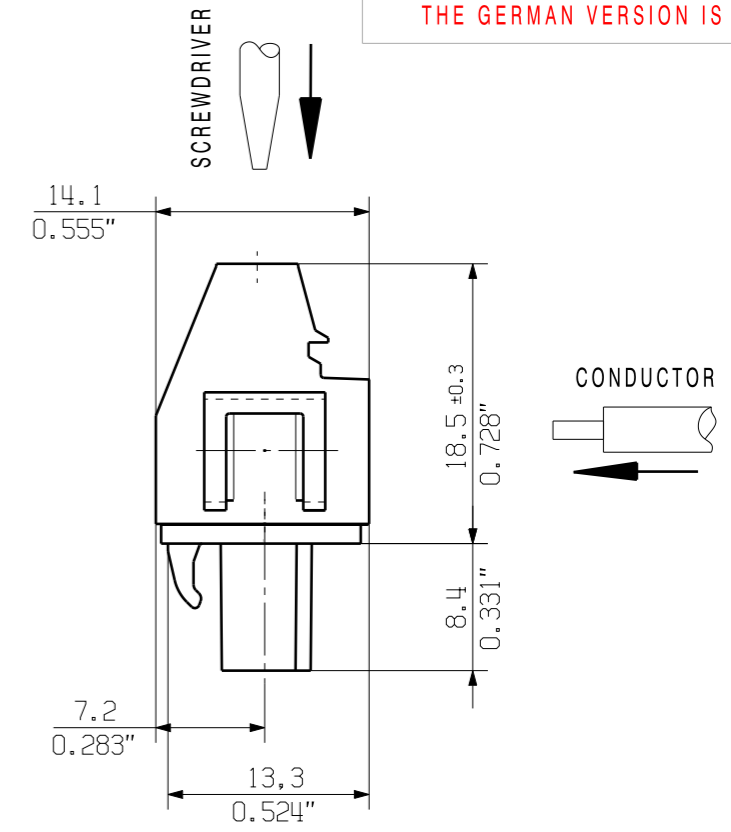
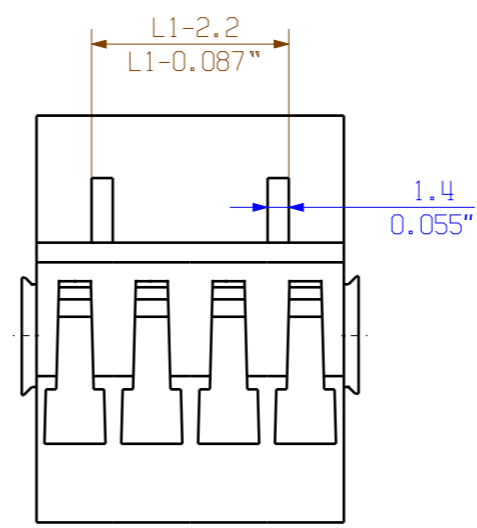
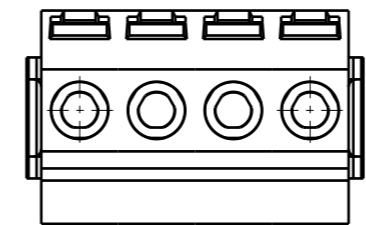
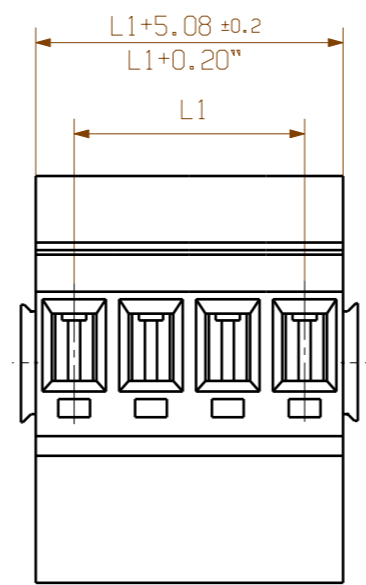

24	116,84	4,60
23	111,76	4,40
22	106,68	4,20
21	101,60	4,00
20	96,52	3,80
19	91,44	3,60
18	86,36	3,40
17	81,28	3,20
16	76,20	3,00
15	71,12	2,80
14	66,04	2,60
13	60,96	2,40
12	55,88	2,20
11	50,80	2,00
10	45,72	1,80
9	40,64	1,60
8	35,56	1,40
7	30,48	1,20
6	25,40	1,00
5	20,32	0,80
4	15,24	0,60
3	10,16	0,40
2	5,08	0,20
n	L1 [mm]	L1 [inch]

shown: BLZ 5.08/4/90B

For the mounting of PCBs, it should be noted that the rated data given in the catalogue relates only to the connection elements. The necessary creepage and clearance paths must be observed in connection with the respective applicant in accordance to VDE 0110. The current-carrying capacity and pitch tolerance is to be determined according to DIN IEC 326 part 3 very fine.

Weidmüller connectors are tested to the DIN VDE 0627 standard, and are valid for its field of application. Provided that the connectors are used to the intended purpose, all requirements with respect to the occurring of electrical, mechanical, thermic and corrosive stress will be satisfied.

	METRIC TOLERANCES: X. = ±0.3 X.X = ±0.1 X.XX = ±0.05		CAT.NO.: C 16662 34	
	50351/0 15.03.10 HELIS_MA 03		DRAWING NO. OF 03 SHEETS	
MODIFICATION				
		DATE	NAME	
SCALE: 2:1 SUPERSEDES: .		DRAWN	08.03.2010 HELIS_MA	
		RESPONSIBLE	HERTEL_S	
		CHECKED	17.03.2010 HECKERT_M	
		APPROVED	HECKERT_M	
		PRODUCT FILE: BLZ 5.08 90/270 7149		

BLZ 5.08/.. /270...
 BUCHSENLEISTE
 SOCKET BLOCK