

## OMNIMATE Signal - series LP LP 7.50/02/180 3.2SN OR BX

**Weidmüller Interface GmbH & Co. KG**  
Klingenbergstraße 16  
D-32758 Detmold  
Germany  
Fon: +49 5231 14-0  
Fax: +49 5231 14-292083  
www.weidmueller.com

### Product image

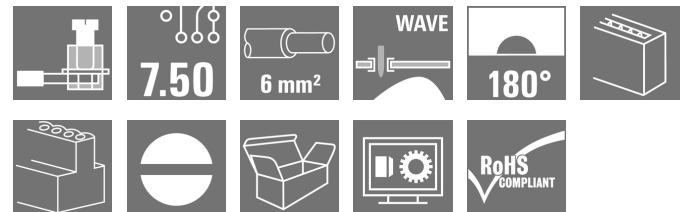

Similar to illustration

This PCB terminal provides connections for 1000 V, 6 mm<sup>2</sup> conductor cross-section and 32 A with proven clamping yoke connection at 7.50 mm and 7.62 mm pitch, conductor outlet direction in 90° and 180° design.

### General ordering data

Available until	2020-12-31
Type	LP 7.50/02/180 3.2SN OR BX
Order No.	<a href="#">1761370000</a>
Version	PCB terminal, 7.50 mm, No. of poles: 2, 180°, Solder pin length (l): 3.2 mm, tinned, Orange, Clamping yoke connection, Clamping range, max. : 6 mm <sup>2</sup> , Box
GTIN (EAN)	4032248121625
Qty.	100 pc(s).
Product data	IEC: 1000 V / 32 A / 0.5 - 6 mm <sup>2</sup> UL: 300 V / 20 A / AWG 26 - AWG 12
Packaging	Box

**OMNIMATE Signal - series LP  
LP 7.50/02/180 3.2SN OR BX**

**Weidmüller Interface GmbH & Co. KG**  
 Klingenbergstraße 16  
 D-32758 Detmold  
 Germany  
 Fon: +49 5231 14-0  
 Fax: +49 5231 14-292083  
 www.weidmueller.com

**Technical data****Dimensions and weights**

Width	15.6 mm	Width (inches)	0.614 inch
Height	14.2 mm	Height (inches)	0.559 inch
Height of lowest version	11 mm	Depth	19 mm
Depth (inches)	0.748 inch	Net weight	3.56 g

**System parameters**

Product family	OMNIMATE Signal - series LP	Wire connection method	Clamping yoke connection
Mounting onto the PCB	THT solder connection	Conductor outlet direction	180°
Pitch in mm (P)	7.5 mm	Pitch in inches (P)	0.295 inch
No. of poles	2	Fitted by customer	Yes
Max. adjacent poles per row	16	Solder pin length (l)	3.2 mm
Solder pin dimensions	0.75 x 0.9 mm	Solder eyelet hole diameter (D)	1.3 mm
Solder eyelet hole diameter tolerance (D)+ 0,1 mm		Number of solder pins per pole	1
Screwdriver blade	0.6 x 3.5	Screwdriver blade standard	DIN 5264
Tightening torque, min.	0.5 Nm	Tightening torque, max.	0.6 Nm
Clamping screw	M 3	Stripping length	6 mm
L1 in mm	7.5 mm	L1 in inches	0.295 inch
Touch-safe protection acc. to DIN VDE 0470	IP 10	Touch-safe protection acc. to DIN VDE 57 106	Safe from back-of-hand touch
Volume resistance	1.20 mΩ		

**Material data**

Insulating material	PA	Colour	Orange
Colour chart (similar)	RAL 2000	Insulating material group	I
CTI	≥ 600	Insulation resistance	≥ 10 <sup>8</sup> Ω
UL 94 flammability rating	V-2	Contact material	Copper alloy
Contact surface	tinned	Coating	1-3 μm Ni, 4-6 μm Sn
Tinning type	matt	Layer structure of solder connection	4-6 μm Ni / 4-6 μm Sn
Storage temperature, min.	-25 °C	Storage temperature, max.	55 °C
Max. relative humidity during storage	80 %	Operating temperature, min.	-50 °C
Operating temperature, max.	100 °C	Temperature range, installation, min.	-25 °C
Temperature range, installation, max.	100 °C		

**Conductors suitable for connection**

Clamping range, min.	0.13 mm <sup>2</sup>	Clamping range, max.	6 mm <sup>2</sup>
Wire connection cross section AWG, min.	AWG 26	Wire connection cross section AWG, max.	AWG 12
Solid, min. H05(07) V-U	0.5 mm <sup>2</sup>	Solid, max. H05(07) V-U	6 mm <sup>2</sup>
Stranded, max. H07V-R	6 mm <sup>2</sup>	Flexible, min. H05(07) V-K	0.5 mm <sup>2</sup>
Flexible, max. H05(07) V-K	4 mm <sup>2</sup>	w. plastic collar ferrule, DIN 46228 pt 4, min.	0.5 mm <sup>2</sup>
w. plastic collar ferrule, DIN 46228 pt 4, max.	2.5 mm <sup>2</sup>	w. wire end ferrule, DIN 46228 pt 1, min.	0.5 mm <sup>2</sup>
w. wire end ferrule, DIN 46228 pt 1, max.	2.5 mm <sup>2</sup>	Plug gauge in accordance with EN 60999 a x b; ø	2.8 mm x 2.4 mm; 3.0 mm

**OMNIMATE Signal - series LP  
LP 7.50/02/180 3.2SN OR BX**

**Weidmüller Interface GmbH & Co. KG**  
Klingenbergstraße 16  
D-32758 Detmold  
Germany  
Fon: +49 5231 14-0  
Fax: +49 5231 14-292083  
www.weidmueller.com

**Technical data****Rated data acc. to IEC**

tested acc. to standard	IEC 60664-1, IEC 61984	Rated current, min. no. of poles (Tu=20°C)	32 A
Rated current, max. no. of poles (Tu=20°C)	32 A	Rated current, min. no. of poles (Tu=40°C)	32 A
Rated current, max. no. of poles (Tu=40°C)	30.5 A	Rated voltage for surge voltage class / pollution degree II/2	1,000 V
Rated voltage for surge voltage class / pollution degree III/2	500 V	Rated voltage for surge voltage class / pollution degree III/3	500 V
Rated impulse voltage for surge voltage class/ pollution degree II/2	6 kV	Rated impulse voltage for surge voltage class/ pollution degree III/2	6 kV
Rated impulse voltage for surge voltage class/ contamination degree III/3	6 kV	Short-time withstand current resistance	3 x 1s with 120 A

**Rated data acc. to CSA**

Institute (CSA)		Certificate No. (CSA)	200039-1202191
Rated voltage (Use group B / CSA)	300 V	Rated voltage (Use group D / CSA)	300 V
Rated current (Use group B / CSA)	20 A	Rated current (Use group D / CSA)	10 A
Wire cross-section, AWG, min.	AWG 26	Wire cross-section, AWG, max.	AWG 12
Reference to approval values	Specifications are maximum values, details - see approval certificate.		

**Rated data acc. to UL 1059**

Institute (UR)		Certificate No. (UR)	E60693
Rated voltage (Use group B / UL 1059)	300 V	Rated voltage (Use group D / UL 1059)	300 V
Rated current (Use group B / UL 1059)	20 A	Rated current (Use group D / UL 1059)	10 A
Wire cross-section, AWG, min.	AWG 26	Wire cross-section, AWG, max.	AWG 12
Reference to approval values	Specifications are maximum values, details - see approval certificate.		

**Packaging**

Packaging	Box	VPE length	80 mm
VPE width	88 mm	VPE height	100 mm

**Classifications**

ETIM 3.0	EC001284	ETIM 4.0	EC002643
ETIM 5.0	EC002643	ETIM 6.0	EC002643
UNSPSC	30-21-18-01	eClass 6.2	27-26-11-01
eClass 7.1	27-44-04-01	eClass 8.1	27-44-04-01
eClass 9.0	27-44-04-01	eClass 9.1	27-44-04-01

**Data sheet**

**OMNIMATE Signal - series LP  
LP 7.50/02/180 3.2SN OR BX**

**Weidmüller Interface GmbH & Co. KG**  
Klingenbergstraße 16  
D-32758 Detmold  
Germany  
Fon: +49 5231 14-0  
Fax: +49 5231 14-292083  
www.weidmueller.com

**Technical data**

**Notes**

Notes	<ul style="list-style-type: none"> <li>• Additional colours on request</li> <li>• Rated current related to rated cross-section &amp; min. No. of poles.</li> <li>• Wire end ferrule without plastic collar to DIN 46228/1</li> <li>• Wire end ferrule with plastic collar to DIN 46228/4</li> <li>• P on drawing = pitch</li> <li>• Rated data refer only to the component itself. Clearance and creepage distances to other components are to be designed in accordance with the relevant application standards.</li> <li>• It is necessary to hold the insulating body of the one or two pole terminal when tightening the screw</li> </ul>
IPC conformity	Conformity: The products are developed, manufactured and delivered according international recognized standards and norms and comply with the assured properties in the data sheet resp. fulfill decorative properties in accordance with IPC-A-610 "Class 2". Further claims on the products can be evaluated on request.

**Approvals**

Approvals	
ROHS	Conform

**Downloads**

Approval/Certificate/Document of Conformity	<a href="#">Declaration of the Manufacturer</a>
Brochure/Catalogue	<a href="#">FL DRIVES EN</a> <a href="#">FL ANALO.SIGN.CONV. EN</a> <a href="#">MB DEVICE MANUF. EN</a> <a href="#">FL DRIVES DE</a> <a href="#">CAT 2 PORTFOLIOGUIDE EN</a> <a href="#">FL BUILDING SAFETY EN</a> <a href="#">FL APPL LED LIGHTING EN</a> <a href="#">FLIndustr.CONTROLS EN</a> <a href="#">FL MACHINE SAFETY EN</a> <a href="#">FL HEATING ELECTR EN</a> <a href="#">FL APPL INVERTER EN</a> <a href="#">FL BASE STATION EN</a> <a href="#">FL ELEVATOR EN</a> <a href="#">FL POWER SUPPLY EN</a> <a href="#">FL 72H SAMPLE SER EN</a> <a href="#">PO OMNIMATE EN</a>
Engineering Data	<a href="#">EPLAN.WSCAD</a>

**Data sheet**

**OMNIMATE Signal - series LP  
LP 7.50/02/180 3.2SN OR BX**

**Weidmüller Interface GmbH & Co. KG**  
 Klingenbergstraße 16  
 D-32758 Detmold  
 Germany  
 Fon: +49 5231 14-0  
 Fax: +49 5231 14-292083  
 www.weidmueller.com

**Drawings**

**Dimensional drawing**

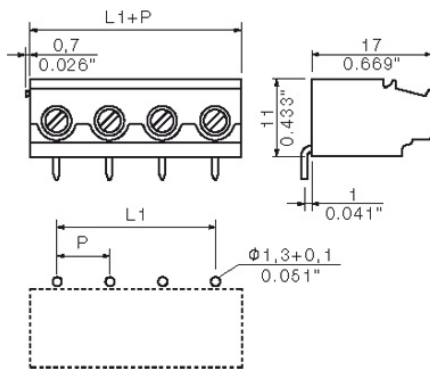

**Graph**

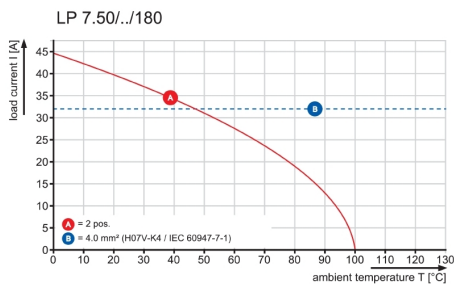

## Recommended wave soldering profiles

**Weidmüller Interface GmbH & Co. KG**  
 Klängenbergstraße 16  
 D-32758 Detmold  
 Germany  
 Fon: +49 5231 14-0  
 Fax: +49 5231 14-292083  
 www.weidmueller.com

### Single Wave:

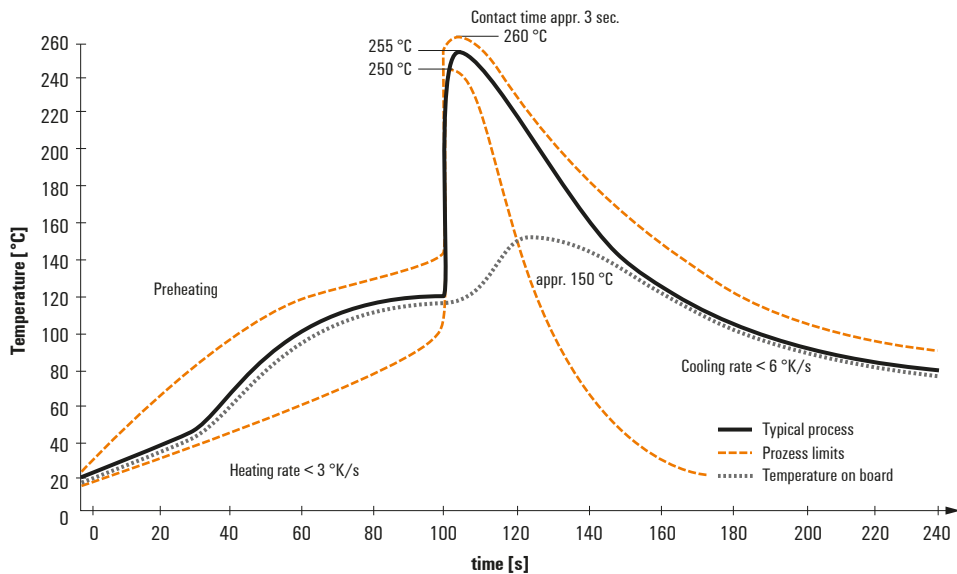

### Double Wave:

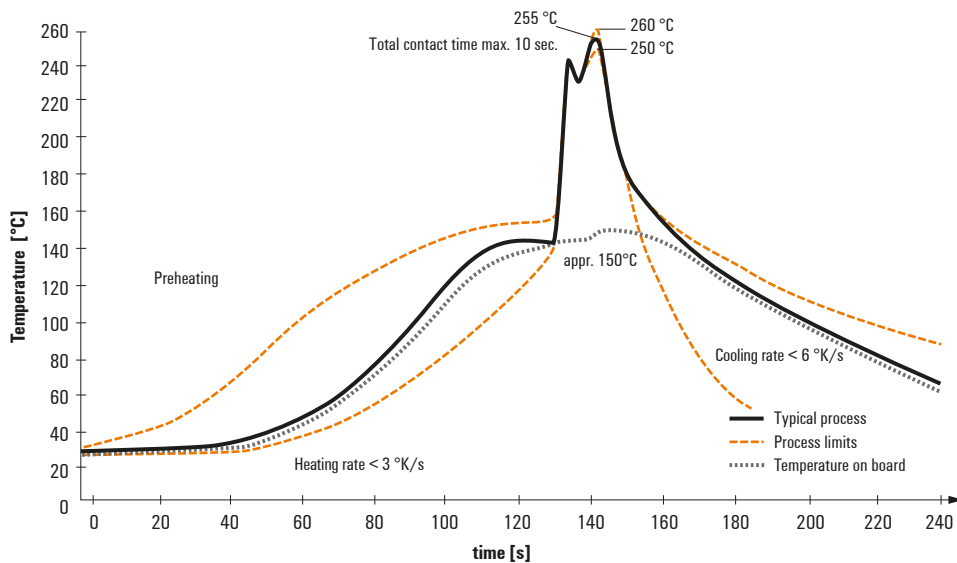

### Wave soldering profiles

Wired connection elements should be processed in accordance with the DIN EN 61760-1 standard. We have included two recommendations for practical wave soldering profiles, with which Weidmüller PCB terminals and connectors are qualified.

When choosing a suitable profile for your application, the following factors also need to be considered:

- PCB thickness
- Proportion of Cu in the layers
- Single/double-sided assembly
- Product range
- Heating and cooling rates

The single and double wave profiles each indicate the recommended operating range, including the maximum soldering temperature of 260°C. In practice, the maximum soldering temperature is quite often well below the above maximum profile.