

OMNIMATE Signal - series BC/SC 3.81 BCZ 3.81/16/270 SN BK BX

Weidmüller Interface GmbH & Co. KG
Klingenbergstraße 26
D-32758 Detmold
Germany
Fon: +49 5231 14-0
Fax: +49 5231 14-292083
www.weidmueller.com

Product image

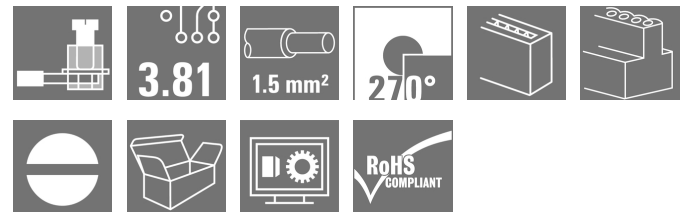
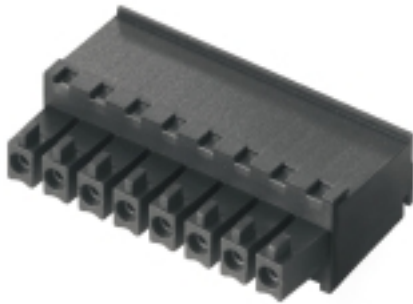

Similar to illustration

Female socket connectors with clamping-yoke screw system for connecting wires.

Three wire-outlet directions are available and provide flexible connection-level design options:

- 180° wire parallel to plugging direction
- 90° wire perpendicular and above plugging direction
- 270° wire perpendicular and below plugging direction

There are three housing shapes, covering many different requirements, to choose from:

- Standard housing without flange
- Flange with screw (F)
- Flange featuring Weidmüller's patented release latch (LR) for lock-and-release latching with no strain and no tools needed.

Weidmüller's 3.81-mm-pitch (0.15 inch) plug-in connectors are compatible with the layouts of customary connectors and offer space for labelling and coding.

General ordering data

| | |
|--------------|---|
| Type | BCZ 3.81/16/270 SN BK BX |
| Order No. | 1799000000 |
| Version | PCB plug-in connector, female plug, 3.81 mm, Number of poles: 16, 270°, Clamping yoke connection, Clamping range, max. : 1.5 mm², Box |
| GTIN (EAN) | 4032248243792 |
| Qty. | 50 pc(s). |
| Product data | IEC: 320 V / 17.5 A / 0.2 - 1.5 mm² UL: 300 V / 10 A / AWG 28 - AWG 16 |
| Packaging | Box |

**OMNIMATE Signal - series BC/SC 3.81
BCZ 3.81/16/270 SN BK BX**

Weidmüller Interface GmbH & Co. KG
 Klingenbergstraße 26
 D-32758 Detmold
 Germany
 Fon: +49 5231 14-0
 Fax: +49 5231 14-292083
 www.weidmueller.com

Technical data**Dimensions and weights**

| | | | |
|------------|---------|-----------------|------------|
| Width | 60.96 | Width (inches) | 2.4 inch |
| Height | 10.5 mm | Height (inches) | 0.413 inch |
| Depth | 19.1 mm | Depth (inches) | 0.752 inch |
| Net weight | 14.14 g | | |

Environmental Product Compliance

| | |
|------------|----------------|
| REACH SVHC | Lead 7439-92-1 |
|------------|----------------|

System Parameters

| | | | |
|--|-------------------------------------|--|-------------------|
| Product family | OMNIMATE Signal - series BC/SC 3.81 | Type of connection | Field connection |
| Wire connection method | Clamping yoke connection | Pitch in mm (P) | 3.81 mm |
| Pitch in inches (P) | 0.15 inch | Conductor outlet direction | 270° |
| Number of poles | 16 | L1 in mm | 57.15 mm |
| L1 in inches | 2.25 inch | Number of rows | 1 |
| Pin series quantity | 1 | Rated cross-section | 1 mm ² |
| Touch-safe protection acc. to DIN VDE 57 106 | Safe from finger touch | Touch-safe protection acc. to DIN VDE 0470 | IP 20 |
| Volume resistance | ≤ 5mΩ | Can be coded | Yes |
| Stripping length | 7 mm | Tightening torque, min. | 0.2 Nm |
| Tightening torque, max. | 0.25 Nm | Clamping screw | M 2 |
| Screwdriver blade | 0.4 x 2.5 | Screwdriver blade standard | DIN 5264 |
| Plugging cycles | 25 | Plugging force/pole, max. | 7 N |
| Pulling force/pole, max. | 5 N | | |

Material data

| | | | |
|---------------------------------------|-------------------------------|---------------------------------------|---------------------|
| Insulating material | PA 66 GF 30 | Colour | black |
| Colour chart (similar) | RAL 9011 | Insulating material group | II |
| Comparative Tracking Index (CTI) | ≥ 550 | Insulation strength | ≥ 10 ⁸ Ω |
| UL 94 flammability rating | V-0 | GWFI | 960 °C |
| Contact material | Copper alloy | Contact surface | tinned |
| Layer structure of plug contact | 0.5...1.5 μm Cu / 2...5 μm Sn | Storage temperature, min. | -40 °C |
| Storage temperature, max. | 70 °C | Operating temperature, min. | -50 °C |
| Operating temperature, max. | 120 °C | Temperature range, installation, min. | -25 °C |
| Temperature range, installation, max. | 120 °C | | |

Conductors suitable for connection

| | |
|---|----------------------|
| Clamping range, min. | 0.08 mm ² |
| Clamping range, max. | 1.5 mm ² |
| Wire connection cross section AWG, min. | AWG 28 |
| Wire connection cross section AWG, max. | AWG 16 |
| Solid, min. H05(07) V-U | 0.2 mm ² |
| Solid, max. H05(07) V-U | 1.5 mm ² |
| Flexible, min. H05(07) V-K | 0.2 mm ² |
| Flexible, max. H05(07) V-K | 1.5 mm ² |
| w. plastic collar ferrule, DIN 46228 pt 4, 0.2 mm ² min. | |
| w. plastic collar ferrule, DIN 46228 pt 4, 1.5 mm ² max. | |

Creation date August 17, 2020 11:45:35 PM CEST

**OMNIMATE Signal - series BC/SC 3.81
BCZ 3.81/16/270 SN BK BX**

Weidmüller Interface GmbH & Co. KG
Klingenbergstraße 26
D-32758 Detmold
Germany
Fon: +49 5231 14-0
Fax: +49 5231 14-292083
www.weidmueller.com

Technical data

| | | | | |
|---|--|--|-------------------------|------|
| w. wire end ferrule, DIN 46228 pt 1, min. | 0.2 mm ² | | | |
| w. wire end ferrule, DIN 46228 pt 1, max. | 1.5 mm ² | | | |
| Plug gauge in accordance with EN 60999 a x b; ø | 2.4 mm x 1.5 mm ; 2.4 mm | | | |
| Clampable conductor | Cross-section for conductor connection | Type | fine-wired | |
| | | nominal | 0.5 mm ² | |
| | wire end ferrule | Stripping length | nominal | 6 mm |
| | | Recommended wire-end ferrule | H0.5/6 | |
| | Cross-section for conductor connection | Type | fine-wired | |
| | | nominal | 0.75 mm ² | |
| | wire end ferrule | Stripping length | nominal | 6 mm |
| | | Recommended wire-end ferrule | H0.75/6 | |
| | Cross-section for conductor connection | Type | fine-wired | |
| | | nominal | 1 mm ² | |
| | wire end ferrule | Stripping length | nominal | 6 mm |
| | | Recommended wire-end ferrule | H1.0/6 | |
| | Cross-section for conductor connection | Type | fine-wired | |
| | | nominal | 1.5 mm ² | |
| | wire end ferrule | Stripping length | nominal | 7 mm |
| | | Recommended wire-end ferrule | H1.5/7 | |
| | Reference text | The outside diameter of the plastic collar should not be larger than the pitch (P), Length of ferrules is to be chosen depending on the product and the rated voltage. | | |
| | Max. clamping range | 1.5 mm ² | | |

Rated data acc. to IEC

| | | | |
|---|------------------------|---|------------------|
| tested acc. to standard | IEC 60664-1, IEC 61984 | Rated current, min. number of poles (Tu=20°C) | 17.5 A |
| Rated current, max. number of poles (Tu=20°C) | 15.9 A | Rated current, min. number of poles (Tu=40°C) | 17.5 A |
| Rated current, max. number of poles (Tu=40°C) | 14.1 A | Rated voltage for surge voltage class / pollution degree II/2 | 320 V |
| Rated voltage for surge voltage class / pollution degree III/2 | 160 V | Rated voltage for surge voltage class / pollution degree III/3 | 160 V |
| Rated impulse voltage for surge voltage class/ pollution degree II/2 | 2.5 kV | Rated impulse voltage for surge voltage class/ pollution degree III/2 | 2.5 kV |
| Rated impulse voltage for surge voltage class/ contamination degree III/3 | 2.5 kV | Short-time withstand current resistance | 3 x 1s with 76 A |

Rated data acc. to CSA

| | | | |
|-----------------------------------|--|-----------------------------------|----------------|
| Institute (CSA) | | Certificate No. (CSA) | 200039-1121690 |
| Rated voltage (Use group B / CSA) | 300 V | Rated voltage (Use group C / CSA) | 50 V |
| Rated current (Use group B / CSA) | 8 A | Rated current (Use group C / CSA) | 8 A |
| Wire cross-section, AWG, min. | AWG 28 | Wire cross-section, AWG, max. | AWG 16 |
| Reference to approval values | Specifications are maximum values, details - see approval certificate. | | |

Data sheet

**OMNIMATE Signal - series BC/SC 3.81
BCZ 3.81/16/270 SN BK BX**

Weidmüller Interface GmbH & Co. KG
Klingenbergstraße 26
D-32758 Detmold
Germany
Fon: +49 5231 14-0
Fax: +49 5231 14-292083
www.weidmueller.com

Technical data

Rated data acc. to UL 1059

Institute (cURus)



Certificate No. (cURus)

E60693

| | | | |
|---------------------------------------|--|---------------------------------------|--------|
| Rated voltage (Use group B / UL 1059) | 300 V | Rated voltage (Use group D / UL 1059) | 300 V |
| Rated current (Use group B / UL 1059) | 10 A | Rated current (Use group D / UL 1059) | 10 A |
| Wire cross-section, AWG, min. | AWG 28 | Wire cross-section, AWG, max. | AWG 16 |
| Reference to approval values | Specifications are maximum values, details - see approval certificate. | | |

Packing

| | | | |
|-----------|-------|------------|--------|
| Packaging | Box | VPE length | 60 mm |
| VPE width | 65 mm | VPE height | 215 mm |

Type tests

| | | |
|--|------------|---|
| Test: Durability of markings | Standard | DIN EN 61984 section 7.3.2 / 09.02 taking pattern from DIN EN 60068-2-70 / 07.96 |
| | Test | mark of origin, type identification, rated voltage, rated cross-section, pitch, type of material, approval marking UL, approval marking CSA |
| | Evaluation | available |
| | Test | durability |
| | Evaluation | passed |
| Test: Misengagement (Non-interchangeability) | Standard | DIN EN 61984 section 6.3 and 6.9.1 / 09.02, DIN EN 60512-13-5 / 11.06 |
| | Test | 180° turned without coding elements |
| | Evaluation | passed |
| | Test | visual examination |
| | Evaluation | passed |

**OMNIMATE Signal - series BC/SC 3.81
BCZ 3.81/16/270 SN BK BX**

Weidmüller Interface GmbH & Co. KG
Klingenbergstraße 26
D-32758 Detmold
Germany
Fon: +49 5231 14-0
Fax: +49 5231 14-292083
www.weidmueller.com

Technical data

| | | | |
|---|---|--|-------------------------------|
| Test: Clampable cross section | Standard | DIN EN 60999-1 section 7 and 9.1 / 12.00, DIN EN 60947-1 section 8.2.4.5.1 / 12.02 | |
| | Conductor type | Type of conductor and conductor cross-section | solid 0.08 mm ² |
| | | Type of conductor and conductor cross-section | stranded 0.08 mm ² |
| | | Type of conductor and conductor cross-section | solid 1.5 mm ² |
| | | Type of conductor and conductor cross-section | stranded 1.5 mm ² |
| | | Type of conductor and conductor cross-section | AWG 28/1 |
| | | Type of conductor and conductor cross-section | AWG 28/19 |
| | | Type of conductor and conductor cross-section | AWG 16/1 |
| | | Type of conductor and conductor cross-section | AWG 16/19 |
| Evaluation | passed | | |
| Test for damage to and accidental loosening of conductors | Standard | DIN EN 60999-1 section 9.4 / 12.00 | |
| | Requirement | 0.2 kg | |
| | Conductor type | Type of conductor and conductor cross-section | stranded 0.25 mm ² |
| | | Type of conductor and conductor cross-section | AWG 28/1 |
| | | Type of conductor and conductor cross-section | AWG 28/19 |
| | Evaluation | passed | |
| | Requirement | 0.3 kg | |
| | Conductor type | Type of conductor and conductor cross-section | solid 0.5 mm ² |
| | Evaluation | passed | |
| | Requirement | 0.4 kg | |
| Conductor type | Type of conductor and conductor cross-section | solid 1.5 mm ² | |
| | Type of conductor and conductor cross-section | stranded 1.5 mm ² | |
| | Type of conductor and conductor cross-section | AWG 16/1 | |
| | Type of conductor and conductor cross-section | AWG 16/19 | |
| Evaluation | passed | | |

**OMNIMATE Signal - series BC/SC 3.81
BCZ 3.81/16/270 SN BK BX**

Weidmüller Interface GmbH & Co. KG
Klingenbergstraße 26
D-32758 Detmold
Germany
Fon: +49 5231 14-0
Fax: +49 5231 14-292083
www.weidmueller.com

Technical data

| | | | | |
|---------------|----------------|---|-------------------------------|--|
| Pull-out test | Standard | DIN EN 60999-1 section 9.5 / 12.00 | | |
| | Requirement | ≥10 N | | |
| | Conductor type | Type of conductor and conductor cross-section | stranded 0.25 mm ² | |
| | | Type of conductor and conductor cross-section | AWG 28/1 | |
| | | Type of conductor and conductor cross-section | AWG 28/19 | |
| | Evaluation | passed | | |
| | Requirement | ≥20 N | | |
| | Conductor type | Type of conductor and conductor cross-section | H05V-U0.5 | |
| | | Evaluation | passed | |
| | Requirement | ≥40 N | | |
| | Conductor type | Type of conductor and conductor cross-section | H07V-U1.5 | |
| | | Type of conductor and conductor cross-section | H07V-K1.5 | |
| | | Type of conductor and conductor cross-section | AWG 16/1 | |
| | | Type of conductor and conductor cross-section | AWG 16/19 | |
| | Evaluation | passed | | |

Classifications

| | | | |
|-------------|-------------|------------|-------------|
| ETIM 6.0 | EC002638 | ETIM 7.0 | EC002638 |
| eClass 9.0 | 27-44-03-09 | eClass 9.1 | 27-44-03-09 |
| eClass 10.0 | 27-44-03-09 | UNSPSC | 30-21-18-10 |

Notes

| | |
|----------------|--|
| Notes | <ul style="list-style-type: none"> • Additional colours on request • Rated current related to rated cross-section & min. No. of poles. • Wire end ferrule without plastic collar to DIN 46228/1 • Wire end ferrule with plastic collar to DIN 46228/4 • P on drawing = pitch • Rated data refer only to the component itself. Clearance and creepage distances to other components are to be designed in accordance with the relevant application standards. • Long term storage of the product with average temperature of 50 °C and average humidity 70%, 36 months |
| IPC conformity | Conformity: The products are developed, manufactured and delivered according international recognized standards and norms and comply with the assured properties in the data sheet resp. fulfill decorative properties in accordance with IPC-A-610 "Class 2". Further claims on the products can be evaluated on request. |

Data sheet**OMNIMATE Signal - series BC/SC 3.81
BCZ 3.81/16/270 SN BK BX**

Weidmüller Interface GmbH & Co. KG
Klingenbergstraße 26
D-32758 Detmold
Germany
Fon: +49 5231 14-0
Fax: +49 5231 14-292083
www.weidmueller.com

Technical data**Approvals**

Approvals



ROHS

Conform

DownloadsApproval/Certificate/Document of
Conformity[Declaration of the Manufacturer](#)

Brochure/Catalogue

[FL DRIVES EN](#)
[MB DEVICE MANUF. EN](#)
[FL DRIVES DE](#)
[CAT 2 PORTFOLIOGUIDE EN](#)
[FL BUILDING SAFETY EN](#)
[FL APPL LED LIGHTING EN](#)
[FL INDUSTR.CONTROLS EN](#)
[FL MACHINE SAFETY EN](#)
[FL HEATING ELECTR EN](#)
[FL APPL INVERTER EN](#)
[FL_BASE_STATION_EN](#)
[FL ELEVATOR EN](#)
[FL POWER SUPPLY EN](#)
[FL 72H SAMPLE SER EN](#)
[PO OMNIMATE EN](#)

Engineering Data

[EPLAN_WSCAD](#)

Engineering Data

[STEP](#)

**OMNIMATE Signal - series BC/SC 3.81
BCZ 3.81/16/270 SN BK BX**

Weidmüller Interface GmbH & Co. KG
Klingenbergstraße 26
D-32758 Detmold
Germany
Fon: +49 5231 14-0
Fax: +49 5231 14-292083
www.weidmueller.com

Drawings

Dimensional drawing

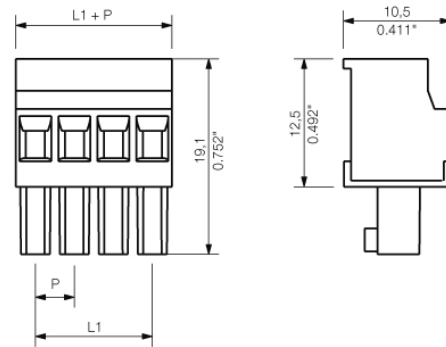

Graph

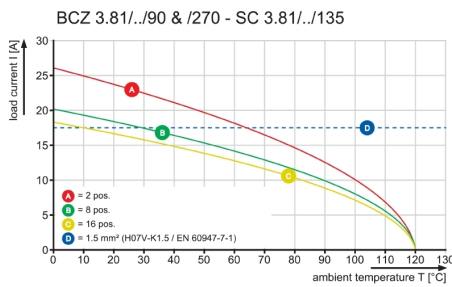

Graph

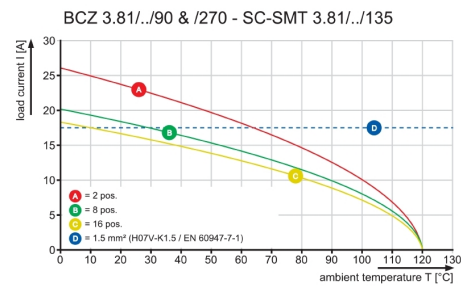

Graph

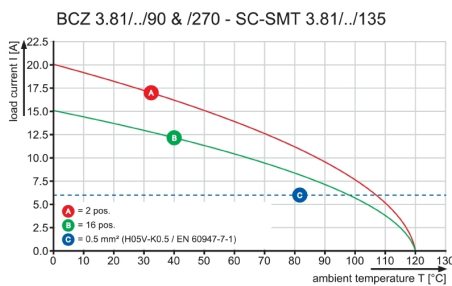

Graph

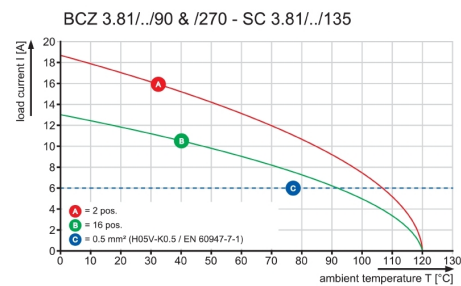

BCZ 3.81/.../270 ...

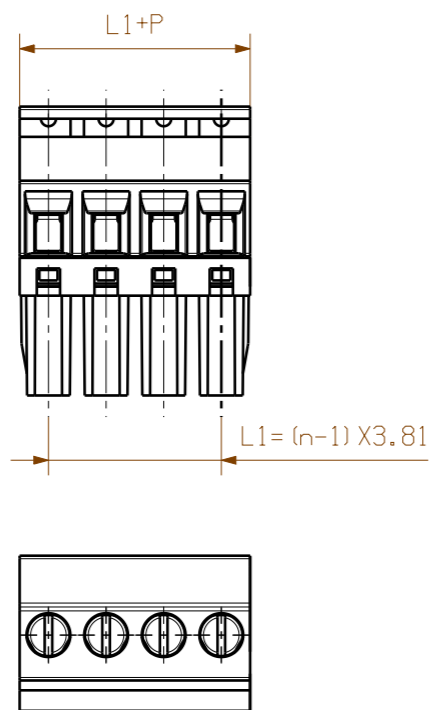

BCZ 3.81/.../270F ...



NOTE:

n=NO OF POLES
P=PITCH

KUNDENZEICHUNG
CUSTOMER DRAWING

| | | |
|----|---------|-----------|
| 16 | 57.15 | 2.250 |
| 15 | 53.34 | 2.100 |
| 14 | 49.53 | 1.950 |
| 13 | 45.72 | 1.800 |
| 12 | 41.91 | 1.650 |
| 11 | 38.10 | 1.500 |
| 10 | 34.29 | 1.350 |
| 9 | 30.48 | 1.200 |
| 8 | 26.67 | 1.050 |
| 7 | 22.86 | 0.900 |
| 6 | 19.05 | 0.750 |
| 5 | 15.24 | 0.600 |
| 4 | 11.43 | 0.450 |
| 3 | 7.62 | 0.300 |
| 2 | 3.81 | 0.150 |
| n | L1 [mm] | L1 [inch] |

For the mounting of PCBs, it should be noted that the rated data given in the catalogue relates only to the connection elements. The necessary creepage and clearance paths must be observed in connection with the respective applicant in accordance to VDE 0110. The current-carrying capacity and pitch tolerance is to be determined according to DIN IEC 326 part 3 very fine.

Weidmüller connectors are tested to the DIN VDE 0627 standard, and are valid for its field of application. Provided that the connectors are used to the intended purpose, all requirements with respect to the occurring of electrical, mechanical, thermic and corrosive stress will be satisfied.

| | | | | | |
|------------------------------|--|---------------|--|-----------------------|--|
| | | CAT.NO.: | | C 40382 04 | |
| 62605/5 17.08.12 SHI_S 01 | | MODIFICATION | | DRAWING NO. ISSUE NO. | |
| Weidmüller | | DATE | | NAME | |
| DRAWN | | 06.04.2006 | | GU_D | |
| RESPONSIBLE | | 27.08.2012 | | XU_S | |
| CHECKED | | 27.08.2012 | | ZHOU_N | |
| APPROVED | | | | XU_S | |
| SCALE: 2/1 | | SUPERSEDES: - | | SUPERSEDED BY: . | |
| BCZ 3.81/.../270 ... | | BUCHSENLEISTE | | SOCKET BLOCK | |
| PRODUCT FILE: BCZ 3.81 | | 7070 | | | |

WEITERGABE SOWIE VERVIELFÄLTIGUNG DIESES DOKUMENTS, VERWERTUNG UND MITTEILUNG SEINES INHALTS SIND VERBOTEN, SOWEIT NICHT AUSDRUECKLICH GESTATET.
 ZUWIDERHANDLUNGEN VERPFLICHTEN ZU SCHADENERSATZ. ALLE RECHTE FUER DEN FALL DER PATENT-, GEBRAUCHSMUSTER- ODER GESCHMACKSMUSTEREINTRAGUNG VORBEHALTEN.
 THE REPRODUCTION, DISTRIBUTION AND UTILIZATION OF THIS DOCUMENT AS WELL AS THE COMMUNICATION OF ITS CONTENTS TO OTHERS WITHOUT EXPLICIT AUTHORIZATION IS PROHIBITED.
 OFFENDERS WILL BE HELD LIABLE FOR THE PAYMENT OF DAMAGES. ALL RIGHTS RESERVED IN THE EVENT OF THE GRANT OF A PATENT, UTILITY MODEL OR DESIGN.

