

**OMNIMATE Signal - series BL/SL 5.08
SL-SMT 5.08HC/06/270FL 3.2SN BK BX**

Weidmüller Interface GmbH & Co. KG
Klingenbergstraße 16
D-32758 Detmold
Germany
Fon: +49 5231 1429-0
Fax: +49 5231 14292083
www.weidmueller.com

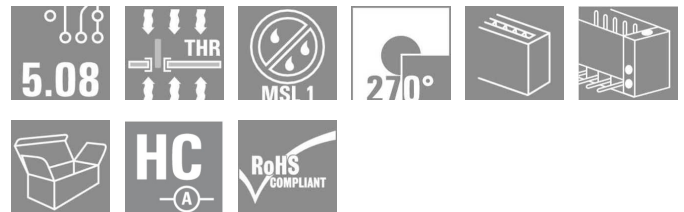

High-temperature-resistant, straight, open pin header.
Packed in box or tape. On tape and with 1.5 mm solder pin, optimised for automatic assembly. 3.2 mm solder pin suitable for reflow and wave soldering. The pin headers provide space for labelling and can be coded. HC = High Current.

General ordering data

Available until	2010-05-31
Type	SL-SMT 5.08HC/06/270FL 3.2SN BK BX
Order No.	1876890000
Version	PCB plug-in connector, male header, Solder flange, THT/THR solder connection, 5.08 mm, No. of poles: 6, 270°, Solder pin length (l): 3.2 mm, tinned, Black, Box
GTIN (EAN)	4032248467471
Qty.	50 pc(s).
Product data	IEC: 400 V / 27.5 A UL: 300 V / 18.5 A
Packaging	Box

**OMNIMATE Signal - series BL/SL 5.08
SL-SMT 5.08HC/06/270FL 3.2SN BK BX**

Weidmüller Interface GmbH & Co. KG
 Klängenbergstraße 16
 D-32758 Detmold
 Germany
 Fon: +49 5231 1429-0
 Fax: +49 5231 14292083
 www.weidmueller.com

Technical data**Dimensions and weights**

Net weight 3.662 g

System specifications

Product family	OMNIMATE Signal - series BL/SL 5.08	Mounting onto the PCB	THT/THR solder connection
Pitch in mm (P)	5.08 mm	Pitch in inches (P)	0.2 inch
Outgoing elbow	270°	No. of poles	6
Number of solder pins per pole	1	Solder pin length (l)	3.2 mm
Solder pin length tolerance	0 / -0.3 mm	Tolerance of solder pin position	± 0.1 mm
Solder pin dimensions	d = 1.2 mm, Octagonal	Solder eyelet hole diameter (D)	1.4 mm
Solder eyelet hole diameter tolerance (D)	+ 0,1 mm	L1 in mm	25.4 mm
L1 in inches	1 inch	Number of rows	1
Pin series quantity	1	Can be coded	Yes
Plugging cycles	25	Packaging	Box

Material data

Insulating material	LCP GF	Colour	Black
Colour chart (similar)	RAL 9011	Insulating material group	IIIa
CTI	≥ 175	Insulation resistance	≥ 10 ⁸ Ω
Moisture Level (MSL)	1	UL 94 flammability rating	V-0
Contact material	CuSn	Contact surface	tinned
Layer structure of solder connection	1-3 µm Ni / 2-4 µm Sn matt	Layer structure of plug contact	1-3 µm Ni / 2-4 µm Sn matt
Storage temperature, min.	-25 °C	Storage temperature, max.	55 °C
Max. relative humidity during storage	80 %	Operating temperature, min.	-50 °C
Operating temperature, max.	100 °C	Temperature range, installation, min.	-30 °C
Temperature range, installation, max.	100 °C		

Rated data acc. to IEC

tested acc. to standard	IEC 60664-1, IEC 61984	Rated current, min. no. of poles (Ta = 20°C)	27.5 A
Rated current, max. no. of poles (Ta = 20°C)	19 A	Rated current, min. no. of poles (Ta = 40°C)	24 A
Rated current, max. no. of poles (Ta = 40°C)	16.5 A	Rated voltage for surge voltage class / pollution degree II/2	400 V
Rated voltage for surge voltage class / pollution degree III/2	320 V	Rated voltage for surge voltage class / pollution degree III/3	250 V
Rated impulse voltage for surge voltage class/ pollution degree II/2	4 kV	Rated impulse voltage for surge voltage class/ pollution degree III/2	4 kV
Rated impulse voltage for surge voltage class/ contamination degree III/3	4 kV		

Rated data acc. to CSA

Institute (CSA)		Certificate No. (CSA)	200039-1176845
Rated voltage (Use group B)	300 V	Rated voltage (use group D)	300 V
Rated current (use group B)	18.5 A	Rated current (use group D)	18.5 A
Reference to approval values	Specifications are maximum values, details - see approval certificate.		

Creation date October 13, 2016 11:57:31 AM CEST

**OMNIMATE Signal - series BL/SL 5.08
SL-SMT 5.08HC/06/270FL 3.2SN BK BX**

Weidmüller Interface GmbH & Co. KG
 Klingenbergstraße 16
 D-32758 Detmold
 Germany
 Fon: +49 5231 1429-0
 Fax: +49 5231 14292083
 www.weidmueller.com

Technical data**Rated data acc. to UL 1059**

Institute (UR)		Certificate No. (UR)	E60693
Rated voltage (use group B)	300 V	Rated voltage (use group D)	300 V
Rated current (use group B)	18.5 A	Rated current (use group D)	10 A
Reference to approval values	Specifications are maximum values, details - see approval certificate.		

Classifications

ETIM 3.0	EC001284	ETIM 4.0	EC002637
ETIM 5.0	EC002637	ETIM 6.0	EC002637
UNSPSC	30-21-18-10	eClass 5.1	27-26-07-04
eClass 6.2	27-26-07-04	eClass 7.1	27-44-04-02
eClass 8.1	27-44-04-02	eClass 9.0	27-44-04-02

Notes

Notes	<ul style="list-style-type: none"> • Gold-plated contact surfaces on request • Rated current related to rated cross-section & min. No. of poles. • P on drawing = pitch • Rated data refer only to the component itself. Clearance and creepage distances to other components are to be designed in accordance with the relevant application standards.
IPC conformity	The products are developed, manufactured and delivered according to the internationally recognised IPC-A-610 standard, category "permissible". More extensive demands on the products can be evaluated on request.

Approvals

Approvals	
ROHS	Conform

Downloads

EDA Layout Library (Mentor Graphics Expedition, Mentor Graphics Pads, Altium Designer)	Select your download
SMT white paper	Download Whitepaper
Safety notice	Safety indication

Data sheet

**OMNIMATE Signal - series BL/SL 5.08
SL-SMT 5.08HC/06/270FL 3.2SN BK BX**

Weidmüller Interface GmbH & Co. KG
 Klingenbergstraße 16
 D-32758 Detmold
 Germany
 Fon: +49 5231 1429-0
 Fax: +49 5231 14292083
 www.weidmueller.com

Drawings

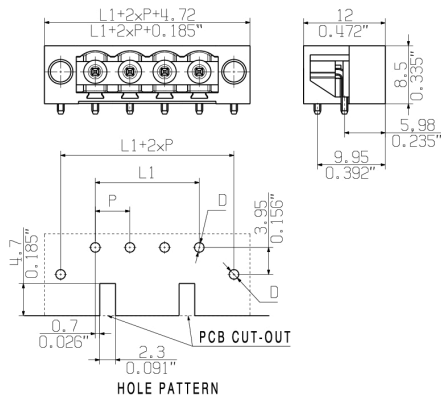

**OMNIMATE Signal - series BL/SL 5.08
SL-SMT 5.08HC/06/270FL 3.2SN BK BX**

Weidmüller Interface GmbH & Co. KG
Klingenbergstraße 16
D-32758 Detmold
Germany
Fon: +49 5231 1429-0
Fax: +49 5231 14292083
www.weidmueller.com

Mating connector (fully pluggable)
BLF 5.08HC/90F SN

Just as reliable as the millionfold proven original and featuring innovative details:
The BLF 5.08HC PUSH IN version of the BLZP 5.08HC female connector is not only different in terms of connection system; it also has a more compact design. Weidmüller's innovative PUSH IN spring connection system stands for the future of easy and tool-free wire connection. HC = High Current.
In terms of versatility, the BLF 5.08HC offers just as much as the version which served as a model:

- 3 tested-and-proven wire outlet directions provide the usual flexibility for application-specific design
- 4 flange variations and the patented release latch allow the locking concept to be based on the requirements of the user
- Use the BLF 5.08HC and SL 5.08HC plug combination to reach the max. rated specifications

General ordering data

Type	Order No.	Version	GTIN (EAN)	Qty.	Product data	Packaging
BLF 5.08HC/06/90F SN BK BX	1000260001	PCB plug-in connector, female plug, 5.08 mm, No. of poles: 6, 90°, PUSH IN, Clamping range, rated connection, max.: 3.31 mm ² , Box	4032248690220 42	pc(s).	IEC: 400 V / 24 A / 0.2 - 2.5 mm ² UL: 300 V / 18.5 A / AWG 26 - AWG 12	Box
BLF 5.08HC/06/90F SN OR BX	1002130000	PCB plug-in connector, female plug, 5.08 mm, No. of poles: 6, 90°, PUSH IN, Clamping range, rated connection, max.: 3.31 mm ² , Box	4032248694082 42	pc(s).	IEC: 400 V / 24 A / 0.2 - 2.5 mm ² UL: 300 V / 18.5 A / AWG 26 - AWG 12	Box

BLZP 5.08HC/180LR SN

Female plug with clamping-yoke screw system for connecting wires with straight (180°) outlet direction. The female connectors provide space for labelling and can be coded. Fastened by means of a flange or release latch. They also provide an integrated plus/minus screw, protection against faulty insertion of the wire, and they are delivered with open clamping yokes. HC = High Current.

General ordering data

Type	Order No.	Version	GTIN (EAN)	Qty.	Product data	Packaging
BLZP 5.08HC/06/180LR SN BK BX	1945100000	PCB plug-in connector, female plug, 5.08 mm, No. of poles: 6, 180°, Clamping yoke connection, Clamping	4032248620241 42	pc(s).	IEC: 400 V / 23 A / 0.2 - 4 mm ² UL: 300 V / 20 A / AWG 30 - AWG 12	Box

**OMNIMATE Signal - series BL/SL 5.08
SL-SMT 5.08HC/06/270FL 3.2SN BK BX**

Weidmüller Interface GmbH & Co. KG
Klingenbergstraße 16
D-32758 Detmold
Germany
Fon: +49 5231 1429-0
Fax: +49 5231 14292083
www.weidmueller.com

Mating connector (fully pluggable)

		range, rated connection, max.: 4 mm ² , Box		
BLZP	1944870000	PCB plug-in connector, female plug, 5.08 mm, No. of poles: 6, 180°, Clamping yoke connection, Clamping range, rated connection, max.: 4 mm ² , Box	403224861948142 pc(s).	IEC: 400 V / 23 A / 0.2 - 4 mm ² Box UL: 300 V / 20 A / AWG 30 - AWG 12
5.08HC/06/180LR				
SN OR BX				

BLF 5.08HC/180F SN

Just as reliable as the millionfold proven original and featuring innovative details:
The BLF 5.08HC PUSH IN version of the BLZP 5.08HC female connector is not only different in terms of connection system; it also has a more compact design. Weidmüller's innovative PUSH IN spring connection system stands for the future of easy and tool-free wire connection. HC = High Current.
In terms of versatility, the BLF 5.08HC offers just as much as the version which served as a model:

- 3 tested-and-proven wire outlet directions provide the usual flexibility for application-specific design
- 4 flange variations and the patented release latch allow the locking concept to be based on the requirements of the user
- Use the BLF 5.08HC and SL 5.08HC plug combination to reach the max. rated specifications

General ordering data

Type	Order No.	Version	GTIN (EAN)	Qty.	Product data	Packaging
BLF	1012680000	PCB plug-in connector, female plug, 5.08 mm, No. of poles: 6, 180°, PUSH IN, Clamping range, rated connection, max.: 3.31 mm ² , Box	403224872033042 pc(s).		IEC: 400 V / 24 A / 0.2 - 2.5 mm ² UL: 300 V / 18.5 A / AWG 26 - AWG 12	Box
5.08HC/06/180F						
SN BK BX						
BLF	1013130000	PCB plug-in connector, female plug, 5.08 mm, No. of poles: 6, 180°, PUSH IN, Clamping range, rated connection, max.: 3.31 mm ² , Box	403224872088042 pc(s).		IEC: 400 V / 24 A / 0.2 - 2.5 mm ² UL: 300 V / 18.5 A / AWG 26 - AWG 12	Box
5.08HC/06/180F						
SN OR BX						

**OMNIMATE Signal - series BL/SL 5.08
SL-SMT 5.08HC/06/270FL 3.2SN BK BX**

Weidmüller Interface GmbH & Co. KG
Klingenbergstraße 16
D-32758 Detmold
Germany
Fon: +49 5231 1429-0
Fax: +49 5231 14292083
www.weidmueller.com

Mating connector (fully pluggable)
BLZP 5.08HC/90F SN

Female plugs with clamping-yoke connection for connecting wires with a right-angle (90° or 270°) outlet direction. The female connectors provide space for labelling and can be coded. Fastened by means of a flange or release latch. They also provide an integrated plus/minus screw, protection against faulty insertion of the wire, and they are delivered with open clamping yokes. HC = High Current.

General ordering data

Type	Order No.	Version	GTIN (EAN)	Qty.	Product data	Packaging
BLZP 5.08HC/06/90F SN OR BX	1949840000	PCB plug-in connector, female plug, 5.08 mm, No. of poles: 6, 90°, Clamping yoke connection, Clamping range, rated connection, max.: 4 mm ² , Box	4032248627769 42 pc(s).		IEC: 400 V / 23 A / 0.2 - 4 mm ² UL: 300 V / 20 A / AWG 30 - AWG 12	Box
BLZP 5.08HC/06/90F SN BK BX	1950080000	PCB plug-in connector, female plug, 5.08 mm, No. of poles: 6, 90°, Clamping yoke connection, Clamping range, rated connection, max.: 4 mm ² , Box	4032248628018 42 pc(s).		IEC: 400 V / 23 A / 0.2 - 4 mm ² UL: 300 V / 20 A / AWG 30 - AWG 12	Box

BLZP 5.08HC/270LR SN

Female plugs with clamping-yoke connection for connecting wires with a right-angle (90° or 270°) outlet direction. The female connectors provide space for labelling and can be coded. Fastened by means of a flange or release latch. They also provide an integrated plus/minus screw, protection against faulty insertion of the wire, and they are delivered with open clamping yokes. HC = High Current.

General ordering data

Delivery status Available until	Type	Order No.	Version	GTIN (EAN)	Qty.
Discontinued 2016-04-08T00:00:00+02:00	BLZP 5.08HC/06/270LR SN BK BX	1947800000	PCB plug-in connector, female plug, 5.08 mm, No. of poles: 6, 270°, Clamping yoke connection, Clamping range, rated connection, max.: 4 mm ² , Box	4032248624195	42 pc(s).
BLZP 5.08HC/06/270LR SN OR BX	PCB plug-in connector, female plug, 5.08 mm, No. of poles: 6, 270°, Clamping	1947570000	4032248623860 42 pc(s).	IEC: 400 V / 23 A / 0.2 - 4 mm ² UL: 300 V / 20 A / AWG 30 - AWG 12	Box

Creation date October 13, 2016 11:57:31 AM CEST

**OMNIMATE Signal - series BL/SL 5.08
SL-SMT 5.08HC/06/270FL 3.2SN BK BX**

Weidmüller Interface GmbH & Co. KG
Klingenbergstraße 16
D-32758 Detmold
Germany
Fon: +49 5231 1429-0
Fax: +49 5231 14292083
www.weidmueller.com

Mating connector (fully pluggable)

yoke connection, Clamping
range, rated connection,
max.: 4 mm², Box

BLF 5.08HC/180LR SN

Just as reliable as the millionfold proven original and featuring innovative details:
The BLF 5.08HC PUSH IN version of the BLZP 5.08HC female connector is not only different in terms of connection system; it also has a more compact design. Weidmüller's innovative PUSH IN spring connection system stands for the future of easy and tool-free wire connection. HC = High Current.
In terms of versatility, the BLF 5.08HC offers just as much as the version which served as a model:

- 3 tested-and-proven wire outlet directions provide the usual flexibility for application-specific design
- 4 flange variations and the patented release latch allow the locking concept to be based on the requirements of the user
- Use the BLF 5.08HC and SL 5.08HC plug combination to reach the max. rated specifications

General ordering data

Type	Order No.	Version	GTIN (EAN)	Qty.	Product data	Packaging
BLF 5.08HC/06/180LR SN OR BX	1014420000	PCB plug-in connector, female plug, 5.08 mm, No. of poles: 6, 180°, PUSH IN, Clamping range, rated connection, max.: 3.31 mm ² , Box	4032248722945	42 pc(s).	IEC: 400 V / 24 A / 0.2 - 2.5 mm ² UL: 300 V / 18.5 A / AWG 26 - AWG 12	Box
BLF 5.08HC/06/180LR SN BK BX	1014160000	PCB plug-in connector, female plug, 5.08 mm, No. of poles: 6, 180°, PUSH IN, Clamping range, rated connection, max.: 3.31 mm ² , Box	4032248723171	42 pc(s).	IEC: 400 V / 24 A / 0.2 - 2.5 mm ² UL: 300 V / 18.5 A / AWG 26 - AWG 12	Box

**OMNIMATE Signal - series BL/SL 5.08
SL-SMT 5.08HC/06/270FL 3.2SN BK BX**

Weidmüller Interface GmbH & Co. KG
Klingenbergstraße 16
D-32758 Detmold
Germany
Fon: +49 5231 1429-0
Fax: +49 5231 14292083
www.weidmueller.com

Mating connector (fully pluggable)
BLZP 5.08HC/180F SN

Female plug with clamping-yoke screw system for connecting wires with straight (180°) outlet direction. The female connectors provide space for labelling and can be coded. Fastened by means of a flange or release latch. They also provide an integrated plus/minus screw, protection against faulty insertion of the wire, and they are delivered with open clamping yokes. HC = High Current.

General ordering data

Type	Order No.	Version	GTIN (EAN)	Qty.	Product data	Packaging
BLZP 5.08HC/06/180F SN OR BX	1944130000	PCB plug-in connector, female plug, 5.08 mm, No. of poles: 6, 180°, Clamping yoke connection, Clamping range, rated connection, max.: 4 mm ² , Box	4032248618712 42 pc(s).		IEC: 400 V / 23 A / 0.2 - 4 mm ² UL: 300 V / 20 A / AWG 30 - AWG 12	Box
BLZP 5.08HC/06/180F SN BK BX	1944370000	PCB plug-in connector, female plug, 5.08 mm, No. of poles: 6, 180°, Clamping yoke connection, Clamping range, rated connection, max.: 4 mm ² , Box	4032248618941 42 pc(s).		IEC: 400 V / 23 A / 0.2 - 4 mm ² UL: 300 V / 20 A / AWG 30 - AWG 12	Box

BLF 5.08HC/270F SN

Just as reliable as the millionfold proven original and featuring innovative details:
The BLF 5.08HC PUSH IN version of the BLZP 5.08HC female connector is not only different in terms of connection system; it also has a more compact design. Weidmüller's innovative PUSH IN spring connection system stands for the future of easy and tool-free wire connection. HC = High Current.
In terms of versatility, the BLF 5.08HC offers just as much as the version which served as a model:

- 3 tested-and-proven wire outlet directions provide the usual flexibility for application-specific design
- 4 flange variations and the patented release latch allow the locking concept to be based on the requirements of the user
- Use the BLF 5.08HC and SL 5.08HC plug combination to reach the max. rated specifications

General ordering data

Delivery status	Available until	Type	Order No.	Version	GTIN (EAN)	Qty.
Discontinued	2016-04-08T00:00:00+02:00	BLF 5.08HC/06/270F SN BK BX	1982160000	PCB plug-in connector, female plug, 5.08 mm, No. of poles: 6, 270°, PUSH IN,	4032248686254	42 pc(s).

**OMNIMATE Signal - series BL/SL 5.08
SL-SMT 5.08HC/06/270FL 3.2SN BK BX**

Weidmüller Interface GmbH & Co. KG
Klingenbergstraße 16
D-32758 Detmold
Germany
Fon: +49 5231 1429-0
Fax: +49 5231 14292083
www.weidmueller.com

Mating connector (fully pluggable)

Clamping range,
rated connection,
max.: 3.31 mm²,
Box

BLF 5.08HC/06/270F SN OR BX	1982930000 PCB plug-in connector, female plug, 5.08 mm, No. of poles: 6, 270°, PUSH IN, Clamping range, rated connection, max.: 3.31 mm ² , Box	4032248687022 42 pc(s).	IEC: 400 V / 24 A / 0.2 - 2.5 mm ² UL: 300 V / 18.5 A / AWG 26 - AWG 12	Box
-----------------------------------	--	-------------------------	--	-----

BLF 5.08HC/270LR SN

Just as reliable as the millionfold proven original and featuring innovative details:
The BLF 5.08HC PUSH IN version of the BLZP 5.08HC female connector is not only different in terms of connection system; it also has a more compact design. Weidmüller's innovative PUSH IN spring connection system stands for the future of easy and tool-free wire connection. HC = High Current.
In terms of versatility, the BLF 5.08HC offers just as much as the version which served as a model:

- 3 tested-and-proven wire outlet directions provide the usual flexibility for application-specific design
- 4 flange variations and the patented release latch allow the locking concept to be based on the requirements of the user
- Use the BLF 5.08HC and SL 5.08HC plug combination to reach the max. rated specifications

General ordering data

Delivery status	Available until	Type	Order No.	Version	GTIN (EAN)	Qty.
Discontinued	2016-04-08T00:00:00+02:00	BLF 5.08HC/06/270LR SN BK BX	1982350000	PCB plug-in connector, female plug, 5.08 mm, No. of poles: 6, 270°, PUSH IN, Clamping range, rated connection, max.: 3.31 mm ² , Box	4032248686445	42 pc(s).
BLF	1983120000	PCB plug-in connector, female plug, 5.08 mm, No. of poles: 6, 270°, PUSH IN, Clamping range, rated connection, max.: 3.31 mm ² , Box	4032248687213 42 pc(s).	IEC: 400 V / 24 A / 0.2 - 2.5 mm ² UL: 300 V / 18.5 A / AWG 26 - AWG 12	Box	

**OMNIMATE Signal - series BL/SL 5.08
SL-SMT 5.08HC/06/270FL 3.2SN BK BX**

Weidmüller Interface GmbH & Co. KG
Klingenbergstraße 16
D-32758 Detmold
Germany
Fon: +49 5231 1429-0
Fax: +49 5231 14292083
www.weidmueller.com

Mating connector (fully pluggable)
BLF 5.08HC/90LR SN

Just as reliable as the millionfold proven original and featuring innovative details:
The BLF 5.08HC PUSH IN version of the BLZP 5.08HC female connector is not only different in terms of connection system; it also has a more compact design. Weidmüller's innovative PUSH IN spring connection system stands for the future of easy and tool-free wire connection. HC = High Current.
In terms of versatility, the BLF 5.08HC offers just as much as the version which served as a model:

- 3 tested-and-proven wire outlet directions provide the usual flexibility for application-specific design
- 4 flange variations and the patented release latch allow the locking concept to be based on the requirements of the user
- Use the BLF 5.08HC and SL 5.08HC plug combination to reach the max. rated specifications

General ordering data

Type	Order No.	Version	GTIN (EAN)	Qty.	Product data	Packaging
BLF 5.08HC/06/90LR SN BK BX	1000450001	PCB plug-in connector, female plug, 5.08 mm, No. of poles: 6, 90°, PUSH IN, Clamping range, rated connection, max.: 3.31 mm ² , Box	4032248690411	42 pc(s).	IEC: 400 V / 24 A / 0.2 - 2.5 mm ² UL: 300 V / 18.5 A / AWG 26 - AWG 12	Box
BLF 5.08HC/06/90LR SN OR BX	1002320000	PCB plug-in connector, female plug, 5.08 mm, No. of poles: 6, 90°, PUSH IN, Clamping range, rated connection, max.: 3.31 mm ² , Box	4032248694488	42 pc(s).	IEC: 400 V / 24 A / 0.2 - 2.5 mm ² UL: 300 V / 18.5 A / AWG 26 - AWG 12	Box

BLZP 5.08HC/270F SN

Female plugs with clamping-yoke connection for connecting wires with a right-angle (90° or 270°) outlet direction. The female connectors provide space for labelling and can be coded. Fastened by means of a flange or release latch. They also provide an integrated plus/minus screw, protection against faulty insertion of the wire, and they are delivered with open clamping yokes. HC = High Current.

General ordering data

Type	Order No.	Version	GTIN (EAN)	Qty.	Product data	Packaging
BLZP 5.08HC/06/270F SN BK BX	1950620000	PCB plug-in connector, female plug, 5.08 mm, No. of poles: 6, 270°, Clamping yoke connection, Clamping	4032248628896	42 pc(s).	IEC: 400 V / 23 A / 0.2 - 4 mm ² UL: 300 V / 20 A / AWG 30 - AWG 12	Box

**OMNIMATE Signal - series BL/SL 5.08
SL-SMT 5.08HC/06/270FL 3.2SN BK BX**

Weidmüller Interface GmbH & Co. KG
Klingenbergstraße 16
D-32758 Detmold
Germany
Fon: +49 5231 1429-0
Fax: +49 5231 14292083
www.weidmueller.com

Mating connector (fully pluggable)

		range, rated connection, max.: 4 mm ² , Box			
BLZP	1950350000	PCB plug-in connector, female plug, 5.08 mm, No. of poles: 6, 270°, Clamping yoke connection, Clamping range, rated connection, max.: 4 mm ² , Box	4032248628476 42 pc(s).	IEC: 400 V / 23 A / 0.2 - 4 mm ² UL: 300 V / 20 A / AWG 30 - AWG 12	Box
5.08HC/06/270F SN OR BX					

BLDF 5.08/180LR SN

The powerful daisy-chain solution for high-performance signal bus applications is also suitable for 400V auxiliary power chains with 18.5 A current-carrying capacity. The large clamping capacity (up to 2.5mm² wire cross-sections) is particularly beneficial for long bus cables or high currents because of the low voltage drop. Four flange variations, including the patented release latch, so you can design the interlock based on the requirements of the user.

General ordering data

Type	Order No.	Version	GTIN (EAN)	Qty.	Product data	Packaging
BLDF	1001050000	PCB plug-in connector, female plug, 5.08 mm, No. of poles: 6, 180°, PUSH IN, Clamping range, rated connection, max.: 3.31 mm ² , Box	4032248817597 28 pc(s).		IEC: 400 V / 20.8 A / 0.2 - 2.5 mm ² UL: 300 V / 10 A / AWG 12 - AWG 26	Box
5.08/06/180LR SN BK BX						
BLDF	1065170000	PCB plug-in connector, female plug, 5.08 mm, No. of poles: 6, 180°, PUSH IN, Clamping range, rated connection, max.: 3.31 mm ² , Box	4032248817405 28 pc(s).		IEC: 400 V / 20.8 A / 0.2 - 2.5 mm ² UL: 300 V / 10 A / AWG 12 - AWG 26	Box
5.08/06/180LR SN OR BX						

BLT 5.08HC/180LR

Female plugs with TOP screw connection system for connecting wires with straight wire outlet and release latch mechanism. The female connectors provide space for labelling and can be coded. HC = High Current.

General ordering data

Type	Order No.	Version	GTIN (EAN)	Qty.	Product data	Packaging
BLT	1890260000	PCB plug-in connector, female plug, 5.08 mm, No. of poles: 6, 180°, TOP	4032248498741 42 pc(s).		IEC: 400 V / 27 A / 0.2 - 2.5 mm ² UL: 300 V / 17 A / AWG 26 - AWG 14	Box
5.08HC/06/180LR SN OR BX						

Creation date October 13, 2016 11:57:31 AM CEST

**OMNIMATE Signal - series BL/SL 5.08
SL-SMT 5.08HC/06/270FL 3.2SN BK BX**

Weidmüller Interface GmbH & Co. KG
Klingenbergstraße 16
D-32758 Detmold
Germany
Fon: +49 5231 1429-0
Fax: +49 5231 14292083
www.weidmueller.com

Mating connector (fully pluggable)

connection, Clamping
range, rated connection,
max.: 2.5 mm², Box

Discontinued	2016-04-08T00:00:00+02:00	BLT 5.08HC/06/180LR SN 1894170000 BK BX	PCB plug-in connector, female plug, 5.08 mm, No. of poles: 6, 180°, TOP connection, Clamping range, rated connection, max.: 2.5 mm ² , Box	4032248508518	42 pc(s).
--------------	---------------------------	--	--	---------------	--------------

BLL 5.08/90FI



Female header for PCB mounting. The solder pin length is optimised for wave flow soldering.

General ordering data

Type	Order No.	Version	GTIN (EAN)	Qty.	Product data	Packaging
BLL 5.08/06/90FI 3.2SN OR BX	1843790000	PCB plug-in connector, female header, Inverted flange, THT solder connection, 5.08 mm, No. of poles: 6, 90°, Solder pin length (l): 3.2 mm, tinned, Orange, Box	4032248355549	42 pc(s).	IEC: 400 V / 23 A UL: 300 V / 15 A	Box

BLZP 5.08HC/90LR



Female plugs with clamping-yoke connection for connecting wires with a right-angle (90° or 270°) outlet direction. The female connectors provide space for labelling and can be coded. Fastened by means of a flange or release latch. They also provide an integrated plus/minus screw, protection against faulty insertion of the wire, and they are delivered with open clamping yokes. HC = High Current.

General ordering data

Type	Order No.	Version	GTIN (EAN)	Qty.	Product data	Packaging
BLZP 5.08HC/06/90LR SN OR BX	1087290000	PCB plug-in connector, female plug, 5.08 mm, No. of poles: 6, 90°, Clamping	4032248854080	42 pc(s).	IEC: 400 V / 23 A / 0.2 - 4 mm ² UL: 300 V / 20 A / AWG 30 - AWG 12	Box

**OMNIMATE Signal - series BL/SL 5.08
SL-SMT 5.08HC/06/270FL 3.2SN BK BX**

Weidmüller Interface GmbH & Co. KG
Klingenbergstraße 16
D-32758 Detmold
Germany
Fon: +49 5231 1429-0
Fax: +49 5231 14292083
www.weidmueller.com

Mating connector (fully pluggable)

yoke connection, Clamping
range, rated connection,
max.: 4 mm², Box

Discontinued	2016-04-08T00:00:00+02:00	BLZP 5.08HC/06/90LR SN 1087060000 BK BX	PCB plug-in connector, female plug, 5.08 mm, No. of poles: 6, 90°, Clamping yoke connection, Clamping range, rated connection, max.: 4 mm ² , Box	4032248853731	42 pc(s).
--------------	---------------------------	--	--	---------------	--------------

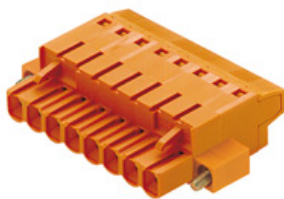
BLT 5.08HC/180F

Female plugs with TOP screw connection system for connecting wires with straight outlet direction and screw flange. The female connectors provide space for labelling and can be coded. HC = High Current.

General ordering data

Type	Order No.	Version	GTIN (EAN)	Qty.	Product data	Packaging
BLT 5.08HC/06/180F SN BK BX	1844260000	PCB plug-in connector, female plug, 5.08 mm, No. of poles: 6, 180°, TOP connection, Clamping range, rated connection, max.: 2.5 mm ² , Box	4032248356195	42 pc(s).	IEC: 400 V / 27 A / 0.2 - 2.5 mm ² UL: 300 V / 17 A / AWG 26 - AWG 14	Box
BLT 5.08HC/06/180F SN OR BX	1844030000	PCB plug-in connector, female plug, 5.08 mm, No. of poles: 6, 180°, TOP connection, Clamping range, rated connection, max.: 2.5 mm ² , Box	4032248355952	42 pc(s).	IEC: 400 V / 27 A / 0.2 - 2.5 mm ² UL: 300 V / 17 A / AWG 26 - AWG 14	Box

**OMNIMATE Signal - series BL/SL 5.08
SL-SMT 5.08HC/06/270FL 3.2SN BK BX**

Weidmüller Interface GmbH & Co. KG
 Klingenbergstraße 16
 D-32758 Detmold
 Germany
 Fon: +49 5231 1429-0
 Fax: +49 5231 14292083
 www.weidmueller.com

Mating connector (fully pluggable)
BLDF 5.08/180F SN

The powerful daisy-chain solution for high-performance signal bus applications is also suitable for 400V auxiliary power chains with 18.5A current-carrying capacity. The large clamping capacity (up to 2.5mm² wire cross-sections) is particularly beneficial for long bus cables or high currents because of the low voltage drop. Four flange variations, including the patented release latch, allow for user-friendly unplugging designs.

General ordering data

Type	Order No.	Version	GTIN (EAN)	Qty.	Product data	Packaging
BLDF 5.08/06/180F SN OR BX	1065090000	PCB plug-in connector, female plug, 5.08 mm, No. of poles: 6, 180°, PUSH IN, Clamping range, rated connection, max.: 3.31 mm ² , Box	4032248817801	28 pc(s).	IEC: 400 V / 20.8 A / 0.2 - 2.5 mm ² UL: 300 V / 10 A / AWG 12 - AWG 26	Box
BLDF 5.08/06/180F SN BK BX	1000980000	PCB plug-in connector, female plug, 5.08 mm, No. of poles: 6, 180°, PUSH IN, Clamping range, rated connection, max.: 3.31 mm ² , Box	4032248817375	28 pc(s).	IEC: 400 V / 20.8 A / 0.2 - 2.5 mm ² UL: 300 V / 10 A / AWG 12 - AWG 26	Box

OMNIMATE Signal - series BL/SL 5.08 SL-SMT 5.08HC/06/270FL 3.2SN BK BX

Weidmüller Interface GmbH & Co. KG
 Klingenbergstraße 16
 D-32758 Detmold
 Germany
 Fon: +49 5231 1429-0
 Fax: +49 5231 14292083
 www.weidmueller.com

Accessories

Coding elements



Only connects what is supposed to be connected: the right connection at the right place.

Coding elements and locking devices clearly assign connecting elements during the manufacturing process and operation

The coding elements and locking devices are inserted prior to assembly or during the cable assembly phase. The Weidmüller alternative: configure online using the variant configurator to precode prior to delivery. Incorrect assembly on the circuit board and incorrect plugging of connecting elements is no longer possible. The advantage: no troubleshooting during manufacture and no operational errors by the user.

General ordering data

Type	Order No.	Version	GTIN (EAN)	Qty.	Product data
BLZ/SL KO BK BX	1545710000	PCB plug-in connector, Accessories, Coding element, Black, No. of poles: 1	4008190087142	50 pc(s).	
BLZ/SL KO OR BX	1573010000	PCB plug-in connector, Accessories, Coding element, Orange, No. of poles: 1	4008190048396	100 pc(s).	

Additional accessories



No task is too small when creating the perfect solution.

Connections form just one part of the overall process. Small details are often the key to the perfect solution in applications where potentials are tested, grouped or even isolated.

A system is not a system without small but useful details:

- Test plugs - ensure reliable pick-up from diagnostic sockets
- Cross-connectors - ensure a stable electrical distribution contact directly at the connection
- Compartment partition elements - divide a large number of male connectors into several separate socket connector channels
- Locks and clips - optional vibration-resistant clip-on connection or mounting for male and female connectors

In tandem with the manufacturing process and application - more accessories = smaller workload

General ordering data

Type	Order No.	Version	GTIN (EAN)	Qty.	Product data
SL AT SW	1770240000	PCB plug-in connector, Accessories, Partition	4032248117710	100 pc(s).	

Data sheet**OMNIMATE Signal - series BL/SL 5.08
SL-SMT 5.08HC/06/270FL 3.2SN BK BX**

Weidmüller Interface GmbH & Co. KG
Klingenbergstraße 16
D-32758 Detmold
Germany
Fon: +49 5231 1429-0
Fax: +49 5231 14292083
www.weidmueller.com

Accessories

		element, Black, No. of poles: 1	
SL AT OR	1598300000	PCB plug-in connector, Accessories, Partition element, Orange, No. of poles: 1	4008190189266 100 pc(s).

Recommended wave soldering profiles

Weidmüller Interface GmbH & Co. KG
 Klängenbergstraße 16
 D-32758 Detmold
 Germany
 Fon: +49 5231 14-0
 Fax: +49 5231 14-292083
 www.weidmueller.com

Single Wave:

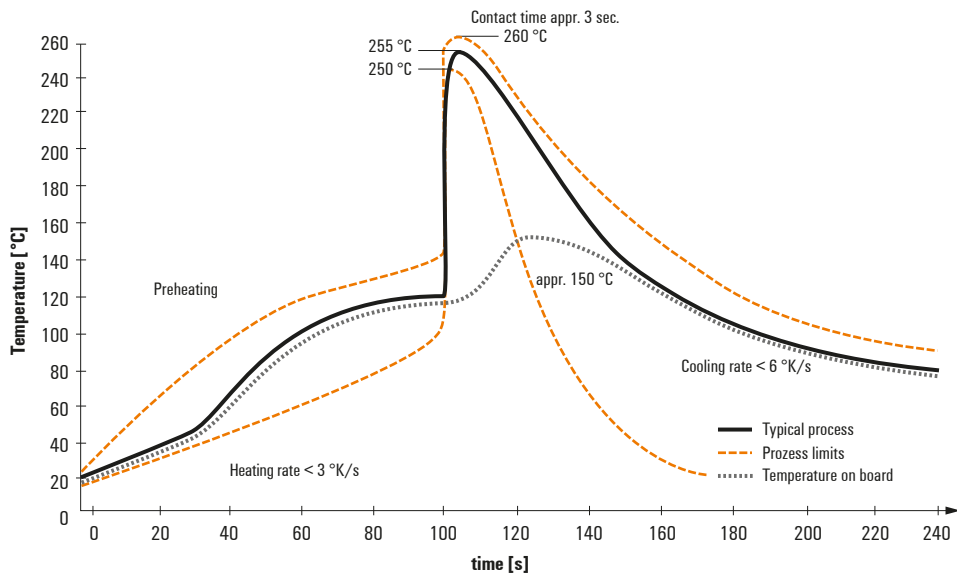

Double Wave:

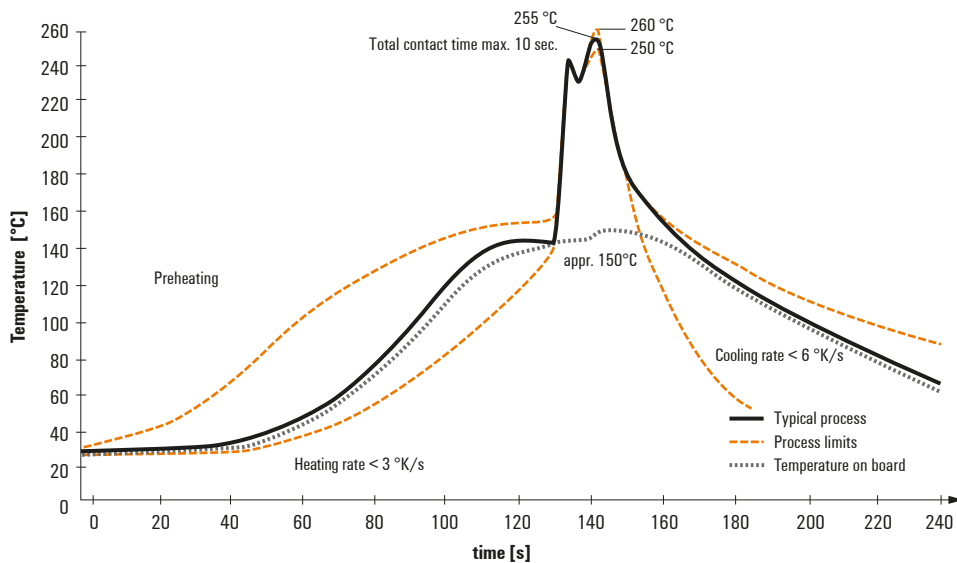

Wave soldering profiles

Wired connection elements should be processed in accordance with the DIN EN 61760-1 standard. We have included two recommendations for practical wave soldering profiles, with which Weidmüller PCB terminals and connectors are qualified.

When choosing a suitable profile for your application, the following factors also need to be considered:

- PCB thickness
- Proportion of Cu in the layers
- Single/double-sided assembly
- Product range
- Heating and cooling rates

The single and double wave profiles each indicate the recommended operating range, including the maximum soldering temperature of 260°C. In practice, the maximum soldering temperature is quite often well below the above maximum profile.

Recommended reflow soldering profile

Weidmüller Interface GmbH & Co. KG
 Klingenbergstraße 16
 D-32758 Detmold
 Germany
 Fon: +49 5231 14-0
 Fax: +49 5231 14-292083
 www.weidmueller.com

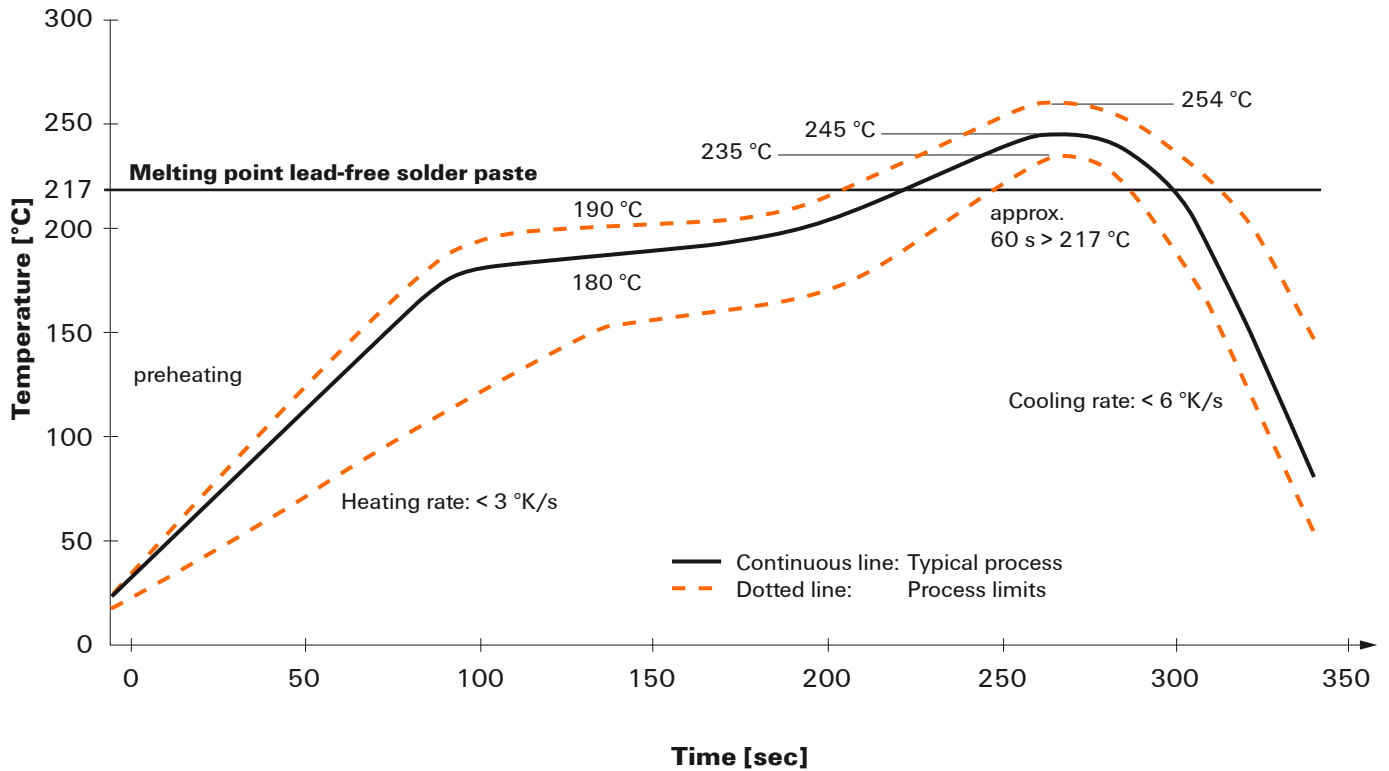

Reflow soldering profile

The perfect soldering profile for SMT Surface Mount Technology is one the most exiting question in SMT production. But there are more than one correct answer: The diagram of temperature-on-time is related to processing features of solder paste and to maximum load of components.

We have to consider the following parameters:

- Time for pre heating
- Maximum temperature
- Time above melting point
- Time for cooling
- Maximum heating rate
- Maximum cooling rate

We recommend a typical solder profile with associated process limits. With preheating components and board are prepared smoothly for the solder phase. Heating rate is typically $\leq +3\text{K/s}$. In parallel the solder paste is ‚activated‘. The time above melting point of 217°C the paste gets liquid and components and boards begin to connect. The maximum temperature of 245°C to 254°C should stay between 10 and 40 seconds. In the cooling phase at $\geq -6\text{K/s}$ solder is cured. Board and components cool down while avoiding cold cracks.

Addresses worldwide



Let's connect.

- AE United Arab Emirates**
Weidmüller Middle East FZE
Warehouse Q3-79
SAIF-Zone
P.O. BOX 8591
Sharjah
Telephone number +971 65572723
Fax number +971 65572724
wme.info@weidmueller.com
- AO Angola**
Please contact
Phambili Interface
South Africa
- AR Argentina**
CPI SA
Bauness 2660
C1431DOF Buenos Aires
Telephone number +54 11 4523 8008
Fax number +54 11 4522 0546
info@cpi.com.ar
www.cpi.com.ar
- AT Austria**
Weidmüller GmbH
IZ NOE Süd, Str 2b, Obj M59,
2355 Wiener Neudorf
Telephone number +43 2236 67080
Fax number +43 2236 6708-899
office.at@weidmueller.com
www.weidmueller.com
- AU Australia**
Weidmüller Pty. Ltd.
PO BOX 6944
Huntingwood 2148
Huntingwood Drive 43
Huntingwood NSW 2148
Telephone number +61 2 9671 9999
Fax number +61 2 9671 9911
info@weidmuller.com.au
www.weidmuller.com.au
- AZ Azerbaijan**
Representative Office
Weidmüller Interface
Demirchi Tower, 4th floor
37, Khojali ave.
AZ 1025 Baku
Telephone number +994 12 488 80 36
Fax number +994 12 488 80 37
aliyar.hashimli@weidmueller
- BA Bosnia and Herzegovina**
Please contact
our Representative Office
Weidmüller Interface GmbH
& Co. KG
Serbia
or
BIG electric d.o.o
Mladena Stojanovića 117A
78000 Banja Luka
Telephone number +387 51926277
Fax number +387 51926277
bigelectric@blic.net
www.bigelectric.ba
- BE Belgium**
Weidmüller Benelux B. V.
Mechelsesteenweg 519 bus
6 en 7
1930 Nossegem
Telephone number +32 2 752 40 70
Fax number +32 2 751 36 06
info@weidmueller.be
www.weidmueller.be
- BG Bulgaria**
Weid-Bul EOOD
Bul. "Kliment Ohridski" 13
1756 Sofia
Telephone number +359 2 963 2560
Fax number +359 2 963 1098
sofia@weidbul.com
www.weidbul.com
- BH Bahrain**
Khayber Trading Company
P.O Box 1976
Manama
Telephone number +973 720747
Fax number +973 720331
khayber@batelco.com.bh
- BR Brazil**
Weidmüller Conexel do Brasil
Conexões Elétricas Ltda.
Av. Presidente Juscelino, 642
- Piraporinha
Diadema, São Paulo
09950-370
Telephone number +55 (11) 4366-9600
Fax number +55 (11) 4362-1677
vendas@weidmueller.com.br
www.weidmueller.com.br
- BW Botswana**
Please contact
Phambili Interface
South Africa
- BY Belarus**
TECHNIKON Ltd.
Nezavisimosti pr. 177-9
220125 Minsk
Telephone number +375 17 393-11-77
Fax number +375 17 3930080
wm@technikon.by
- CA Canada**
W Interconnections Canada
Inc.
10 Spy Court
Markham Ontario L3R 5H6
Telephone number +1 (905) 475-1507 Ext. 9836
Fax number +1 (905) 475-2798
support@weidmuller.ca
www.weidmuller.ca
- CG Congo**
Please contact
Phambili Interface
South Africa
- CH Switzerland**
Weidmüller Schweiz AG
Rundbuckstraße 2
8212 Neuhausen am
Rheinfall SH
Telephone number +41 52 674 07 07
Fax number +41 52 674 07 08
info@weidmueller.ch
www.weidmueller.ch
- CL Chile**
ATS - INTECH
María Luisa Santander 0475
Santiago
Providencia 7500859
Telephone number +56 2 341 1271
Fax number +56 2 341 1275
felipe@atsintech.com
www.atsintech.com
CPI CHILE LTDA
Av. Presidente Frei Montalva
6001, 47 complejo el cortijo
Santiago - Conchalí
Telephone number +562 963 8440
Fax number +562 963 8440
cpi@cpichile.cl
www.cpiichile.cl
- CN China**
Weidmüller Interface
(Shanghai) Co. Ltd.
100 Yutong Road
25 F, BM Intercontinental
Business Center
200070 Shanghai
Telephone number +86 21-22195008
Fax number +86 21-22195009
customer.hotline@weidmueller.com.cn
www.weidmueller.com.cn
- CO Colombia**
Automatización Avanzada
S. A.
Carrera 97 No., 24 c - 23
Bodega 4
110911 Bogotá-D.C.
Telephone number +57 (1) 547-8510
Fax number +57 (1) 422-3044
comercial@automatizacionavanzada.com
www.automatizacionavanzada.com
- CR Costa Rica**
ELVATRON S. A.
la Uruca 400 Norte Banco
Costa Rica
San Jose Costa Rica
Telephone number +506 2961-060
Fax number +506 5200-609
dirk.haase@elvatron.com
www.elvatron.com
- CZ Czech Republic**
Weidmüller s.r.o.
Lomnického 5/1705
140 00 Praha 4
Telephone number +420 244 001 400
Fax number +420 244 001 499
office@weidmueller.cz
www.weidmueller.cz
- DE Germany**
Weidmüller GmbH & Co. KG
Ohmstraße 9
32758 Detmold
Postfach 30 54
32720 Detmold
Telephone number +49 5231 1428-0
Fax number +49 5231 14-292083
weidmuller@weidmueller.de
www.weidmueller.de
- DK Denmark**
Weidmüller Danmark
Vallensbækvej 18A
2605 Brøndby
Telephone number +45 27747800
kundeservice@weidmuller.dk
www.weidmuller.dk
- DZ Algeria**
SARL INTER ELECTRIC
1a Angles des Rues Okba Ibn
Nafaa et Hassi Beida
2300 Annaba
Telephone number
Fax number
contact@inter-electric.com
- EC Ecuador**
Elsystec S. A., Electricidad
Sistemas y Tecnología
Vasco de Contreras N35-251
y Manosca
Quito - Pichincha
Telephone number +593 22456510
Fax number +593 22456755
Elsystec@uio.satnet.net
- EE Estonia**
Please contact
our Representative Office
Weidmüller Interface GmbH
& Co. KG
Latvia
or
Soots Interface OÜ
Pärnu mnt 142
11317 Tallinn
Telephone number +372 609 6933
Fax number
info@sootsinterface.ee
www.sootsinterface.ee
- EG Egypt**
Standard Electric (OMEGA)
1, Abdelhamid Badawy Street
Heliopolis
Cairo
Telephone number +202 21805600
Fax number +202 21805600
stdelec@rite.com
- ES Spain**
Weidmüller, S. A.
Narcís Monturiol 11-13, Pol.
Ind. Sudoeste
8960 Sant Just
Desvern - Barcelona
Telephone number +34 934 803 386
Fax number +34 933 718 055
weidmuller@weidmuller.es
www.weidmuller.es
- FI Finland**
Weidmüller Suomi,
Weidmüller Aktiebolagetin
sivuliike
Koy Plaza Vivace
Äyritie 8C
FI 15100 Vantaa
Telephone number +358 20 7351300
Fax number +358 800 114 667
asiakaspalvelu@weidmuller.fi
www.weidmuller.fi
- FR France**
Weidmüller E. U. R. L.
12, Chaussée Jules César
BP 263 Osny
95523 Cergy-Pontoise Cedex
Telephone number +33 1 34 24 55 00
Fax number +33 1 34 24 55 01
mail@weidmuller.fr
- GB Great Britain**
Weidmüller Ltd.
Klippon House
Centurion Court Office Park,
Meridian East, Meridian
Business Park
Leicester
LE19 1TP
Telephone number +44 116 282 3470
Fax number +44 116 289 3582
marketing@weidmuller.co.uk
www.weidmuller.co.uk
- GE Georgia**
Please contact
our Representative Office
Weidmüller Interface
Azerbaijan.
- GH Ghana**
Please contact
our Representative Office
Weidmüller Interface GmbH
& Co. KG
South Africa.
- GR Greece**
G.A. Solutions
Ippokratous 11 Metamorfosi
144 52 Athen
Telephone number +30 210 2823233
Fax number +30 210 2823233
info@weidmuller.gr
www.weidmuller.gr
- GT Guatemala**
Prestelectro, Prestegard
Electro, S.A.
Avenida Petapa 44-22,
Zona 12
Guatemala City
Telephone number +502 2442-3346
Fax number +502 2476-8945
ventas@prestelectro.com
- HK Hong Kong**
Weidmüller (Hong Kong)
Limited Co. Ltd.
Unit 1617, Metropolis Tower
No. 10 Metropolis Drive,
Hunghom, Kowloon
Telephone number +852 3154 8088
Fax number +852 31548099
Info-hk@weidmueller.com.hk
- HR Croatia**
ElektroPARTNER d.o.o.
Slavonska avenija 24/6
HR-10000 Zagreb
Telephone number +385 (1) 6184 793
Fax number +385 (1) 6184 795
elektropartner@zg.t-com.hr
www.elektropartner.hr
- HU Hungary**
Weidmüller Kereskedelmi Kft.
Budapest
Gubacsi út 6.
1097
Telephone number +36 1 382 7700
Fax number +36 1 382 7701
info@weidmueller.hu
www.weidmueller.hu
- ID Indonesia**
PT. Nego Electrindo
Ruko Mega Grosir Cempaka
Mas Blok I No. 20 – 22
Jakarta 10640
Telephone number +62 21 42882255
Fax number +62 21 42882266
sales@negoelectrindo.co.id
- IE Ireland**
Please contact
Weidmüller Ltd.
Great Britain
- IL Israel**
A. U. Shay Ltd.
23/25, Embarr Street
49222 Petach-Tikva
P.O. Box 1 00 49
49222 Petach-Tikva
Telephone number +972 3-923-3601
Fax number +972 3-923-4601
shay@uriel-shay.com
www.uriel-shay.com
ATEKA Ltd.
4, Ha Tavor lane Industrial
area Segula
49691 Petach-Tikva
P.O. Box 4710
Petach-Tikva
Telephone number +972 73-200-1311
Fax number +972 3-924 4245
marketing@ateka.co.il
www.ateka.co.il
- IN India**
Representative Office
Weidmüller Electronics India
Pvt. Ltd.
No. 9, Union Street, Off.
Infantry Road
BANGALORE
560 001
Telephone number +91-80-22860028
wmi@weidmueller.in
www.weidmueller.com
- IR Iran**
Representative Office
Tamin Ehtiajat Fanni Tehran
(TAF Co.)
Unit #. 5, No. 62 Iranshahr
Ave.
Tehran - 15816-53717, Iran
Telephone number +9821 8831 7851
info@taf-co.com
http://www.taf-co.com
- IS Iceland**
Samey Automation Center
Lyngas 13
210 Garoabaer
Telephone number +354 510 5200
Fax number +354 5 10 5201
Samey@samey.is
www.samey.is
- IT Italy**
Weidmüller S. r.l.
Via Albert Einstein 4
20092 Cinisello
Balsamo Milano
Telephone number +39 02 660681
Fax number +39 02 6124945
weidmuller@weidmuller.it
www.weidmuller.it
- JM Jamaica**
Please contact
W Interconnections Inc.
United States



You can find all Weidmüller addresses and your local contact on the internet at: www.weidmuller.com/countries

Let's connect.

Sales company 
Representation abroad 
without representation abroad 

- JO Jordan**
Trans Jordan for Electro
PO Box 33 06 07
Amman
Telephone number +962 6 533 2020
Fax number +962 6 533 5800
transjordan@batelco.jo
- JP Japan**
Nihon Weidmüller Co. Ltd.
Sphere Tower Tennoz 2-2-8
Higashi-Shinagawa,
Shinagawa-ku
Tokyo
140-0002
Telephone number +81 3 6711 5300
Fax number +81 3 6711 5333
weidmullerjapan@weidmuller.co.jp
www.weidmuller.co.jp
- KE Kenya**
Please contact our Representative Office Weidmüller Interface GmbH & Co. KG South Africa.
- KG Kyrgyzstan**
Please contact our Representative Office Weidmüller Interface Azerbaijan.
- KR Korea**
Weidmuller Korea Co. Ltd.
9th floor
429, Teheran-ro, Gangnam-Gu
Seoul 135-721
Telephone number +82 2-516-0003
Fax number +82 2-516-0090
info@weidmuller.co.kr
www.weidmuller.co.kr
- KW Kuwait**
Kana Controls General Trading & Contracting Co. W. L. L.
Al Rai Industrial Area, Plot 28-30, St. 31
13016 Safat
B.P. 25593
Telephone number +965 4741373
Fax number +965 4741537
info@kanacontrols.com
- KZ Kazakhstan**
Please contact Weidmüller Group Russia
- LB Lebanon**
Progress Engineering & Trading Enterprises
Al Nahr Street
Beirut 11-1111
Telephone number +961 1 444 664
Fax number +961 1 561 880
progress@inco.com.lb
- LT Lithuania**
Please contact our Representative Office Weidmüller Interface GmbH & Co. KG Latvia
or
ELEKTROS IRANGA
Tinklu g. 29 a
LT-5319 Panevezys
Telephone number +370 (45) 582 828
Fax number
info@eliranga.lt
- LU Luxembourg**
Please contact Weidmüller Benelux B. V. Netherlands
- LV Latvia**
SIA Abi4
Daugavgrivas 31b
Riga, LV-1007
Telephone number +371 674 70999
Fax number +371 676 24562
abi_4@tvnet.lv
Representative Office Weidmüller Interface GmbH & Co. KG
Udens str. 12-118
Riga, LV-1007
Telephone number +371 29254766
Fax number +371 674 65637
Ilgonis.rudaks@weidmuller.com
www.weidmuller.com
- MA Morocco**
Sofimed
137, Bd Moulay Ismail Roches Noires
20290 Casablanca
Telephone number
Fax number
contact@sofimedmaroc.com
- MD Moldova**
BERHORD A & D srl
79/1, str. Milescu Spartaru
MD-2075 Chisinau
Moldova
Telephone number +373 (22) 815002
Fax number +373 (22) 815007
atiuleanu@berhord.com
www.ad.berhord.com
- ME Montenegro**
Please contact our Representative Office Weidmüller Interface GmbH & Co. KG Serbia.
- MG Madagascar**
Please contact Phambili Interface South Africa
- MK Macedonia**
Please contact our Representative Office Weidmüller Interface GmbH & Co. KG Serbia
or
ELEKTRO - SMK doool
UL. III Makedonska brigada
b.b.
1000 Skopje
Telephone number +389 22460295
Fax number
Elektro-smk@telelab.net.mk
- MN Mongolia**
Please contact our Representative Office Weidmüller Interface Azerbaijan.
- MT Malta**
E. S. S., Electrical Supplies & Services Ltd.
San Gwakklin Road
Mriehel
Telephone number +356 21255777
Fax number +356 21255999
robert.agius@ess.com.mt
- MU Mauritius**
Mubelo Electrical Ltd.
Office 26, Gateway building,
St Jean Road
Quatre Bornes
Mauritius
Telephone number +230 4670989
Fax number +230 4654051
richard.mubelo@orange.mu
- MW Malawi**
Please contact our Representative Office Weidmüller Interface GmbH & Co. KG South Africa.
- MX Mexico**
W Interconnections S. A.
DE C. V.
Blvd. Hermanos Sardán 698,
Col. San Rafael Oriente
72029 Puebla
Telephone number +52 (222) 268 6227
Fax number +52 (222) 286 6242
clientes@weidmuller.com.mx
- MY Malaysia**
Connect Plus Technology Sdn Bhd
No. 43, Jalan PJS 11/22,
Bandar Sunway
46150 Petaling Jaya
Selangor Darul Ehsan
Telephone number +60 3 5633 7363
Fax number +60 3 5633 6562
paul@cpstech.com.my
www.cpstech.com.my
- MZ Mozambique**
Please contact Phambili Interface South Africa
- NA Namibia**
Please contact Phambili Interface South Africa
- NG Nigeria**
Please contact Weidmüller Interface GmbH & Co. KG South Africa
- NL Netherlands**
Weidmüller Benelux B. V.
Franciscusweg 221
1216 SE Hilversum
P.O. Box 1505
1200 BM Hilversum
Telephone number +31 35 623 20 44
Fax number +31 35 623 20 44
info@weidmuller.nl
www.weidmuller.nl
- NO Norway**
Sivilingeniør J.F. Knudtzen AS
Billingstadsletta 97
1396 Billingstad
PO Box 160
1378 Nesbru
Telephone number +47 66 98 33 50
Fax number +47 66 98 09 55
firmapost@jfkknudtzen.no
www.jfkknudtzen.no
- NZ New Zealand**
Cuthbert S. Steward Ltd.
27 Te Puni Street
Petone
PO Box 38496
Wellington Mail Centre 5054
Telephone number (04) 568 6156
Fax number (09) 489 1752
csl@cuthbertsteward.co.nz
Cuthbert S. Steward Ltd
4 Fred Thomas Drive
Aon Building, Ground Floor,
South Entry
Takapuna
PO Box 100 338
North Shore City 745
Telephone number (09) 489 1751
Fax number (04) 568 6056
cslak@cuthbertsteward.co.nz
- OM Oman**
DAN INTERNATIONAL LLC.
Ghala St. 111
BP 2901
Seeb
Telephone number +968 5036 77
Fax number +968 5037 55
yedu@danintl.com
- PE Peru**
IMPEXINCA S.A.C.
Calle Ortiz de Zevallos No.
105, Urb. San Antonio
18
Lima, Miraflores
Telephone number +51 1 447 5608
info@impexinca.pe
www.impexinca.pe
J & W CIA, S. A.
Calle 6 Mz. D Lte. 23, Urb.
Ind. Grimanesa
01
Callao
Telephone number +51 1 572 2539
Fax number +51 1 572 0152
contacto@jwcia.com
www.jwcia.com
- PH Philippines**
Enclosure Systems Specialists Inc.
2276 Don Chino Roces
Avenue Extension
Room 103/105 Narra Building
1231 Makati City
Telephone number +63 2 813 8580
Fax number +63 2 813 8596
sales_encsys@pldtdsl.net
www.enclosuresystemsph.com
- PK Pakistan**
Automation Controls (Pak)
Apartment No. 33 C III,
Chenab Block, Allama Iqbal
Town
Lahore
Telephone number +92 42 37809948
Fax number +92 42 37809950
nadeem@acpak.com.pk
www.acpak.com.pk
- PL Poland**
Weidmüller Sp. z. o. o.
ul. Ogrodowa 58
00-876 Warszawa
Telephone number +48 22 510 09 40
Fax number +48 22 510 09 41
biuro@weidmuller.com.pl
www.weidmuller.pl
- PR Puerto Rico**
Please contact W Interconnections Inc. United States
- PT Portugal**
Weidmüller Sistemas de Interface S. A.
Estrada Outeiro Polima, R.
Augusto Dias da Silva, Lote B - Esc. 2
São Domingos de Rana
2785-515 Abóboda
Telephone number +351 214 459 191
Fax number +351 214 455 871
weidmuller@weidmuller.pt
www.weidmuller.pt
- PY Paraguay**
Please contact CPI SA Argentina
- QA Qatar**
Doha Motors
PO Box 145
Telephone number +974 4651441
Fax number +974 4654579
dmtctech@qatar.net.qa
<http://www.dohamotorsgroup.com/td.html>
Petroleum Technology Co. W.L.L.
PO Box 16069
5th Floor Toyota tower
Telephone number +974 44419603
Fax number +974 44419604
petrotec@qatar.net.qa
www.petrotec.com.qa
- RO Romania**
Representative Office Weidmüller Interface GmbH & Co. KG
Ionescu Crum Street, No. 1, 1st Tower, 1st Floor,
Office 4
500446 Brasov - Brasov
Business Park
Telephone number +40 (268) 446 222
Fax number +40 (268) 446 224
claudiu.totea@weidmuller.com
www.weidmuller.ro
- RS Serbia**
Representative Office Weidmüller Interface GmbH & Co. KG
Ustanicka 189, III sprat lokal 7a
11050 Beograd
Telephone number +381 112885274
Fax number +381 112885274
zoran.rabrenovic@weidmuller.com
Tela Elektrik d.o.o.
Ul. Dr. Džaga Ljodić 6
Beograd
Telephone number +381 11 2772 415
Fax number +381 11 2772 850
office@tela.rs
www.tela.rs
- RU Russia**
Weidmüller Group
7/10 Khlebozavodskiy
Passage,
Moskau
115230
Telephone number +7 495 280 72 71
Fax number +7 495 280 72 71
Info@weidmuller.ru
www.weidmuller.ru
- SA Saudi Arabia**
Al Abdulkarim Holding Co.
P.O. Box 4
Dammam 31411
Telephone number +966 3 8337110
Fax number +966 3 8829547
E-mail salehsk@akh.com.sa
www.weidmuller.ae
Saudi Electric Supply Company (SESCO)
P.O. Box 32 98
Al Khobar 31952
Telephone number +966 3 6829546 Ext. 3030
Fax number
E-mail Safdar.Malik@sescogex.com
www.sescogex.com
- SE Sweden**
Weidmüller AB
Axel Danielssons väg 271
BOX 31025
SE-200 49 Malmö
Telephone number +46 77-143 00 44
Fax number +46 40-37 48 60
info@weidmuller.se
www.weidmuller.se
- SG Singapore**
Weidmüller Pte. Ltd.
70 Bendemeer Road
04-03 Luzerne Building
Singapore 339940
Telephone number +65 6841 5311
Fax number +65 6841 5377
info@weidmuller.com.sg
www.weidmuller.com.sg
- SI Slovenia**
Elektrospoji d. o. o.
Stegne 27
SI- 1000 Ljubljana
Osrednjeslovenska
Telephone number +386 1 511 3810
Fax number +386 1 511 1604
info@elektrospoji.si
www.elektrospoji.si

Addresses worldwide

Let's connect.

SK Slovakia
ELEKTRIS s.r.o.
Elektrárenská 1
831 04 Bratislava
Telephone number +421
2/4920 0113
Fax number +421 2/4920
0119
bratislava@elektris.sk

SV El Salvador
Prestegard Electro
11 Avenida Norte No. 240
Edificio Salazar No. 2
San Salvador
Telephone number +503
2271 1690
Fax number +503 2221
3851
prestegard@navegante.com.sv

SY Syria
Please contact
Weidmüller Middle East FZE
United Arab Emirates

SZ Swaziland
Please contact
Phambili Interface
South Africa

TH Thailand
Pisanu Engineering Co. Ltd.
Kwang Dingaeng, Khet
Dingaeng
800/2 Soi Trakulsuk, Asoke-
dindaeng Road
Dindaeng, Bangkok
10400
Telephone number +66 2
248 2896
Fax number +662 105 6301
ecsales@pisanu.co.th
www.pisanu.co.th

Representative Office
Weidmüller Pte. Ltd.
37/F, Sathorn Square Building
98 North Sathorn Road
Bangkok, Silom Bangrak
10500
Telephone number +66 2
105 6300
Fax number +66 2 642 9220
info@weidmuller.com.sg

TJ Tajikistan
Please contact
our Representative Office
Weidmüller Interface
Azerbaijan.

TM Turkmenistan
Please contact
our Representative Office
Weidmüller Interface
Azerbaijan.

TN Tunisia
Please contact
Weidmüller E. U. R. L.
France

TR Turkey
Weidmüller Elektronik Ticaret
Ltd. Sirketi
Kavacik Mah. Orhan Veli Kanik
Caddesi 9/1
34810 Beykoz / Istanbul
Telephone number +90 (216)
537 10 70
Fax number +90 (216) 537
10 77
info@weidmuller.com.tr
www.weidmuller.com.tr

TW Taiwan
Please contact
Weidmüller (Hong Kong)
Limited Co. Ltd.
Hong Kong

TZ Tanzania
Please contact
our Representative Office
Weidmüller Interface GmbH
& Co. KG
South Africa.

UA Ukraine
LLC WM UKRAINE
Levanevskogo str. 6
Kiev
3058
Telephone number +38 044
490 32 48
Fax number
info@wm-ua.com.ua
wm-ua.com.ua/

Representative Office
Weidmüller Interface GmbH
& Co. KG
Z. office 303
7-D, Zdolbunivska str.
Kiev, 2081
Telephone number
(mobile) +38 050 440 25 24
info.ua@weidmueller.com

US United States
W Interconnections Inc.
821 Southlake Boulevard
Richmond Virginia 23236
Telephone number +1 (804)
794-2877
Fax number +1 (804) 379-
2593
info@weidmuller.com
www.weidmuller.com

UY Uruguay
REWU Uruguay S. A.
AV. Bolivia 2001Esq
Rocafuerte
11300 Carrasco Montevideo
Telephone number +598
2604 8439
Fax number +598 2604
8439
rewo@rewoouruguay.com.uy

UZ Republic of Uzbekistan
Please contact
our Representative Office
Weidmüller Interface
Azerbaijan.

VE Venezuela
Somerinca C. A.
Corazon de Jesus - 3ra
Transversal con calle el
Carmen- Los Dos Caminos
Caracas 1070-A
Telephone number +58
2122352748
Fax number +58
2122399341
klocmoeller@cantv.net
www.somerinca.com

VN Vietnam
ALUMI Industrial Equipment &
Automation Company Limited
E1, La Thanh Hotel
218 Doi Can Street
Lieu Giai Ward, Ba Dinh
District
Hanoi City
Telephone number +84 4
37628601
Fax number +84 4
62661391
aumi@aumi.com.vn
www.aumi.com.vn

Representative Office
Weidmüller Pte. Ltd.
Level 16 Saigon Tower
Building
29 Le Duan Street
District 1
Ho Chi Minh
Telephone number +848
3520 7717
Fax number +848 3520
7604
info@weidmuller.com.sg

ZA South Africa
Phambili Interface
PO Box 193
1609 Johannesburg, Edenvale
5 Bundo Road, Sebenza
1610 Johannesburg
Telephone number +27 (11)
4521930
Fax number
info@weidmuller.co.za
www.weidmuller.co.za

Representative Office
Weidmüller Interface GmbH
& Co. KG
210 Amarand
Avenue, Pegasus Building
181 Pretoria, waterkloof Glen
ext 2 -
Telephone number +27 12
003 2906
Fax number +27 (11)
4526455
Jacques.Vosloo@weidmueller.
com
www.weidmueller.com

ZM Zambia
Please contact
Phambili Interface
South Africa

ZW Zimbabwe
Please contact
Phambili Interface
South Africa